

AMENDED AND RESTATED LEASE AGREEMENT

Between

CITY OF FORT LAUDERDALE

and

MNREH FLORIDA, LLC

Date Amended and Restated Lease Term Commences: JANUARY 10, 2023

Initial Term: APRIL 1, 2005 – MARCH 31, 2035

Exhibits:

Exhibit A..... Leased Premises

Exhibit B..... Required Federal Provisions

Exhibit C..... Lessee Required Improvements

**AMENDED AND RESTATED LEASE AGREEMENT WITH THE
CITY OF FORT LAUDERDALE AND MNREH FLORIDA, LLC**

THIS AMENDED AND RESTATED LEASE AGREEMENT is made and entered into this ____ day of _____, 20__ (the "Effective Date"), and is by and between the **CITY OF FORT LAUDERDALE, FLORIDA** whose address is 100 North Andrews Avenue, Fort Lauderdale, Florida 33301 (hereinafter referred to as the "City" or "Lessor") and MNREH FLORIDA, LLC ("MNREH"), a Florida Limited Liability Company whose principal address is 84 Isla Bahia Drive, Fort Lauderdale, Florida 33301 (hereinafter referred to as the "Lessee").

NOW THEREFORE, for and in consideration of the mutual promises and covenants set forth herein and other good and valuable consideration, the City and the Lessee agree as follows:

RECITALS:

WHEREAS, the City owns and operates the Fort Lauderdale Executive Airport, located in Fort Lauderdale, State of Florida; and

WHEREAS, the City is desirous of leasing to Lessee and Lessee is desirous of leasing from the City, the real property located at Parcel 2A at the Fort Lauderdale Executive Airport in order to house a fleet of personal aircraft(s), fuel tanks, a hangar, an office and a storage area; and

WHEREAS, LESSOR has jurisdiction over the development, operation, and maintenance of the Fort Lauderdale Executive Airport; and

WHEREAS, LESSEE has made improvements to Parcel 2A at the Fort Lauderdale Executive Airport which consist of a new hangar with doors and metal panels, an application of new stucco on the office building, new HVAC equipment throughout the entire facility, a full remodel of the existing interior offices, a complete overhaul of the underground fuel storage system, the addition of new offices, new impact windows, the installation of a back-up generator, and new landscaping; and

WHEREAS, LESSOR finds that this Lease is in the best interest of the City of Fort Lauderdale and this is the most advantageous lease that the City can make at the time of the area involved; and

WHEREAS, pursuant to Resolution No. _____ adopted at its meeting of _____, the City Commission of the City of Fort Lauderdale authorized the proper City officials to enter into a Lease Agreement with MNREH FLORIDA, LLC for the lease of Parcel 2A at the Fort Lauderdale Executive Airport (hereinafter "Airport").

ARTICLE 1 DEFINITIONS

1.1 Definitions. The following words, terms and phrases, when used in Agreement, shall have the meanings ascribed to them in this section. Additional words and phrases used in this Lease but not defined herein shall have their usual and customary meaning.

Agency shall mean any federal, state, county, or local governmental entity, unit, organization, or authority.

Aircraft shall mean a device that is used or intended to be used for flight in the air.

Airfield shall mean those portions of the Airport, provided for the landing, taking off, and taxiing of aircraft, including without limitation, approach and turning zones, clear zones, aviation or other easements, runways, a fully integrated taxiway system, runway and taxiway lights, and other appurtenances related to the aeronautical use of the Airport, and such facilities may be modified from time to time.

Airport shall mean the Fort Lauderdale Executive Airport located in Broward County, Florida owned and operated by the City of Fort Lauderdale, including all real property, easements or any other property interest therein as well as all improvements and appurtenances thereto, structures, buildings, fixtures, and all tangible personal property or interest in any of the foregoing, also known as "FXE".

Airport Director means the Airport Director appointed by the City, including any person holding such position on an interim or acting basis, or the Airport Director's designee. Also known as "Airport Manager".

Airport Minimum Standards means the minimum standards adopted by the City and any amendment, restatement, or other modification to such minimum standards in effect from time to time.

Applicable Laws means all laws, statutes, ordinances, rules, codes, and regulations (including without limitation Environmental Laws) lawfully issued or promulgated by any Governmental Authority governing or otherwise applicable to the Airport (but not including the Rules and Regulations adopted by the City), as any of the same may now exist or may hereafter be adopted or amended, modified, extended, re-enacted, re-designated, or replaced from time to time and judicial interpretations thereof.

Aviation Advisory Board means the advisory board of the City created in accordance with Section 7-9 of the City of Fort Lauderdale Code of Ordinances.

Business Day means any day other than a Saturday, Sunday or holiday recognized by the City.

City or Lessor means the City of Fort Lauderdale, a municipal corporation organized and existing in Broward County, Florida.

City Commission means the City of Fort Lauderdale's governing body, as it may be changed from time to time.

City Manager means the person appointed by the City Commission responsible for the day-to-day operation of the City, or that person's designee.

City Party or City Parties means the City, its successors, and assigns, and each of its City Commission members, officers, officials, employees, agents, contractors, subcontractors, and volunteers.

Certificate of Occupancy Date or CO Date means the date(s) that any a certificate of occupancy is issued by the City and any other applicable governmental authority as it pertains to the buildings constructed on the Premises, or the Improvements constructed on the Premises.

Consumer Price Index or CPI means the consumer price index for all urban consumers (or "CPI-U") published by the U.S. Bureau of Labor Statistics for the most current 12-month period such data is available at the time of the applicable measurement or adjustment under this Lease. If CPI is no longer calculated by the U.S. Bureau of Labor Statistics, the City, in its sole discretion, shall select such other index as may be generally published that measures the increase in consumer costs, which index shall be substituted for CPI. Specific dollar amounts referenced in this Lease as being increased by CPI shall be adjusted by multiplying such amounts by a factor of one (1) plus the percentage increase (but not decrease), if any, in CPI during the most recently ended twelve-month period for which such CPI is available.

Effective Date has the meaning set forth in the initial paragraph of this Lease.

Environmental Laws shall mean and include all Federal, State of Florida and local statutes, ordinances, regulations and rules relating to environmental quality, health, safety, contamination and clean-up, as they currently exist or may exist in the future, including, without limitation, the Clean Air Act, 42 U.S.C. §7401 et seq.; the Clean Water Act, 33 U.S.C. §1251 et seq., the Water Quality Act of 1987; the Federal Insecticide, Fungicide, and Rodenticide Act ("FIFRA"), 7 U.S.C. §136 et seq.; the Marine Protection, Research, and Sanctuaries Act, 33 U.S.C. §1401 et seq.; the Noise Control Act, 42 U.S.C. §4901 et seq.; the Resource Conservation and Recovery Act ("RCRA"), 42 U.S.C. §6901 et seq., as amended by the Hazardous and Solid Waste Amendments of 1984; the Safe Drinking Water Act, 42 U.S.C. §300f et seq.; the Comprehensive Environmental Response, Compensation and Liability Act ("CERCLA"), 42 U.S.C. §9601 et seq., as amended by the Superfund Amendments and Reauthorization Act, and the Emergency Planning and Community Right to Know Act, and the Radon Gas and Indoor Air Quality Research Act; the Hazardous Material Transportation Act, 49 U.S.C. §9601 et seq.; the Toxic Substance Control Act ("TSCA"), 15 U.S.C. §2601 et seq.; the Atomic Energy Act, 42 U.S.C. §2011 et seq.; and the Nuclear Waste Policy Act of 1982, 42 U.S.C. §1010 et seq.; all State environmental protection, superlien and environmental clean-up statutes, with implementing regulations and guidelines and all local laws, regulations and

ordinances insofar as they are equivalent or similar to the Federal laws recited above or purport to regulate Hazardous Materials, and judicial precedent of each of the foregoing.

Event of Default or Default means each of the events or acts listed or described in this Lease Agreement as a default or breach or event of default.

Federal Aviation Administration (sometimes abbreviated as "FAA") means the Federal Aviation Administration created under the Federal Aviation Act of 1958, as amended, or any duly authorized successor agency thereto.

Fixture is an article which is physically annexed or affixed to the Leased Premises by way of bolts, screws, nails, glue, cement or other means and is incapable of being removed without structural or functional damaged to the Leased Premises. A fixture includes but is not limited to all of the following: toilets, sinks, lights, cabinets, ceiling fans, air conditioner, water heater, carpeting, drapery rods, automatic garage doors openers, garbage disposals, blinds, windows, window treatments, window shades, screens, screen doors, storm windows and doors, awnings, shutters, furnaces, heaters, heating equipment, stoves, refrigerators, washing machines, dryers, stovetop, dishwasher, ranges, oil and gas burners,

Governmental Authority means any Federal, State, county, municipal or other governmental entity (including the City in its governmental capacity), or any subdivision thereof, with authority over the Airport or aeronautical operations at or with respect to the Airport.

Gross Revenues means all revenues received or receivable by Lessee in connection with use of the Leased Premises including, without limitation, all rents, sales and receipts from sub-contracts, licenses and other agreements at or from the Leased Premises, regardless of when or where it is received and all fees, income and revenues of any type arising out of or in connection with the operations of Lessee at the Leased Premises, whether for cash or credit. The term "Gross Revenues" shall include without limitation any fees, income or revenue derived from the sale of products or the provision of any other services permitted herein. The following shall be excluded or deducted, as the case may be, from the computation of Gross Revenues:

- (1) any and all retail sales taxes, excise taxes, or related direct taxes paid by Lessee and received by proper taxing authorities in the course of such use of the Leased Premises;
- (2) sums received for any sales, use, luxury or excise tax, or any other tax, received by Lessee;
- (3) returns to shippers or manufacturers, wholesalers or distributors, for credit;
- (4) cash or credit refunds, but only to the extent that the services or merchandise sold was originally included in Gross Revenues;

- (5) proceeds from sales of fixtures which are not a part of the stock in trade of Lessee;
- (6) interest or carrying charges; and
- (7) sums and credits received in the settlement of claims for losses of or damage to merchandise.

Hangar means a building used to store aircraft(s) or a building used for the maintenance, repair, or refurbishment of aircraft(s), or storage of aircraft handling equipment including but not limited to towbars, glider tow equipment, workbenches, tools, or used for the storage of materials related to aeronautical activity.

Hazardous Materials shall mean and include any materials, substances, chemicals, or elements in any physical state (liquid, solid, gaseous/vapor) that are prohibited, limited, or regulated by Environmental Laws, or any other substances, chemicals, materials, or elements that are defined as “hazardous” or “toxic,” under Environmental Laws, or that are known or considered to be harmful, hazardous, or injurious to the human health or safety or the environment.

Initial Term shall have the meaning set forth in Article 3 of this Agreement.

Improvements or Leasehold Improvements mean any or all of the following but is not limited to: construction or addition of any buildings, structures, hangars, pavements, fixtures, permanently affixed equipment, new drywall and flooring, updates to lighting, updates to electrical systems, updates plumbing systems, updates to technology systems, or any other updates to systems, the addition or construction of facilities (both above ground and below ground), fences, landscaping, and all other structures now or hereafter constructed on the Premises, structural modifications, additions of rooms, cubicles, partitions, the addition of appliances, and all additions, alterations, modifications, renovations and replacements thereto.

Lease or Agreement means this Amended and Restated Lease Agreement (“herein “Lease Agreement”) dated as of the Effective Date between the City and Lessee, as amended in accordance with the terms of this Lease.

Leased Premises or Premises means the real property known as “Parcel 2A” at the Fort Lauderdale Executive Airport legally described in **Exhibit A**, attached hereto and incorporated herein, which includes but is not limited to and aircraft aprons, vehicle parking areas, landscaping, subject to all easements, rights-of-way of record, restrictions and declarations, together with all buildings, hangars, structures, pavements, facilities and other Improvements now or hereafter constructed thereon, the equipment permanently affixed therein, such as electrical, plumbing, sprinkler, fire protection and fire alarm, heating, steam, sewage, drainage, refrigerating, communications, gas and other systems and their pipes, wires, mains, lines, tubes, conduits, equipment and fixtures, and all paving, drains, culverts, ditches and catch basins.

Lender (also herein “mortgagee”) means a person or other entity authorized in accordance with the terms of this Lease Agreement to provide financing or refinancing to the Lessee.

Lessee means MNREH FLORIDA, LLC, a Florida Limited Liability Company, its successors and assigns that are approved in accordance with the Terms of this Lease Agreement.

Lessee Parties means, collectively, Lessee, and any of its officers, volunteers, representatives, agents, employees, contractors, subcontractors, licensees, subtenants, or suppliers.

Master Plan means the Fort Lauderdale Executive Airport Master Plan and any Update to the Master Plan that is in effect on the effective date of this Lease Agreement, and all amendments or replacements to said Master Plan or Update.

Part 150 Study means the Airport FAR Part 150 Program or Update thereto, that is in effect on the Commencement Date, and all amendments or replacements to said Study or Update.

Party means either the City (also “Lessor” herein) or Lessee and Parties refers to both the City and Lessee.

Person means a firm, association, partnership, company, estate, association, limited liability company, trust, corporation, joint venture, business enterprise, and other legal entities, including Governmental Authorities, as well as a natural person.

Rent Commencement Date means the initial date that rent is due on February 1, 2023, in accordance with this Lease Agreement.

Rules and Regulations means the lawful rules and regulations governing the conduct and operation of the Airport promulgated from time to time by the City, including without limitation, the City’s duly adopted and generally applicable Airport Minimum Standards, Operating Directives, Standard Procedures, and the Airport Security Plan, in each case as such may be in force and amended from time to time.

Runway(s) (including approaches thereto) mean the portion of the Airport utilized for the purpose of the landing and taking off of aircraft.

State means the State of Florida.

Taxiways mean the portion of the Airport utilized for the purpose of movement of aircraft to, from and between Runways, which includes but not limited to the public ramps, the apron area, the aircraft parking, and storage space.

Term shall mean the dates set forth in Article 3 of this Agreement.

"ULDR" means City of Fort Lauderdale, Florida, Unified Land Development Regulations" which herein may be to as the "ULDR".

1.2 Interpretation.

(a) References in the text of this Lease to articles, sections, or exhibits pertain to articles, sections or exhibits of this Lease, unless otherwise specified.

(b) The terms "hereby," "herein," "hereof," "hereto," "hereunder," and any similar terms used in this Lease refer to this Lease.

(c) Any headings preceding the text of the articles and sections of this Lease, and any table of contents or marginal notes appended to copies hereof, shall be solely for convenience of reference and shall not constitute a part of this Lease, nor shall they affect its meaning, construction, or effect.

(d) Words importing the singular shall include the plural and vice versa. The use of any gender shall include all genders.

(e) Except as otherwise specified herein, where the approval of the City is required under this Lease, the written approval of the Airport Director shall be required to evidence such approval.

1.3 Incorporation of Exhibits. The following Exhibits are hereby made a part of this Lease:

EXHIBIT A SURVEY AND LEGAL DESCRIPTION

EXHIBIT B REQUIRED FEDERAL PROVISIONS

EXHIBIT C LESSEE REQUIRED IMPROVEMENTS

ARTICLE 2 LEASED PREMISES AND MUTUAL REPRESENTATIONS AND WARRANTIES

2.1 Municipality. The Lessor is a municipal corporation organized and existing pursuant to the laws of the State of Florida.

2.2 Deed. On March 11, 1947, there was executed and delivered to the Lessor by the United States of America a Deed conveying to the Lessor certain land situated near the territorial limits of the City of Fort Lauderdale, known as Prospect Field, which deed of conveyance was recorded in Deed Book 579, Page 130, of the Public Records of Broward County, Florida ("Deed"). The Premises above described constitute a portion of the property acquired by the Lessor under said Deed. This Lease Agreement is subject to all the terms, conditions, restrictions and provisions of said Deed.

2.3 Leased Premises. Subject to the terms and conditions more fully set forth herein, City hereby leases to Lessee and Lessee hereby leases from City the “Leased Premises,” which shall consist of the real property legally described and depicted on **Exhibit A**.

2.4 Warranties; Condition Exemption for City. Lessee agrees that the Leased Premises is in an “AS IS” condition and the Lessee accepts the Leased Premises from the City in an “AS IS” condition. The City and Lessee agree that the City has not made any warranties or representations, express or implied, to Lessee with regard to the Leased Premises except as expressly provided hereunder. The Lessee acknowledges that the Lessor has made full disclosure of all facts reflected by the aforesaid Deed. Lessor makes no representations or warranties whatsoever as to: (i) the condition of the Premises; or (ii) whether the Premises, or any part thereof, is in compliance with applicable federal, state, and local laws, ordinances, rules and regulations, including without limitation, City ordinances, rules and regulations; or (iii) the permitted or available uses of the Premises under applicable federal, state, or local laws, ordinances, rules and regulations, including without limitation, those of City. Lessor makes no representations or warranties whatsoever as to the legality, permissibility or availability of any use of the Premises that may be contemplated by the Lessee. **Lessor makes no representations or warranties concerning habitability or fitness of the Premises for a particular purpose.** The Lessee specifically acknowledges that it has made, or has had an opportunity to conduct, a due diligent investigation of the Premises and the suitability thereof for Lessee’s purposes, and is fully advised of its extent and condition. The Premises and all components thereof, are hereby demised in “**AS IS CONDITION**” and “**WITH ALL FAULTS**” in the Premises’ present state and condition. Lessee represents, acknowledges, and agrees that it has had sufficient opportunity to inspect the Premises and all components thereof, and hereby accepts the Premises, and all components thereof, in “**AS IS CONDITION**” and “**WITH ALL FAULTS.**” Lessee **ASSUMES ALL RISK** of non-compliance of the Premises, or any part thereof, with any federal, state, or local laws, ordinances, rules and regulations, including without limitation, any City laws, ordinances, rules or regulations. Upon receipt of any notice of non-compliance with any such laws, ordinances, rules or regulations, Lessee agrees to make any and all repairs, alterations, and additions to the Premises and to take all corrective measures as may be necessary to bring the Premises into compliance with all laws, ordinances, rules and regulations. Lessee shall not be entitled to any adjustment of any rentals hereunder on account of the condition of the Premises; or any failure of any of the component parts to be in working order; or because of the necessity of Lessee to repair or take corrective actions with respect to any part thereof or because of the inability of obtaining or any delay in obtaining any required development approvals from any governmental agency having jurisdiction, including but not limited to City and its departments. Furthermore, Lessee hereby releases Lessor and City Parties of any and all claims and liabilities whatsoever on account of the condition of the Premises or any failure of any of the component parts to be in working order or because of the necessity of Lessee to repair or take corrective actions with respect to any part of the Premises, or the necessity for

obtaining any development approvals from any governmental agency, including the City and its departments.

2.5 Subject to Survey. All square footages referenced herein are estimates. A survey of the Leased Premises is attached as **Exhibit "A"** which is incorporated herein. Exhibit "A" includes the current square footage of the Premises. **Exhibit "A"** may be modified by an Amendment to this Lease Agreement which is subject to the approval of the City Commission at a public meeting and the Lessee and executed with the same formality herein.

2.6 Title. Title to the Leased Premises legally described in **Exhibit "A"** including any buildings and structures that were present on the Leased Premises at the commencement of this Lease Agreement is held by the City as of the Effective Date and shall remain with City at all times during the Term of this Lease. All improvements which will be or are constructed or erected on the Leased Premises including but not limited to any and all buildings, structures, Improvements and fixtures of every kind constructed, erected, or placed on the Leased Premises shall remain the property of the Lessee until the end of the term of the Lease Agreement or earlier termination of this Lease Agreement. On the date of the termination or expiration of the Lease Agreement, any and all improvements including but not limited to any and all buildings, structures, Improvements and fixtures of every kind constructed, erected or placed on the Premises shall become the property of the Lessor (shall be owned by Lessor). The Airport Director or his or her designee in his or her sole discretion may require Lessee to demolish any or all improvements, building(s), or structure(s) on the Leased Premises which are now existing or maybe constructed prior to the expiration or termination of the Lease Agreement. At the expiration or termination of the Lease Agreement, Lessee shall leave the Leased Premises in good condition and comply with all other additional requirements in this Lease Agreement.

ARTICLE 3 TERM

3.1 Term. As used in this Lease, the word "Term" includes the Initial Term, and each Extended Term, if any, if Lessee exercises any or all of its options to extend the Term pursuant to this Article.

3.2 Initial Term. The "Initial Term" of the Lease Agreement commenced on April 1, 2005. The effective date of this Amended and Restated Lease Agreement shall begin on the 10th day of January, 2023 ("Effective Date") and shall terminate March 31, 2035 unless terminated earlier in accordance with the terms of this Lease Agreement or extended in accordance with this Lease Agreement.

3.3 Option to Extend. Prior to the expiration or termination of the Lease Agreement, the Lessee may extend the Lease Agreement for an additional **ten years** (hereinafter referred to as "**Extended Term(s)**") **two** consecutive times (each an "**Extension Option**") for a total extension of twenty years, if the requirements listed below are met. Lessee's

right to exercise the aforementioned Extension Option(s) are subject to the following requirements:

(a) In order to exercise an Extension Option, Lessee must give the Airport Director - written notice of its intent to exercise such Extension Option, not more than three hundred and sixty-five (365) nor less than one hundred eighty (180) calendar days prior to the end of the Initial Term or Extended Term, whichever is applicable; and

(b) The Lessee must accept and agree to pay the increased Rent in accordance with the terms of this Lease Agreement which the Airport Director shall provide Lessee with written notice of; and

(c) During any Extended Term, if applicable, all provisions of this Lease shall remain in full force and effect; and

(d) An extension will not be granted unless the Lessee is not in breach or default of the Lease Agreement as determined by the Airport Director or his or her Designee; and

(e) Rent during any Extended Term shall be calculated in accordance with the terms of this Lease Agreement.

3.4 Return of Premises. Prior to Lease Termination, regardless of the circumstances upon which Lease Termination occurs, Lessee shall at its own expense: (i) return the Leased Premises to City in the same condition the Leased Premises were in on the Effective Date or if later improved, in the improved condition, and (ii) remove all of its personal property from the Leased Premises within thirty (30) days of the termination or expiration of the Lease Agreement. Lessee shall reimburse the City within ten (10) days of the Airport Director's request for any damages that occur to the Leased Premises caused by the Lessee or any third party from the removal of Lessee's personal property at the Leased Premises.

The Airport Director or his or her designee in its sole discretion may require the Lessee to demolish any improvements constructed by Lessee on the Leased Premises by sending written notice of requirement to demolish to the Lessee. If demolition is required by the Airport Director or his or her designee, Lessee shall post a bond or other financial security satisfactory to the Airport Director or his or her designee in an amount to be determined by the Airport Director in his or her sole discretion to ensure the completion of such demolition. Any items of Lessee's remaining in or on the Leased Premises thirty days after the expiration or termination of this Lease shall be deemed abandoned by Lessee and become the sole property of City. Notwithstanding the foregoing, any costs incurred by City in storing and/or disposing of such abandoned property shall remain the sole obligation of Lessee, which obligation shall survive the expiration or termination of this Lease. Lessee shall reimburse the City for any costs related to the removal, destruction, or storage of Lessee's personal property within 10 days of the City's written request. If the City elects to repair any damages to the Leased Premises, caused by or related to the removal of Lessee's personal property, Lessee

shall reimburse the City within ten (10) days of the Airport Director's written demand for any damages to the Leased Premises or the Airport caused or related to the removal of Lessee's personal property at the Leased Premises.

ARTICLE 4 USES AND RESTRICTIONS

4.1 Lessee shall use the Leased Premises solely for the renovation of an existing hangar, which will include new doors and metal panels, an application of new stucco on the office building, the installation of new HVAC equipment throughout the entire facility, a full remodel of the existing interior offices, a complete overhaul of the underground fuel storage system, the addition of new offices, new impact windows, the installation of a back-up generator, and new landscaping for the purpose of conducting its business housing a fleet of personal aircrafts, having fuel tanks, an office and storage area. Any other use of the Premises is prohibited unless the following requirements are met:

(a) This Lease Agreement is amended to include a different use and the amendment is approved by the City Commission at a public meeting and the Lessee also approves the amendment and the amendment is executed with the same formality herein; and

(b) The use is not prohibited by the City of Fort Lauderdale Code of Ordinances and not prohibited by the Unified Land Development Regulations and any other applicable law; and

(c) The use complies with and is in accordance with the Minimum Standards and the City's Rules and Regulations.

4.2 City and the City Parties assume no liability or responsibility whatsoever with respect to the use, conduct, or operation of the business to be conducted in and on the Leased Premises and shall not be liable for any loss, injury, or damage to property caused by or resulting from any variation, interruption, or failure of utility or other services due to any cause whatsoever, or from failure to make any repairs or perform any maintenance that is Lessee's responsibility pursuant to this Lease.

4.3 Lessee shall continuously occupy the Leased Premises throughout the Term of the Lease. All payments due to the City in accordance with the terms of this Lease Agreement, shall remain due and payable during any period that operations at the Leased Premises cease or are suspended and Lessee shall continue to maintain the Leased Premises, and keep utilities and services in place.

(a) The Premises shall not be used in any manner that is incompatible with or which violates any provision of any FAA rules, regulations or advisory circulars, state laws or regulations, or City ordinances, applicable county ordinances, administrative code provisions or regulations, as each is amended from time to time, and including without limitation FAA Advisory Circular No. 150/5300-13, Chapter 333, Florida Statutes, and Chapter 7 of the City of Fort Lauderdale Code of Ordinances. In addition, Lessee is

expressly prohibited from providing the following services and conducting the following uses:

- (b) Fixed Base Operator Services or sale of fuel.
- (c) Sale of non-aviation products and any use not related to aviation, other than the sale of company specialty items such as shirts, hats and other specialty items.
- (d) Air shows.
- (e) Carrying, storing, receiving or distributing hazardous materials.
- (f) Adult entertainment.
- (g) Any use, which conflicts with the Foreign Trade Zone (FTZ) activities and regulations.
- (h) Any other use prohibited by law.

ARTICLE 5 RENT, FEES, AND CHARGES

5.1 Rent, Fees, and Charges. Beginning on the Rent Commencement Date, Lessee shall pay the City "Rent" as set forth below. "Rent" as used in this Lease shall include Base Rent, Improvement Rent, Adjusted Improvement Rent, fees, charges, and any other amounts of money due to the City from Lessee in accordance with the terms of this Agreement. Lessee shall pay the City Rent in equal monthly installments, in advance, on or before the first (1st) day of each and every month in accordance with the following requirements (in addition to any other laws or provisions in this Agreement requiring the Lessee to pay the City):

(a) **Base Rent.** Lessee shall pay the City Base Rent equal to \$52,228.44 (\$0.55 per square foot) per year plus applicable State of Florida sales tax for the Leased Premises identified in **Exhibit "A"** attached to this Lease Agreement and incorporated herein. The Base Rent shall be paid by Lessee in equal monthly installments, without demand and in advance on or before the first (1st) day of the month, and on the first day (1st) of each month thereafter. Base Rent will be adjusted every ten years following the Effective Date to either ten percent (10%) of the appraised value of the land or the annual rental rate at that time, established by the most recently adopted City resolution, whichever is greater.

(b) **Improvement Rent.** On or about October 1, 2034, an appraisal of the land and Improvements on the Leased Premises will be performed to assist the Airport Director in establishing the Improvement Rent. The City will obtain an appraisal at its own cost and expense. The Airport Director will determine the amount of the Improvement Rent with the assistance of the appraisal and provide written notice of the Improvement Rent to Lessee. Lessee shall commence paying the City Improvement Rent on or before April 1, 2035 and every month thereafter for the remaining term of this Lease Agreement, as adjusted, in equal monthly installments, without demand and in advance on or before the first (1st) day

of the month, and on the first day of each month thereafter. Lessee and City agree that Improvement Rent is in addition to Base Rent. Lessee and City agree that Improvement Rent will be adjusted in accordance with the terms of this Lease Agreement (“Adjusted Improvement Rent”) and the Lessee shall pay the Adjusted Improvement Rent by the due dates in accordance with the terms of this Lease Agreement.

- (i) **Adjusted Improvement Rent.** On or about October 1, 2044, an appraisal of the land and Improvements on the Leased Premises will be performed to assist the Airport Director in establishing the Adjusted Improvement Rent to ensure consistency with market adjustments. The City will obtain an appraisal at its own cost and expense in order to establish the adjusted Improvement Rent in 2044. The Airport Director will determine the amount of the Adjusted Improvement Rent with the assistance of appraisal and provide written notice of the Adjusted Improvement Rent to Lessee. Lessee shall commence paying the City the Adjusted Improvement Rent on or before April 1, 2045 and every month thereafter for the remaining term of this Lease Agreement in equal monthly installments, without demand and in advance on or before the first (1st) day of the month, and on the first day of each month thereafter.

(c) **Fuel Flowage Fees.**

- (i) The LESSEE has the right to dispense aviation fuels and lubricating oils within the Premises, provided such aviation fuels and lubricating oils shall be the product of a supplier or suppliers holding all necessary permits, licenses, certifications or approvals required by the appropriate government agencies to conduct such operations and to deliver aviation fuels and lubricating oils to the Airport. Lessor shall in no way be prevented from granting exclusive rights for dispensing of aviation fuels and lubricating oils on premises other than those covered by this Lease under such terms and conditions as it may deem advisable. In connection with dispensing of such products upon the Premises or otherwise, Lessor assumes no responsibility for acts of any supplier regarding delivery, quality of product, or maintenance of supplier-owned or Lessee-owned equipment. Aviation fuels and lubricating oils shall be stored and dispensed by Lessee in accordance with all City, county, local, state, and federal laws, regulations, rules, and other requirements pertaining to the sale and storage of such fuels and oils, including but not limited to the Minimum Standards, as amended by the City from time to time.
- (ii) Aviation Fuel Fees - Lessee shall pay Lessor the following fees for all aviation fuel delivered to the Premises each month: Five and one-half percent (5.5%) of the total price per gallon of the first five hundred thousand (500,000) gallons of aviation fuel delivered to the Premises and three and one-half percent (3.5%) of the total price per gallon of

aviation fuel delivered to the Premises exceeding five hundred thousand (500,000) gallons of aviation fuel during the period of January 1st through and including December 31st of each calendar year. The first 500,000 gallons of aviation fuel will reset annually beginning January 1st of each calendar year. Aviation fuel is subject to applicable taxes under Florida Law.

- (iii) Lessee shall pay Lessor Aviation fuel fees monthly by no later than the 15th day of each month for the previous month without any additional grace period and accompanied by a monthly report prepared by Lessee, which report shall detail the gallon amounts of any and all fuel delivered to the Premises. Such monthly reports shall pertain only to the Lessee's operations conducted at the Airport and exclude any other operations of the Lessee conducted at other locations. Payment shall be delinquent upon the 16th day of the month, and upon such delinquency, the Lessee is subject to the default provisions in this Lease Agreement.
- (iv) The Lessee shall further retain upon the Premises all delivery bills, invoices, and related records pertaining to the delivery to the Premises of aviation fuels and lubricating oils and shall produce and make available such books and records upon request by the Lessor for the purposes of auditing payments to the Lessor as provided in this Lease. Such books, records and other documents shall be made available for inspection to representatives of Lessor within fifteen (15) days of written notice to Lessee. Lessor shall have the right, upon reasonable notice to Lessee, to audit the Lessee's books and records relating to Lessee's operations in order to determine the correctness and accuracy of the fuel fees paid to Lessor during a Lease year. In the event that any such audit reflects that the total fuel fees actually paid to Lessor during a particular Lease year shall be less than the fuel fees due and owing for such Lease year, then the Lessee shall immediately pay the difference to the Lessor upon written demand therefore by Lessor. If, as a result of any audit, it is established that the fuel fees paid to Lessor during a Lease year shall be three percent (3%) or more less than the fuel fees owed to the Lessor for such Lease year, the entire expense of said audit shall be borne by the Lessee. Lessor shall provide Lessee with a copy of the audit results obtained by Lessor after such written request by Lessee.
- (v) The term delivery to the Premises as used in this subparagraph shall mean delivery of aviation fuel to the Premises; this includes delivery of aviation fuel to Lessee, its employees, agents, sublessees, and independent contractors, but shall not apply when Lessee obtains aviation fuel from Fixed Based Operators at the Airport.

(d) **Audit Rights.** Lessee shall retain upon the Leased Premises all business records for its Gross Revenues, delivery bills, invoices, and related records pertaining to the delivery to the Leased Premises of aviation fuels and lubricating oils and shall produce and make available such books and records upon request by the City for the purposes of auditing payments to the City as provided in this Agreement. Such books, records and other documents shall be made available for inspection to city staff within fifteen (15) days of written notice to Lessee. The City shall have the right, upon reasonable notice to Lessee, to audit the Lessee's books and records relating to Lessee's operations in order to determine the correctness and accuracy of the Gross Revenues Rent and Fuel Flowage Fees paid to the City. In the event that any such audit reflects that the total Gross Revenue Rent and Fuel Flowage Fee actually paid to the City during a particular Lease Year is less than the Gross Revenue Rent and Fuel Flowage Fees due and owing for such Lease Year, then the Lessee shall immediately pay the difference to the City upon written demand therefore by the City. If, as a result of any audit, it is established that the Gross Revenue Rent and Fuel Flowage Fees paid to the City during a Lease Year shall be three percent (3%) or more less than the Gross Revenue Rent and Fuel Flowage Fees owed to the City for such Lease Year, the entire expense of said audit shall be borne by the Lessee. The City shall provide Lessee with a copy of the audit results obtained by the City upon such written request by Lessee.

- (i) The term "delivery to the Leased Premises," as used in this subparagraph, shall mean physical delivery of aviation fuel to the Leased Premises, whether to Lessee, its employees, agents, subleases and independent contractors, but shall not include instances when Lessee obtains aviation fuel from Fixed Based Operators at the Airport.

5.2 **Rental Adjustments.**

(a) **CPI Adjustments.** Commencing on the first month of the second (2nd) Lease Year, and each Lease Year thereafter, the Base Rent and Improvement Rent, if any, due under Section 5.1 of this Lease shall be adjusted to reflect cost of living increases based on the Consumer Price Index-Urban ("Index"). For purposes of calculating the Base Rent, the first (1st) Lease Year beginning on the Rent Commencement Date shall be referred to as the "Base Year." At such time as the calculation is being made the monthly index figure for the third (3rd) calendar month immediately preceding the end of the applicable adjustment date ("Adjusted Index") shall be used. The monthly Index figure for the calendar month immediately preceding the date of the Lease shall be referred to as the "Base Index." For each annual period, the adjusted fixed rent shall be computed by multiplying Base Year fixed rent by a fraction, the numerator of which shall be the Adjusted Index, and the denominator of which shall be the Base Index. Stated as a mathematical formula, the adjusted rent shall be computed as follows:

$$\text{Adjusted rent} = \frac{\text{Adjusted Index} \times \text{Rent for Base Year}}{\text{Base Index}}$$

In no event shall the Base Rent in effect be decreased as a result of such adjustment. The Rent rates following the adjustment shall remain in effect until the next adjustment. For clarification purposes, the adjustments will commence on April 1, 2024 and occur on the first day of each year during the term of this Lease Agreement. Written notice sent to the Lessee of calculations of CPI Adjustments are subject to the City's internal audit procedures and maybe revised accordingly.

Fair Market Rent Adjustment. On the tenth (10th) anniversary of the Rent Commencement Date and every ten years thereafter and at the commencement of each Extension Term (each an "Adjustment Date"), the Base Rent and the Improvement Rent shall be adjusted to the Fair Market Base Rent and Improvement Rent for the Leased Premises as determined by the following procedure:

No later than one hundred eighty (180) days prior to the commencement of the Adjustment Date, City will appoint one independent appraiser, whom shall be a professional M.A.I. appraiser with at least ten years' experience appraising aviation and industrial properties in the Southeast Florida market, and will provide an opinion of the Fair Market Base Rent and Improvement Rent for the first year of the Term commencing after the applicable Adjustment Date and will report such opinion to the Airport Director within thirty (30) days of the date of such appraiser's appointment. In determining Fair Market Base Rent and Improvement Rent, the appraiser shall take into account all relevant factors.

5.3 Failure to Pay Rentals, Fees or Charges. In the event Lessee fails to make timely payment of any rent, fees, charges, and payments due and payable in accordance with the terms of this Lease, a late fee of Two Hundred Dollars (\$200.00) per day shall accrue, in addition to the amount due, from the date due until the date payment is received by City. Notwithstanding the foregoing, City shall not be prevented from utilizing the remedies in Article 9 of this Lease.

5.4 Service Charge for Dishonored Checks. In the event Lessee delivers a dishonored check or draft to City in payment of any obligation arising under this Lease, Lessee shall incur a service charge of Twenty-five Dollars (\$25.00) or five (5) percent of the face amount of such check, whichever is greater.

5.5 Other Fees and Charges. Nothing contained in this Lease shall preclude City from establishing other reasonable and non-discriminatory fees and charges applicable to aircraft operating at the Airport, including aircraft owned or operated by Lessee, at such time as City deems appropriate. Lessee expressly agrees to pay such fees and charges as if they were specifically included in this Lease. In the event Lessee engages in any activity or provides any service at the Airport for which other companies operating at the Airport pay a fee to City, as consideration for permission to undertake such Additional Services, Lessee shall pay City fees equivalent to those paid by such other companies for engaging in such activities or providing such services.

5.6 Payments. Lessee shall pay all rents, fees, charges and billings required by this Lease in the United States of America currency, by wire transfer or automated

clearinghouse (“ACH”) transfer or any other electronic payment authorized by the City of Fort Lauderdale. Lessee shall remit all rents, fees, charges and billings payable to the “City of Fort Lauderdale”, which shall be delivered according to ACH and wire transfer instructions provided below as may be changed from time to time in writing by the Airport Director or his or her designee in accordance with the notice requirements in this Lease Agreement:

City of Fort Lauderdale

Bank Name -	Wells Fargo Bank N.A.
Bank Account Number -	2000016114577
Routing Number ACH -	121000248
Routing Number Wire -	121000248
Description -	Airport - Description of Payment
Bank Account Name -	City of Fort Lauderdale Master Account
Bank Contact -	Stephen Lenehan 450 S Australian Avenue, 7th Floor MAC Z6344-070 West Palm Beach, FL 33401
Phone Number -	561-650-2364
Fax Number	561-650-2367
Email -	stephen.lenehan@wellsfargo.com

Email MLaca@FortLauderdale.Gov with the following information:

- 1) Amount being sent
- 2) Date will be sent
- 3) City contact – **Miguel Laca**
- 4) Reason for payment

Rent is not considered paid, if the payment/ACH is rejected, does not clear, or is stopped for any reason. Cash will not be accepted by the City. The Airport Director or his or her designee in their sole discretion, may require at any time that Lessee pay all rent by certified check, cashier's check, or money order. All payment obligations under this Lease Agreement shall constitute Rent under this Lease Agreement. Lessee shall pay or reimburse the City for all bank charges or wire fees any funds sent to the City including fees assessed or charged by the City's bank or financial institution within five (5) days of the date that the fee is charged or assessed.

5.7 Transaction Fee. Lessee shall pay to the City as Transaction Fee (i) an amount equal to four percent (4%) of the Sale Proceeds from any Sales, and (ii) an amount equal to four percent (4%) of the Net Refinancing Proceeds of each Refinancing, any such amount to be paid simultaneously with the occurrence of the Sale or Refinancing (“Transaction Fee”).

Not less than five (5) days prior to the anticipated closing of a Sale or Refinancing of the Lessee's Leasehold (whether or not Lessee anticipates that the Sale or Refinancing will result in the obligation to pay Transaction Fee to the City). Lessee shall deliver a statement in reasonable detail to the City setting forth the estimated amount of

Transaction Fee anticipated to be due upon the closing of such Sale or Refinancing of the Leasehold, and the calculation thereof, based on costs and other amounts that are known to Lessee (or Lessee's good faith estimates thereof) as of the time of such statement. Such statement shall include an itemized estimate of the following: (a) the amount of the gross Sale Proceeds (without any deduction as provided for in the definition of "Sales Proceeds" contained in this Section 5.7 below) or Refinancing Proceeds; (b) with respect to a Refinancing, (i) the outstanding principal amount of the debt to be repaid with the Refinancing Proceeds, (ii) each of the other amounts deducted by Lessee from the amount of Refinancing Proceeds in accordance with the definition of "Net Refinancing Proceeds" set forth below in calculating the Net Refinancing Proceeds, together with reasonable supporting documentation therefor, (iii) the amount of Net Refinancing Proceeds resulting from the transaction, and (iv) the amount of Transaction Fee to be due in connection with the such Refinancing; and (c) with respect to a Sale, (i) each of the amounts deducted by Lessee from the amount of gross Sale Proceeds in accordance with the definition of "Sale Proceeds" set forth below in calculating the Transaction Fee, together with reasonable supporting documentation therefor, (ii) the amount of Sale Proceeds resulting from the transaction, and (iii) the amount of Transaction Fee to be due in connection with such Sale. On the day of closing of the applicable Sale or Refinancing, Lessee shall deliver to the City an updated version of such statement, certified as correct by an authorized officer of Lessee, together with the amount of Transaction Fee (if any) due in connection with such Sale or Refinancing.

As used in this Section 5.7, "Refinancing" shall mean any direct or indirect financing or refinancing of Lessee's leasehold interest in the Leased Premises, or any portion thereof (including any mortgage financing or refinancing, sale-leaseback, mezzanine financing, or other transaction of a similar nature), other than (i) the construction loan obtained by Lessee in connection with the initial development and construction of any improvements on the Leased Premises, (ii) [the first refinancing of the construction debt obtained by Lessee in connection with the initial development and construction of any improvements on the Leased Premises, (iii)] any financing received from the direct or indirect holder of any equity interests in Lessee or an Affiliate, such as a member or partner loan, provided that such loan does not constitute a permitted leasehold mortgage, (iv) equipment and other purchase money financing, (v) any loans or financing transactions, other than a sale-leaseback, to the extent the proceeds thereof are not used to repay all or any portions of the outstanding balance of a prior direct or indirect financing of Lessee's leasehold interest in the Leased Premises, or any portion thereof, and (vi) any financing obtained by a purchaser of the leasehold interest in the Leased Premises to finance such purchase.

As used in this Section 5.7, "Refinancing Proceeds" shall mean the gross proceeds of a Refinancing.

As used in this Section 5.7, "Sale" shall mean shall mean any direct or indirect, voluntary or involuntary (i) sale, transfer or assignment including sales, assignments and transfers by operation of law, by merger, or consolidation, or otherwise (any of the foregoing a "Transfer") by Lessee of all or any portion of Lessee's leasehold interest in the Leased Premises, including an assignment of this Lease; (ii) the acquisition by a direct or indirect

owner of an equity interest in Lessee (or its Affiliate) of more than fifty percent (50%) of the equity interests in Lessee; (iii) any transfer of equity interests in Lessee which, when taken together with all Transfers of equity interest in Lessee between such parties or their Affiliates, aggregates to a Transfer of more than fifty percent (50%) of the equity interests in Lessee, or otherwise results in a change in control of Lessee; (iv) in the case of a Transfer of any indirect ownership of any equity interests in Lessee, any such Transfer which, when taken together with all Transfers of indirect ownership of any equity interests in Lessee between such parties or their Affiliates aggregates to a Transfer of indirect ownership of more than fifty percent (50%) of the equity interest in Lessee, or otherwise results in a change of control of either Lessee or such indirect owner of more than fifty percent (50%) of the equity interest in Lessee; and (v) in the case of a Transfer of either direct or indirect ownership of not more than fifty percent (50%) of the equity interest in Lessee by any one Person, the Transfer of all or a portion of such ownership as part of a series of related transactions with other direct or indirect owners of an equity interest in Lessee such that the cumulative effect of such related transactions is to Transfer to a Person or its Affiliates ownership (whether direct or indirect) of more than fifty percent (50%) of the equity interest in Lessee or control of either Lessee or such indirect owners of more than fifty percent (50%) of the equity interests in Lessee.

As used in this Section 5.7, "Sale Proceeds" shall mean the gross proceeds of a Sale less (x) the gross price paid by the owner which is selling Lessee's leasehold interest in the Leased Premises or such portion thereof or such equity interest (direct or indirect) in Lessee, as the case may be, which is the subject of the Sale for which Sale Proceeds are being determined, to acquire the same, whether in the form of cash or in the form of the assumption of then-outstanding indebtedness encumbering Lessee's leasehold interest in the Leased Premises or such portion thereof or such equity interest (direct or indirect) in Lessee (as the case may be) so purchased, (y) any prepayment penalties, yield maintenance premiums or other similar amounts required to be paid by Lessee to the holder of the debt which is to be repaid with the proceeds of such pending Sale by reason of the prepayment of such debt prior to its stated maturity, and (z) the reasonable and actual documented customary closing costs paid to third parties which are not an Affiliate of Lessee in connection with such Sale (including any transfer taxes, brokerage fees or commissions, reasonable attorney's fees, and other closing costs) provided that the reduction on account of all of the payments and costs described in this clause (z) shall not exceed, in the aggregate, two percent (2%) of the gross proceeds of such Sale. With respect to the first Sale of Lessee's leasehold interest in the Leased Premises or a portion thereof or an equity interest (direct or indirect) in Lessee (as the case may be), there shall be substituted for the amount described in the foregoing clause (x) the greater of either (i) the fair market value of Lessee's leasehold interest in the Leased Premises or such portion thereof or such equity interest (direct or indirect) in Lessee (as the case may be), based on an appraisal of the fair market value of Lessee's leasehold interest in the Leased Premises satisfactory to the City, a copy of which appraisal has been provided by Lessee to the City, or (ii) the approved development costs of any improvements on the Leased Premises. In the case of a Sale of less than the entire Lessee's leasehold interest in the Leased Premises or less than the entire equity interest in Lessee, the amounts described in the foregoing clause (x) and in the immediately preceding sentence shall be calculated

on a pro rata basis to reflect the portion of such leasehold interest in the Leased Premises or such equity interest which is the subject of such Sale.

ARTICLE 6 SECURITY FOR PAYMENT

On or before the Effective Date, Lessee shall provide City with a letter of credit or surety bond ("Contract Security") in a form reasonably acceptable to the Airport Director or his or her designee in the amount of \$14,000.00. Any such letter of credit or surety bond shall (i) be issued by a bank or bonding company reasonably acceptable to City and which is authorized to do business in the State of Florida; and (ii) provide that City may draw the entire amount or any part thereof upon presentation, which presentation may be made electronically, of City's draft accompanied by a letter from the Airport Director that the Lessee has defaulted hereunder. Upon any drawing upon the Contract Security by the City, Lessee shall reinstate the stated amount of such letter of credit or surety bond within thirty (30) days to the amount required by this Article 6. At least thirty (30) days prior to the expiration of any existing letter of credit or surety bond, Lessee will renew the letter of credit or surety bond through issuance and delivery to City of either an extension of the term of the letter of credit or surety bond or a substitute letter of credit or surety bond meeting the requirements hereof and issued in the amount of \$14,000.00, and if Lessee fails to timely deliver such substitute, then City may draw the entire amount of the existing letter of credit or surety bond prior to its expiration. If the Lessee defaults or breaches any provision in this Lease Agreement, the City may draw the entire amount of the existing letter of credit or surety bond prior to its expiration.

ARTICLE 7 OBLIGATIONS OF LESSEE

Lessee shall:

(a) Conduct its operation hereunder in a safe, orderly and proper manner, considering the nature of such operation so as not to unreasonably annoy, disturb, endanger or be offensive to others at the Airport.

(b) Control, within reason, the conduct, demeanor and appearance of the Lessee's Parties, invitee(s), and those doing business with Lessee and, upon objection from City concerning the conduct, demeanor and appearance of any such persons, Lessee shall immediately take all reasonable steps necessary to remove the cause of objection.

(c) Remove from the Leased Premises or otherwise dispose of in a manner approved by the Airport Director all garbage, debris and other waste materials (whether solid or liquid) placed on the Leased Premises. Any such debris or waste which is temporarily stored shall be kept in covered garbage and waste receptacles with tight-fitting covers and designed to safely and properly contain whatever waste material may be placed therein. Lessee shall use extreme care when effecting removal of all such waste.

(d) Not create, commit or maintain any nuisance, waste, or damage to the Leased Premises and shall not do or permit to be done by anyone anything which may

result in the creation, commission or maintenance of such nuisance, waste or damage to the Leased Premises.

(e) Not create nor permit to be caused or created upon the Airport or the Leased Premises any obnoxious odor, smoke or noxious gases or vapors.

(f) Not damage nor permit its contractor(s), agent(s), invitee(s), employee(s), sub-contractor(s), to damage or destroy any part of the Airport. Lessee is solely responsible for any costs, replacement, or repairs for any damaged or destroyed property at the Airport that Lessee causes or permits to be damaged or destroyed at the Airport. Damage or the destruction caused by Lessee, its contractor(s), agent(s), invitee(s), employee(s), sub-contractor(s) or permitted by Lessee of the terminal areas, ramp, Taxiway areas, engine run-up areas, Runways, hangar facilities, another lessee's leasehold, and any other area or property at the Airport is a material breach of this Lease Agreement.

(g) Not do or permit to be done by anyone anything which may interfere with effectiveness or accessibility of any utility or other system, or damage any utility or other system, including, the drainage and sewage system, fire protection system, sprinkler system, alarm system, fire hydrants and hoses, if any, installed or located on the Leased Premises.

(h) Not overload any floor or paved area on the Leased Premises and shall repair any floor, including supporting members, and any paved area damaged by overloading.

(i) Not to do or permit to be done any act or thing upon or within the Leased Premises:

(i) Which will invalidate or conflict with any fire insurance policies covered the Leased Premises or any part thereof or other contiguous property; or

(ii) Which may constitute an extra-hazardous condition so as to increase the risks normally attendant upon the operations permitted by this Lease.

(j) Not keep or store flammable liquids within any covered and enclosed portion of the Leased Premises in violation of Applicable Law or in excess of Lessee's working requirements. Any such liquids having a flash point of less than 110°F shall be kept and stored in safety containers of a type approved by the Underwriters Laboratories. All flammable liquids kept or stored at the Premises must also comply with all applicable federal, state, City and local laws, ordinances, statutes, rules and regulations.

(k) To provide frequency protection within the aviation air/ground VHF frequency band and the UHF frequency band in accordance with restrictions promulgated by the Federal Aviation Administration for operations in the vicinity of the FAA facilities.

(l) Pay all property taxes, sales taxes, special assessments, ad valorem taxes, all federal, state, county, and local taxes, special assessments, and any other taxes or assessments levied or assessed against the Leased Premises or the leasehold estate on or before the date they are due. On or before March 31st of each year during the term of this Lease Agreement, the Lessee shall deliver to the Lessor official tax receipts showing the payment by Lessee of all taxes and special assessments. The Lessee shall also pay rental taxes in accordance with Florida law.

(m) Pay all of the following operating expenses for the Leased Premises on or before the date they are due to the service provider, including but not limited to: fire inspection fees, insurance, internet fees, janitorial expenses, water, wastewater, internet, trash, electricity, phone, gas, sewage, alarm, elevator maintenance, landscaping expenses, cable television, signage and permitting fees, and all fees required to be paid under the City's Code of Ordinances and the City's Unified Land Development Regulations, and any other fees required to be paid by the State of Florida, Broward County, and any other governmental entity.

(n) Pay all business tax receipts and any other fees required by the City of Fort Lauderdale, Broward County, State of Florida, and any other governmental entity for the operation of its business on or before the date that the fees are due.

(o) Comply with the City of Fort Lauderdale Airport Rules and Regulations, Florida law, the City of Fort Lauderdale Airport Security Plan, the Airport Minimum Standards, the City of Fort Lauderdale Code of Ordinances and Unified Land Development Regulations, Federal Law, and all applicable laws.

(p) Obtain all permits required for any improvements to be constructed or erected on the Leased Premises within six months of the effective date of this Lease Agreement.

ARTICLE 8 DEFAULT AND TERMINATION RIGHTS OF CITY

8.1 Events of Default. The occurrence of any of the following events shall constitute a "Default" under this Lease. In the event of the Lessee's default, the Airport Director or his or her Designee may automatically terminate this Lease Agreement after thirty (30) days' written notice of default is sent by the Airport Director or his or her designee to the Lessee and the Lessee fails to cure the default within the thirty (30) day period:

(a) Lessee's failure to (i) pay the Rent, any portion thereof, or any other sums payable by the date due, or (ii) maintain the insurance required by this Lease Agreement or pay Contract Security as required by as required by this Lease Agreement, or (iii) comply with the Airport Security Plan for the Airport as in effect from time to time;

(b) Lessee's failure to comply with or perform any terms, requirements, covenants, or conditions of this Lease Agreement and any amendments thereto.

(c) Lessee's failure to comply with the Airport Rules and Regulations.

- (d) The bankruptcy of Lessee.
- (e) Lessee is deemed a "Habitual Violator" by the Airport Director or his or her Designee in accordance with the terms of this Lease Agreement.
- (f) Lessee is convicted of a crime involving its leasehold interests in the Premises.
- (g) Lessee making an assignment for the benefit of its creditors.
- (h) A receiver or trustee being appointed for Lessee or a substantial portion of Lessee's assets.
- (i) Lessee's voluntary petitioning for relief under, or otherwise seeking the benefit of, any bankruptcy, reorganization, arrangement or insolvency law.
- (j) Lessee's vacating or abandoning the Leased Premises. If Lessee fails to keep the Premises open and occupy the premises for more than thirty (30) days, the Airport Director shall deem the Leased Premises vacated or abandoned.
- (k) Lessee's interest under this Lease being sold under execution or other legal process.
- (l) Lessee's interest under this Lease being modified or altered by any assignment or subletting that is not approved in accordance with the terms of this Lease Agreement.
- (m) Lessee assigning or transferring this Lease Agreement or its Leasehold interests or subletting the leasehold in any manner not expressly permitted by this Lease Agreement.
- (n) Any of the goods or chattels of Lessee used in, or incident to, the operation of Lessee's business in the Leased Premises being seized, sequestered, or impounded by virtue of, or under authority of, any legal proceeding.
- (o) Lessee's failure to comply with, Florida Law, Federal Law, the City's Code of Ordinances and Unified Land Development Regulations, the Broward County Code of Ordinances (if applicable), Environmental Laws, or any other Applicable Laws.
- (p) Non compliance with Section 287.133, Florida Statutes, as amended - Concerning Criminal Activity on Contracts with Public Entities.
- (q) Lessee's actions or inactions result in a lien being placed on the Leased Premises.
- (r) Lessee fails to pay the City or a Third Party any and all fees, costs, charges, property taxes, sales taxes, and other applicable taxes or costs by the due date for the Leased Premises.

8.2 Remedies. In the event of the occurrence of any of the foregoing Events of Default, the City, at its election, may exercise any one or more of the following options or remedies, the exercise of any of which shall not be deemed to preclude the exercise of any others herein listed or otherwise provided by Applicable Law at the same time or in subsequent times or actions:

(a) Terminate the Lease Agreement and evict the Lessee.

(b) Proceed to draw upon Lessee's Contract Security (if applicable).

(c) Terminate Lessee's right to possession under the Lease and re-enter and retake possession of the Leased Premises and relet or attempt to relet the Leased Premises on behalf of Lessee at such rent and under such terms and conditions as City may deem best under the circumstances for the purpose of reducing Lessee's liability. City shall not be deemed to have thereby accepted a surrender of the Leased Premises, and Lessee shall remain liable for all Rent, or other sums due under this Lease and for all damages suffered by City because of Lessee's breach of any of the covenants of the Lease.

(d) Declare this Lease to be terminated, ended and null and void, and re-enter upon and take possession of the Leased Premises, whereupon all right, title and interest of Lessee in the Leased Premises shall end.

(e) Accelerate and declare the entire remaining unpaid rent for the balance of this Lease and any other sums due and payable forthwith and may, at once, take legal action to recover and collect the same.

(f) If any policy of insurance required under this Lease shall expire and not be renewed or replaced by Lessee within five (5) days of such expiration, the City may obtain such insurance, and the cost of such insurance shall be reimbursed by Lessee to the City as Additional Rent within fifteen (15) days of Lessee's receipt of an invoice therefor.

(g) Exercise any other remedy available to the City for such Event of Default under Applicable Law, including but not limited to: eviction, and obtain compensatory damages, liquidated damages, and attorney's fees and costs from Lessee. The City reserves the right to recover any ascertainable actual damages incurred as a result of the failure of Lessee to perform in accordance with the requirements of this Agreement, or for losses sustained by City resultant from Lessee's failure to perform in accordance with the requirements of this Agreement.

8.3 Habitual Default. Notwithstanding the foregoing, in the event that the Lessee has frequently, regularly, or repetitively defaulted in the performance of or breached any of the terms, covenants, and conditions required herein to be kept and performed by the Lessee, and regardless of whether the Lessee has cured each individual condition of breach or default, the Lessee may be determined by the City to be an "habitual violator." The City may also deem Lessee as a "habitual violator" if Lessee is a Limited Liability Company, Corporation, or Partnership and one or more manager(s), partner(s), or CEOs(s) or officers of Lessee are also a manager(s), partner(s), or officer(s) of another Limited

Liability Company, Corporation or Partnership that leases another lot(s) or parcel(s) at the Fort Lauderdale Executive Airport from the City and the City deems that the other Lease Agreement pertaining to the other lot(s) or parcel(s) is in breach of a Lease Agreement. At the time that such determination is made, the City shall issue to the Lessee a written notice advising of such determination and citing the circumstances therefor. Such notice shall also advise Lessee that, notwithstanding any other provision of this Article 8, there shall be no further notice or grace periods to correct any subsequent breaches or defaults and that any subsequent breaches or defaults of whatever nature, taken with all previous breaches and defaults, shall be considered cumulative, and collectively shall constitute a condition of non-curable default and grounds for immediate termination of this Lease. In the event of any such subsequent breach or default, the City may terminate this Lease upon the giving of written notice of termination to the Lessee, such termination to be effective ten (10) days after notice is sent to the Lessee. Notice shall be deemed delivered at the time delivered by hand, if personally delivered or if sent via certified mail, five Business Days after being deposited in the mail, or on the next Business Day if timely delivered to an air courier guaranteeing overnight delivery.

8.4 Additional Provisions. No re-entry or retaking possession of the Leased Premises by City shall be construed as an election on its part to terminate this Lease unless a written notice of such intention be given to Lessee, nor shall pursuit of any remedy herein provided constitute a forfeiture or waiver of any rent or other monies due to City hereunder or of any damages accruing to City by reason of the violations of any of the terms, provision and covenants herein contained. City 's acceptance of rent or other monies following any non-monetary event of default hereunder shall not be construed as City 's waiver of such event of default. No forbearance or delay by City or any City Parties of any action upon any violation or breach of any of the terms, provisions and covenants herein contained shall be deemed or construed to constitute a waiver of the terms, provisions and covenants herein contained. Forbearance by City to enforce or waiver of one or more of the remedies herein provided upon an Event of Default shall not be deemed or construed to constitute a waiver of any other violation or default. Legal actions to recover for loss or damage that City may suffer by reason of termination of this Lease or the deficiency from any reletting as provided for above shall include the expense of repossessions or reletting and any repairs or remodeling undertaken by City following repossession. In the event City commences any proceeding to enforce this Lease or the relationship between the Parties or for nonpayment of Rent (of any nature whatsoever, in whole or in part) or additional monies due City from Lessee under this Lease, Lessee will not interpose any counterclaim of whatever nature or description in any such proceedings. In the event Lessee must, because of applicable court rules, interpose any counterclaim or other claim against City in such proceedings ("Counterclaim"), City and Lessee covenant and agree that, in addition to any other lawful remedy of City, upon motion of City, such Counterclaim shall be severed from the proceedings instituted by City and the proceedings instituted by City may proceed to final judgment in the Circuit Court or County Court (if legal proceedings are initiated in County Court) of Broward County, Florida, separately and apart from and without consolidation with or reference to the status of each Counterclaim.

In addition, if any litigation or legal action or other proceeding, including, but not limited to any and all claims, mediation, lawsuits, counterclaims, proceedings involving the FAA, appeals or bankruptcy proceedings whether at law or in equity, which: (i) arises out of, concerns, or relates to this Lease or (ii) is brought by the City for the enforcement of this Lease, or because of an alleged dispute, breach, default or misrepresentation in connection with any provisions of this agreement, the successful or prevailing party or parties shall be entitled to recover attorney's fees, paralegal fees, costs, court costs, consulting fees, witness fees, appellate attorney's fees and costs, expert fees, mediation fees, and all expenses even if not taxable as court costs, incurred in that action or proceeding, in addition to any other relief to which such party or parties may be entitled. The City and Lessee agree that if the Lessor brings an eviction proceeding to evict the Lessee for failure to comply with terms of this Lease and the parties settle such suit, the prevailing party shall be the City for purposes of awarding attorney's fees and costs.

8.5 Waiver of Jury Trial. City and Lessee knowingly, voluntarily and intentionally, waive trial by jury in any action, proceeding, or counterclaim brought by either of the Parties hereto against the other on any matters whatsoever arising out of, or in any way related to this Lease, the relationship of City and Lessee, Lessee's use or occupancy of the Leased Premises and/or building, and/or claim(s) or injury(s) or damage(s). The Lessor and Lessee further waive their rights to a jury trial on any documents executed in connection with this Agreement. If the Lessee contests its waiver of a jury trial or seeks a trial by jury, Lessee shall be required to pay the City's attorney's fees.

8.6 Force Majeure. If there shall occur, during the Term, (a) strike(s), lockout(s), or labor dispute(s); (b) the inability to obtain labor or materials or reasonable substitutes therefor; (c) acts of God, weather conditions, enemy or hostile governmental actions, civil commotion, fire, or other casualty, or other conditions beyond the control of the Party required to perform (each, an event of "Force Majeure"), and as a result of such Force Majeure, either City or Lessee is prevented from punctually performing any of its respective obligations under this Lease (except for the obligation to pay money), then such performance shall be temporarily excused for such period of time as the Force Majeure exists, but no longer. The Party seeking to excuse performance due to such event of Force Majeure shall provide written notice to the other Party of the Force Majeure event promptly following its commencement and written notice of the cessation or termination of such event of Force Majeure.

8.7 Time of the Essence. Time is of the essence of this Lease, and in case Lessee shall fail to perform the covenants or conditions on its part to be performed at the time fixed for the performance of such respective covenants or conditions by the provisions of this Lease, City may declare Lessee to be in default of this Lease.

ARTICLE 9 MAINTENANCE AND REPAIR

9.1 Lessee's Responsibilities. Lessee shall throughout the Term of this Lease assume the entire responsibility and shall relieve City from all responsibility for all repair and maintenance whatsoever of the Leased Premises, including without limitation,

improvements owned by the City and improvements owned by Lessee (owned by Lessee during the term of this Lease Agreement and subject to all other terms herein), whether such repair or maintenance be ordinary or extraordinary, structural or otherwise, and without limiting the generality hereof, shall:

(a) Keep the Leased Premises at all times in a clean and orderly condition and appearance and all Lessee's fixtures, equipment and personal property which are located in any part of the Leased Premises.

(b) Repair and maintain all building systems, including but not limited to HVAC, electrical, fire suppression system, plumbing, compressed air, landscaping, windows, pavements, equipment, lighting fixtures, furnishings, fixtures and exterior non-load bearing walls.

(c) Provide and maintain fire protection and safety equipment and all other equipment of every kind and nature required by any Applicable Law.

(d) At its sole expense keep and maintain the Leased Premises, ensure that there are no code violations on the Leased Premises by any action or inaction of the Lessee or any third party. Lessee shall keep and maintain the Leased Premises (which includes but not limited to the following) in "First Class Condition": all grounds, landscaping, pavement, buildings, furnishings, fixtures, equipment, windows, glass, interior and exterior walls, stairs, elevators, appliances, roofs, walkways, floors, and personal property. "First Class Condition" is defined herein as extremely good and highest quality condition that is free of rubbish, free of litter, free of broken windows, free of broken doors, free any foul smell, free of decay, and all parts and equipment are replaced and serviced promptly when required. Lessee shall not allow any part of the Leased Premises to become dilapidated.

(e) Keep all areas of the Leased Premises, including the apron areas, if any, in a state of good repair, to include repair of any damage to the pavement or other surface of the Leased Premises caused by weathering and/or aging, Lessee's operations, or by any oil, gasoline, grease, lubricants or other flammable liquids and substances having a corrosive or detrimental effect thereon.

(f) Be responsible for and pay for the maintenance and repair of all utility service lines that service the Leased Premises. Lessee shall pay for all costs, charges, and fees for the maintenance and repair of the Leased Premises including but not limited to: service lines for the supply of water, water charges and fees, gas service lines, gas charges and fees, fire inspection fees, electricity, insurance, internet fees, janitorial expenses, water, wastewater, electricity, phone, gas, sewage, alarm, elevator maintenance, trash, landscaping expenses, signage permitting fees, cable, internet, and telephone conduits and lines, sanitary sewers and storm sewers, and any other fees, charges, and costs required by the City's Code of Ordinances and the Unified Land Development Regulations, for any services or lines which are now or which may be subsequently located upon the Leased Premises and used by Lessee or any subtenants or assigns. Lessee must comply with all the sanitary and safety requirements designed

to protect the public in accordance with Federal Law, State Law, the City's Code of Ordinances, Broward County's Code of Ordinances and any other applicable law.

9.2 City's Rights. City shall not be liable for, or required to make, any repairs or perform any maintenance upon the Leased Premises. If Lessee fails to perform Lessee's maintenance responsibilities, City shall have the right, but not the obligation, to perform such maintenance responsibilities, provided City has first, in any situation not involving an emergency, by written notice to Lessee, afforded Lessee a period of ten (10) days within which to commence corrective action to correct the failure. All costs incurred by City in performing Lessee's maintenance responsibility, plus a twenty-five percent (25%) administrative charge, shall be paid by Lessee within ten (10) days of receipt of billing therefor.

ARTICLE 10 ALTERATIONS AND IMPROVEMENTS

10.1 Written Consent. Lessee shall make no alterations or improvements to the Leased Premises without approval from the City Commission at a public meeting evidenced by a written amendment to this Agreement executed by the City and Lessee.

10.2 Conditions. If Lessee requests permission to make improvements or alterations and permission is granted, the following conditions shall apply:

(a) Lessee shall apply for, obtain and comply with all required permits and licenses necessary and comply with Applicable Laws as well as any restrictions or conditions imposed by City with respect to such improvements; and

(b) Prior to any construction within the Premises, all contractors and subcontractors to perform work must be approved by City; and

(c) In accordance with Section 255.05, Florida Statutes, as amended, as it may be modified or amended, Lessee shall post with the City both performance and payment bonds, in an amount equal to the estimated cost of alterations or improvements, and Lessee must otherwise comply with the provisions of Section 255.05, Florida Statutes as amended. The minimum amount set forth in Florida law for the bonding requirement is currently \$200,000.00, so Lessee may request that the City waive the bonding requirement for construction costing less than \$200,000.00; and

(d) In addition to compliance with any restrictions or conditions, Lessee agrees to pay all costs and expenses necessary to design and construct City approved alterations or improvements, and to maintain at its expense the Leased Premises and any improvements, equipment, or displays within the Leased Premises in a good state of repair and preservation.

10.3 Subcontractor Contract Requirements. Lessee agrees to include the following provisions in any contracts it enters into with contractors in connection with the construction and completion of any alterations or improvements to the Leased Premises:

(a) In consideration of the sum of twenty-five dollars (\$25.00) and other good and valuable consideration, the Contractor shall indemnify and hold the City of Fort Lauderdale, its agents, officers, volunteers, elected or appointed officials, contractors, and employees harmless from and against or on account of any injuries or damages, received or sustained by any person, persons or entity arising out of or in any way connected with the operations or work to be performed on the subject property, including during any warranty period, by or in consequence of any negligence (excluding sole negligence of City), by use of any improper materials, by any intentional act, by any misconduct or recklessness, or by or on account of any other act or omission of said Contractor or its subcontractors, materialmen, or agents of any tier or their respective employees.

(b) Contractor agrees to indemnify and hold the City of Fort Lauderdale, its employees, its agents, volunteers, its elected and appointed officers and officials, and its contractors, harmless, including during any warranty period, against any claims or liability arising out of or in any way connected with the violation of any state, federal, City or local laws, ordinances, statutes, rules or regulations by Contractor, its subcontractors, agents, servants, or employees. Contractor agrees to indemnify and hold the City of Fort Lauderdale harmless from all such claims and fees, and from any and all suits and actions of every nature and description that may be brought against the City on account of any claims, fees, royalties or costs for any invention or patent, and from any and all suits and actions that may be brought against City including during any warranty period for infringement of any and all patents or patent rights claim by any person, firm or corporation.

(c) Contractor further agrees to indemnify and hold the City of Fort Lauderdale, its agents, officers, elected and appointed officials, its volunteers, and employees harmless, from and against or on account of any injuries or damages, losses, costs, expenses, received or sustained by any person, persons, or entity arising out of or in any way connected with patent construction defects.

(d) The Contractor shall indemnify and hold harmless the City of Fort Lauderdale, its elected and appointed officers, officials, volunteers, agents, assigns and employees, from and against any and all claims, demands, or causes of action whatsoever, and the resulting losses, costs, court costs, expert fees, appellate fees, expenses, attorneys' fees, including paralegal expenses, liabilities, damages, orders, judgments, or decrees, sustained by the City or any third party arising out of, by reason of, or resulting from any claim for invasion of the right of privacy; for defamation of any person, firm or corporation; for the violation or infringement of any copyright, trademark, trade name, service mark, or patent.

(e) These indemnifications shall survive the term of this Contract. In the event that any action or proceeding is brought against the City by reason of any such claim or demand, Contractor, upon written notice from City shall resist and defend such action or proceeding by legal counsel satisfactory to City.

10.4 Subcontractor Insurance Requirements. (Lessee agrees to include the following insurance provisions in any contracts it enters into with contractors in connection with the construction and completion of any Improvements to the Premises, and Lessee further agrees to provide City, prior to commencement of any Improvements, certificates of insurance evidencing the contractor's compliance with this Article:

(a) Without limiting any of the other obligations or liabilities of Contractor, Contractor shall provide, pay for, and maintain in force until all of its work to be performed under this Contract has been completed and accepted (or for such duration as is otherwise specified hereinafter), the insurance coverages set forth herein. All policies shall be endorsed to provide City with at least thirty (30) days prior written notice of any modification, cancellation, restriction or termination to the policy.

- (i) Workers' Compensation Insurance in compliance with the Workers' Compensation Law of the State of Florida and all applicable federal law.
- (ii) Employers' Liability with policy limits of One Hundred Thousand Dollars (\$100,000) per accident.
- (iii) Comprehensive General Liability with minimum limits of One Million Dollars (\$1,000,000.00) per occurrence, combined single limit for Bodily Injury Liability and Property Damage Liability. The City of Fort Lauderdale shall be named as an additional insured.
- (iv) Business Automobile Liability with minimum limits of One Million Dollars (\$1,000,000.00) per occurrence, combined single limit for Bodily Injury Liability and Property Damage Liability, and which covers owned, leased, hired and other non-owned vehicles.

10.5 Certification of Improvement Costs; As-Built Drawings. The cost of leasehold improvements, fixtures, and equipment shall be borne by Lessee, unless the City agrees in writing to pay any such costs. Upon completion of any leasehold improvements, Lessee shall furnish City with a certified statement of all approved improvement costs and that said costs have been satisfactorily paid in full, and that there are no liens or unpaid contractors or subcontracts relating to the improvements. Lessee shall deliver to City "as built" plans for all alterations, additions and improvements made by Lessee within thirty (30) days after completion of the same.

ARTICLE 11 TITLE TO IMPROVEMENTS

All improvements of whatever kind or nature, including but not limited to, all buildings, structures, and all equipment installed or erected on the Leased Premises including without limitation heating and air conditioning equipment, interior and exterior light fixtures, fencing, landscaping, paving, tie-down facilities, and all other improvements placed upon or constructed on the Leased Premises, and shall be deemed under the laws of the State of Florida, a part of the Leased Premises. The Lessee must ensure that all

improvements are free and clear of all liens. All improvements now existing and any and all improvements that maybe or are constructed shall become the property of City (owned by the City) upon the termination or expiration, of this Lease Agreement, and shall remain on the Leased Premises unless otherwise directed by the Airport Director or his her designee in his or her sole discretion. The Airport Director or his or her designee in his or her sole discretion may require Lessee to demolish any and all improvements, building(s), or structure(s) on the Leased Premises which are now existing or maybe constructed prior to the expiration or termination of the Lease Agreement.

Ownership of all personal property (that are not fixtures, structures, or buildings) shall be and remain with Lessee and may be removed from the Leased Premises upon the expiration or Termination of the Lease Agreement, only if Lessee is not then in default hereunder, and Lessee exercises care in the removal of its personal property, subject to any other additional requirements in this Lease Agreement. Lessee shall repair any damage to the Leased Premises caused by removal of its personal property at its own expense within five (5) days of the date of the damage or if City repairs the damage(s), Lessee shall reimburse the City for any damages to the Leased Premises or the Airport caused or resulting from the Lessee's removal of its personal property within ten (10) days of a written demand sent by the Airport Director to Lessee.

Any personal property installed (that are not fixtures) on the Leased Premises by any of Lessee's subtenants shall be and remain such subtenant's property and may be removed by the subtenant upon the termination of sublease only if the subtenant is not in default of this Lease Agreement and the Subtenant exercises care in the removal of its personal property, subject to any other additional requirements in this Lease Agreement. As a condition precedent to removing its personal property, the subtenant must hold harmless and indemnify the City and City Parties from all damage to the Leased Premises including buildings, other structures and Improvements, caused by the Subtenant's removal of its personal property.

ARTICLE 12 CONSTRUCTION LIENS

City's interest in the Leased Premises shall not be subjected to any construction, mechanic's, materialman's, tax, laborer's or any other lien, whether City has given its written approval for the improvements or otherwise, and Lessee shall hold harmless City, City Parties, and its interest in the Leased Premises from any such lien or purported lien. No third person shall ever be entitled to any lien, directly or indirectly on the Leased Premises. All persons contracting with the Lessee, or furnishing materials or labor to the Lessee, or its agents or employees shall be bound by this provision of the Lease Agreement. The Lessee is not an agent of Lessor and does not have the authority to confer a mechanic's lien upon the Lessor's property in accordance with Chapter 713, Florida Statutes, as amended. The Lessee shall inform the City within five (5) days of the filing or recording of a lien on the Leased Premises. Within fifteen (15) days of filing or recording of any lien on the Leased Premises, Lessee shall pay or satisfy the lien. Lessee shall present written documentation that the lien is satisfied to the Airport Director within five (5) days of City's request. The Airport Director in his or her sole discretion will

determine whether the documentation provided by Lessee is satisfactory and if it is not satisfactory, the Airport Director may request additional documentation which the Lessee must provide within five (5) days of a written request from the Airport Director.

ARTICLE 13 UTILITIES, FEES, AND CHARGES

Lessee agrees to provide for its own connections with utilities and to make separate agreements with the agencies responsible for these utilities. Lessee shall pay for all utility service supplied to the Leased Premises whether the bills or statements are in the name of Lessee or another person, entity, government, or third party and, if required by the utility agencies as a condition of continuing said services, Lessee shall install and pay for standard metering devices for the measurement of such services. Lessee shall be solely responsible for and shall pay at its own expense whether the bills or statements are in the name of Lessee or another person, entity, government or third party: all utility charges, operating, maintenance, and servicing charges for the Leased premises including but not limited to: natural gas, fire inspections, fire lines, connections, stormwater, drainage, cable, phone, refuse, internet, electricity, sewer, telecommunications and water used on the Leased Premises during the Term. Lessee understands that it is required to pay for all utilities and services and charges for the Leased Premises regardless of whether Lessee receives a bill for these services or charges and regardless of whether the Lessees' name is printed on the bill(s). Lessee further agrees that City shall have the right, without cost to Lessee, to install and maintain in, on, or across the Leased Premises sewer, water, gas, cable, internet, electric and telephone lines, electric substations, or other installations necessary to the operation of the Airport, or to service other tenants of City; provided, however, that City shall carry out such work and locate above-ground structures in a manner that does not unreasonably interfere with the Lessee's use of the Leased Premises.

ARTICLE 14 INGRESS AND EGRESS

Lessee, the Lessee Parties, and its suppliers of material and furnishers of services, shall have the right of ingress and egress to the Leased Premises via appropriate taxiways, public or private ways to be used in common with others having rights of passage, provided that City may, at its expense, from time to time, substitute other means of ingress and egress so long as an alternate adequate means of ingress and egress is available. The City may at any time temporarily or permanently close any taxiway, roadway or other area used as ingress or egress to the Leased Premises presently or hereafter used as such, so long as an alternative means of ingress and egress is made available to Lessee and so long as such closure does not prevent Lessee from using the Leased Premises as Lessee intends. The City may close any means of access or egress to the Leased Premises without providing an alternative means of ingress or egress due to a force majeure event or for a commercially reasonable period of time necessary to repair or otherwise maintain such areas and facilities (a "Total Closure"). In the event any such Total Closure is necessary, the City will provide Lessee with advance, written notice reasonable under the circumstances and use diligent efforts to coordinate any such

closure and maintenance activities with Lessee to minimize any adverse effects upon Lessee' operations. Lessee hereby releases and discharges City, City Parties, its successors and assigns, of and from any and all claims, demands or causes of action which Lessee may now or at any time hereafter have against any of the foregoing arising or alleged to arise out of the closing of any taxiway, apron, runway, street, roadway, or other areas used as such, whether within or outside the Leased Premises.

ARTICLE 15 TAXES, PERMITS, LICENSES

In addition to those obligations set forth in any other section of this Lease Agreement, Lessee shall pay at its own expense, all costs of operating its equipment and business, any and all ad valorem, sales, use or other taxes levied, assessed or charged upon or with respect to the Leased Premises or improvements or property Lessee places thereon and any assessed against the operation of the business and any ad valorem, sales, use or similar taxes levied or assessed with respect to this Lease or the Leased Premises, whether assessed at the Effective Date or thereafter imposed, regardless of whether such taxes are assessed against the Lessee or the City by the due date. Lessee shall obtain and pay all costs and charges by the due date for any business tax receipts, permits, licenses, or other authorizations required by City, Broward County, the State of Florida, Federal Law and any other applicable law in connection with the operation of its business at the Airport, and copies of all such permits, certificates and licenses shall be forwarded to City. Lessee shall keep all licenses, business tax receipts, permits, and any other authorizations required by the City, Broward County, the State of Florida, and Federal Law valid and in good standing during the term of this Agreement.

ARTICLE 16 INSURANCE

As a condition precedent to the effectiveness of this Agreement, during the term of this Agreement and during any renewal or extension term of this Agreement, the Lessee, at the Lessee's sole expense, shall provide insurance of such types and with such terms and limits as noted below. Providing proof of and maintaining adequate insurance coverage are material obligations of the Lessee. The Lessee shall provide the Lessor a certificate of insurance evidencing such coverage. The Lessee's insurance coverage shall be primary insurance for all applicable policies. The limits of coverage under each policy maintained by the Lessee shall not be interpreted as limiting the Lessee's liability and obligations under this Agreement. All insurance policies shall be from insurers authorized to write insurance policies in the State of Florida and that possess an A.M. Best rating of A-, VII or better. All insurance policies are subject to approval by the Lessor's Risk Manager.

The coverages, limits, and endorsements required herein protect the interests of the Lessor, and these coverages, limits, and endorsements may not be relied upon by the Lessee for assessing the extent or determining appropriate types and limits of coverage to protect the Lessee against any loss exposure, whether as a result of this Agreement or otherwise. The requirements contained herein, as well as the Lessor's review or

acknowledgement, are not intended to and shall not in any manner limit or qualify the liabilities and obligations assumed by the Lessee under this Agreement.

The following insurance policies and coverages are required:

Property Coverage

Coverage must be afforded in an amount not less than 100% of the replacement value of the property with a deductible of no more than \$25,000 each claim. Coverage form shall include, but not be limited to:

- All Risk Coverage including Flood and Windstorm with no coinsurance clause
- Any separate Flood and/or Windstorm deductibles are subject to approval by the Lessor

This policy shall insure the interests of the Lessor and Lessee in the property against all risk of physical loss and damage and name the Lessor as a loss payee.

All rights of subrogation shall be waived against Lessor under the property coverage policy.

The Lessee shall, at the Lessee's own expense, take all reasonable precautions to protect the Premises from damage or destruction.

Builder's Risk Coverage (Only applicable for new construction)

For buildings/structures under construction, coverage must be afforded in an amount not less than 100% of the total project cost, including soft costs, with a deductible of no more than \$25,000 each claim. Coverage form shall include, but not be limited to:

- All Risk Coverage including Flood and Windstorm with no coinsurance clause
- Storage and transport of materials, equipment, supplies of any kind whatsoever to be used on or incidental to the project
- Equipment Breakdown for cold testing of all mechanized, pressurized, or electrical equipment

This policy shall insure the interests of the Lessor, Lessee, and subcontractors in the property against all risk of physical loss and damage and name the Lessor as a loss payee. This insurance shall remain in effect until the work is completed and the property has been issued a Certificate of Occupancy (CO).

Collection of Insurance. In the event of destruction of or damage to over fifty percent (50%) of any of the Premises or the buildings or other structures covered by insurance and Lessee's election to rebuild the Premises or the buildings or other structures pursuant to the Lessee's option provided in this Lease, the funds payable pursuant to such insurance policies shall be payable to, and deposited in, a commercial national bank as trustee, located in Fort Lauderdale, Florida, selected by the Lessor, as a trust fund, and the funds shall be used for the purpose of reconstruction or repair, as the case may be,

of any of the buildings or other structures so damaged or destroyed. Such reconstruction and repair work shall be done in strict conformity with the ordinances and charter of the Lessor. Should the cost of reconstruction or repair exceed the amount of funds available from the proceeds of such insurance policy, then in such event, such funds shall be used as far as the same will permit in paying the cost of the reconstruction or repair. In the event that the cost of such reconstruction or repair work shall be less than the proceeds derived from such insurance policies, the surplus shall be unencumbered by Lessor.

Commercial General Liability

Coverage must be afforded under a Commercial General Liability policy with limits not less than:

- \$5,000,000 each occurrence and \$5,000,000 aggregate for Bodily Injury, Property Damage, and Personal and Advertising Injury
- \$5,000,000 each occurrence and \$5,000,000 aggregate for Products and Completed Operations

If Lessor requires other fixed base operator tenants at Airport to increase their policy limits for the insurance described in this subparagraph, then Lessee agrees to increase its insurance limits accordingly.

Policy must include coverage for Contractual Liability and Independent Contractors.

The Lessor and the Lessor's officers, employees, and volunteers are to be covered as additional insureds with a CG 20 26 04 13 Additional Insured – Designated Person or Organization Endorsement or similar endorsement providing equal or broader Additional Insured Coverage with respect to liability arising out of activities performed by or on behalf of the Lessee. The coverage shall contain no special limitation on the scope of protection afforded to the Lessor or the Lessor's officers, employees, and volunteers.

Pollution and Remediation Legal Liability (Hazardous Materials)

For the purpose of this section, the term "hazardous materials" includes all materials and substances that are designated or defined as hazardous by Florida or federal law or by the rules or regulations of Florida or any federal agency. If work being performed involves hazardous materials, the Lessee shall procure and maintain any or all of the following coverage, which will be specifically addressed upon review of exposure.

Lessee and Lessee's Contractor's Pollution Liability Coverage

For sudden and gradual occurrences and in an amount not less than \$1,000,000 per claim arising out of this Agreement, including but not limited to, all hazardous materials identified under the Agreement.

Aircraft Liability

Coverage must be afforded in an amount not less than \$10,000,000 per occurrence for any aircraft operations.

Business Automobile Liability

Coverage must be afforded for all Owned, Hired, Scheduled, and Non-Owned vehicles for Bodily Injury and Property Damage in an amount not less than \$1,000,000 combined single limit each accident.

If the Lessee does not own vehicles, the Lessee shall maintain coverage for Hired and Non-Owned Auto Liability, which may be satisfied by way of endorsement to the Commercial General Liability policy or separate Business Auto Liability policy.

Workers' Compensation and Employer's Liability

Coverage must be afforded per Chapter 440, Florida Statutes. Any person or entity performing work for or on behalf of the Lessor must provide Workers' Compensation insurance. Exceptions and exemptions will be allowed by the Lessor's Risk Manager, if they are in accordance with Florida Statute.

The Lessee waives, and the Lessee shall ensure that the Lessee's insurance carrier waives, all subrogation rights against the Lessor and the Lessor's officers, employees, and volunteers for all losses or damages. The Lessor requires the policy to be endorsed with WC 00 03 13 Waiver of our Right to Recover from Others or equivalent.

The Lessee must be in compliance with all applicable State and federal workers' compensation laws, including the U.S. Longshore Harbor Workers' Act and the Jones Act, if applicable.

Insurance Certificate Requirements

- a. The Lessee shall provide the Lessor with valid Certificates of Insurance (binders are unacceptable) no later than thirty (30) days prior to the start of work contemplated in this Agreement.
- b. The Lessee shall provide to the Lessor a Certificate of Insurance having a thirty (30) day notice of cancellation; ten (10) days' notice if cancellation is for nonpayment of premium.
- c. In the event that the insurer is unable to accommodate the cancellation notice requirement, it shall be the responsibility of the Lessee to provide the proper notice. Such notification will be in writing by registered mail, return receipt requested, and addressed to the certificate holder.
- d. In the event the Agreement term goes beyond the expiration date of the insurance policy, the Lessee shall provide the Lessor with an updated Certificate of Insurance no later than ten (10) days prior to the expiration of the insurance currently in effect. The Lessor reserves the right to suspend the Agreement until this requirement is met.

- e. The Certificate of Insurance shall indicate whether coverage is provided under a claims-made or occurrence form. If any coverage is provided on a claims-made form, the Certificate of Insurance must show a retroactive date, which shall be the effective date of the initial contract or prior.
- f. The Lessor shall be included as a Loss Payee on all property and builder's risk policies, where applicable.
- g. The Lessor shall be included as an Additional Insured on all liability policies, with the exception of Hangarkeeper's Liability and Workers' Compensation.
- h. The Lessor shall be granted a Waiver of Subrogation on the Lessee's Workers' Compensation insurance policy.
- i. The title of the Agreement and/or other identifying reference information must be listed on the Certificate of Insurance.

The Certificate Holder should read as follows:

City of Fort Lauderdale
c/o Executive Airport
6000 NW 21st Avenue
Fort Lauderdale, FL 33309

The Lessee has the sole responsibility for the payment of all insurance premiums and shall be fully and solely responsible for any costs or expenses as a result of a coverage deductible, co-insurance penalty, or self-insured retention; including any loss not covered because of the operation of such deductible, co-insurance penalty, self-insured retention, or coverage exclusion or limitation. Any costs for adding the Lessor as an Additional Insured shall be at the Lessee's expense.

If the Lessee's primary insurance policy/policies do not meet the minimum requirements, as set forth in this Agreement, the Lessee may provide evidence of an Umbrella/Excess insurance policy to comply with this requirement.

The Lessee's insurance coverage shall be primary insurance as applied to the Lessor and the Lessor's officers, employees, and volunteers. Any insurance or self-insurance maintained by the Lessor covering the Lessor, the Lessor's officers, employees, or volunteers shall be non-contributory.

Any exclusion or provision in the insurance maintained by the Lessee that excludes coverage for work contemplated in this Agreement shall be unacceptable and shall be considered breach of contract.

All required insurance policies must be maintained until this Agreement is terminated. Any lapse in coverage may be considered breach of contract. In addition, Lessee must provide to the Lessor confirmation of coverage renewal via an updated certificate of insurance should any policies expire prior to the expiration of this Agreement. The Lessor reserves the right to review, at any time, coverage forms and limits of Lessee's insurance policies.

The Lessee shall provide notice of any and all claims, accidents, and any other occurrences associated with this Agreement to the Lessee's insurance company or companies and the Lessor's Risk Management office, as soon as practical.

It is the Lessee's responsibility to ensure that any and all of the Lessee's independent contractors and subcontractors comply with these insurance requirements. All coverages for independent contractors and subcontractors shall be subject to all of the applicable requirements stated herein. Any and all deficiencies are the responsibility of the Lessee. The Lessor reserves the right to adjust insurance limits from time to time at its discretion with notice to Lessee.

ARTICLE 17 INDEMNIFICATION

A. (1) Lessee agrees to indemnify, hold harmless, and defend the City, and the City Parties and their respective successors and assigns, individually from and against any and all claims, liabilities, losses, demands, proceeds, charges, advances, disbursements, payments, expenses, losses, costs, fines, damages, court costs, settlements, judgments, orders, decrees, mandates, attorney fees and costs, appellate court costs court costs, expert fees, and paralegal fees and costs incurred prior to trial, at trial, on any appeal, and in any bankruptcy proceeding, mediation fees, consultant fees, expert fees, and causes of action ("Claims") of every kind and character, known or unknown, against any City and City Parties by reason of any damage to property or bodily injury (including death) incurred or sustained by any Party hereto, any agent or employee of any Party hereto, and any third or other party whomsoever, or any Governmental Authority, to the extent arising out of or incident to or resulting from or in connection with this Lease Agreement, Lessee's performance under this Lease, Lessee's use or occupancy of the Leased Premises, Lessee's acts, omissions or negligence or that of any of the Lessee Parties in, on or about the Leased Premises or upon the Airport or in conjunction with its use and occupancy or use of the Airport. This clause shall survive the expiration or termination of this Lease. Compliance with the insurance requirements as attached hereto shall not relieve Lessee of its liability or obligation to indemnify City as set forth in this Article.

(2) If the above indemnity or defense provisions or any part of the above indemnity or defense provisions are found by a judge in a court order to be limited by Sections 725.06(2)-(3) or Section 725.08, Florida Statutes, as amended, then with respect to the part so limited, Lessee agrees to the following: To the maximum extent permitted by Florida law, Lessee will indemnify, defend and hold harmless City and each City Party from any and all liabilities, damages, losses, and costs, including, but not limited to, reasonable attorneys' fees, to the extent caused by the negligence, recklessness, or intentional wrongful conduct of Lessee or any Lessee Party and except to the extent they are caused by the negligence, recklessness, or intentional wrongful conduct on the part of the City or any of the City Indemnitee; provided, however, (1) Lessee shall assume the responsibility to defend all Claims arising under this Lease. City is not hereby waiving any defense

or limitation of its liability, and all Claims against the City or any City Party shall be subject to the provisions of Section 768.28 of the Florida Statutes, as amended from time to time (which defense and/or limitation of liability Lessee may argue in its defense of any Claim).

(3) If the above indemnity or defense provisions or any part of the above indemnity or defense provisions are found by a judge in a court order to be limited by Section 725.06 (1), Florida Statutes, as amended, or any other Applicable Law, then with respect to the part so limited the monetary limitation on the extent of the indemnification shall be the greater of the (i) coverage amount of Commercial General Liability Insurance required under this Lease or (ii) \$1,000,000.00. Otherwise, the obligations of this Article 18 will not be limited by the amount of any insurance required to be obtained or maintained under this Lease.

- B.** Lessee shall indemnify and hold harmless the City of Fort Lauderdale, its elected and appointed officers, officials, volunteers, agents, assigns and employees, from and against any and all claims, demands, or causes of action whatsoever, and the resulting losses, costs, court costs, expert fees, appellate fees, expenses, attorneys' fees, including paralegal expenses, liabilities, damages, orders, judgments, or decrees, sustained by the City or any third party arising out of, by reason of, or resulting from any claim for invasion of the right of privacy; for defamation of any person, firm or corporation; for the violation or infringement of any copyright, trademark, trade name, service mark, or patent.
- C.** Lessee shall indemnify, hold harmless and defend the City and any and all City Parties from and against any liability for any claims and actions and all expenses incidental to the investigation and defense thereof, to the extent that such liability arises from or is based upon the violation of any Applicable Law by Lessee or any Lessee Party or those under its control.
- D.** The City shall give Lessee reasonable notice of any suit or claim for which indemnification will be sought under this Section. The City will allow Lessee or its insurer to compromise and defend the same to the extent of the interests of both Lessee and City, and reasonably cooperate with the defense or reasonable settlement of any such suit or claim.
- E.** This indemnification provision shall survive the expiration or termination of this Agreement for actions which occur during the term of this Agreement, whether such term expires naturally by passage of time or is terminated earlier.

ARTICLE 18 ENVIRONMENTAL REGULATIONS

18.1 Environmental Representations. Notwithstanding any other provisions of this Lease, and in addition to any and all other Lease requirements, and any other covenants and warranties of Lessee, Lessee hereby expressly warrants, guarantees, and represents to City, upon which City expressly relies that:

(a) Lessee is knowledgeable regarding any and all Environmental Laws, without limitation, which govern or which in any way apply to the direct or indirect results and impacts to the environmental and natural resources due to, or in any way resulting from, the conduct by Lessee of its operations pursuant to or upon the Leased Premises. Lessee agrees to keep informed of future changes in Environmental Laws relating to its operations on the Leased Premises.

(b) Lessee agrees to comply with all Environmental Laws applicable to its operations on the Leased Premises, and accepts full responsibility and liability for such compliance.

(c) Lessee shall, prior to commencement of any of Lessee's operations pursuant to this Lease, secure any and all permits, and properly make all necessary notifications, relating to its operations on the Leased Premises, and properly make all necessary notifications as may be required by any and all Governmental Authorities having jurisdiction over parties or the subject matter hereof.

(d) Lessee, and all Lessee Parties, have been fully and properly trained in the handling and storage of all such Hazardous Materials and other pollutants and contaminants applicable to its operations and responsibilities on the Leased Premises; and such training complies with any and all Applicable Laws.

(e) Lessee agrees that it will neither handle nor store any Hazardous Materials on the Leased Premises in excess of those required to carry out its permitted uses at the Leased Premises and that all such Hazardous Materials will be stored, used and disposed of in accordance with Applicable Law.

(f) Lessee shall provide City satisfactory documentary evidence of all such requisite legal permits and notifications as hereinabove required.

(g) Lessee agrees to cooperate with any investigation, audit or inquiry by City or any Governmental Authority regarding possible violation of any Environmental Law relating to its operations on the Leased Premises or at the Airport.

18.2 Generator of Hazardous Waste. If Lessee is deemed to be a generator of hazardous waste, as defined by Applicable Law, Lessee shall obtain an EPA identification number and the appropriate generator permit and shall comply with all Environmental Laws applicable to a generator of hazardous waste including, but not limited to, ensuring that the appropriate transportation and disposal of such materials are conducted in full compliance with Environmental Law.

18.3 Inventory List. Lessee maintain an accurate inventory list (including quantities) of all such Hazardous Materials, whether stored, disposed of or recycled, available at all times for inspection at any time on the Leased Premises by City officials and also by Fire Department Officials or regulatory personnel having jurisdiction over the Leased Premises, for implementation of proper storage, handling and disposal procedures.

18.4 Notification and Copies. Notification of all activities relating to Hazardous Materials by Lessee shall be provided on a timely basis to City or such other agencies as required by Applicable Law. Lessee agrees that a twenty-four (24) hour emergency coordinator and phone number shall be furnished to City and to such applicable Governmental Authorities in case of any spill, leak or other emergency situation involving Hazardous Materials. Designation of this emergency coordination may be required by Environmental Laws. Lessee agrees to provide City copies of all permit application materials, permits, monitoring reports, environmental response plans, and regulated materials storage and disposal plans related to the Leased Premises.

18.5 Violation.

(a) If City receives a notice from any Governmental Authority asserting a violation by Lessee of Lessee's covenants and agreements contained herein, or if City otherwise has reasonable grounds upon which to believe that such a violation has occurred, City shall have the right, but not the obligation, to contract, at Lessee's sole cost and expense, for the services of persons ("**Site Reviewers**") to enter the Leased Premises and perform environmental site assessments for the purpose of determining whether there exists any environmental condition that could result in any liability, cost or expense to City. The Site Reviewers shall perform such tests on the Leased Premises as may be necessary, in the opinion of the Site Reviewers, to conduct a prudent environmental site assessment. Lessee shall supply such information as is requested by the Site Reviewers. In the event City conducts testing due to information other than a notice of violation from a Governmental Authority, and the testing does not reveal any contamination in excess of permissible EPA tolerances, other than the contamination referenced in Article 21 of this Lease, City agrees to bear all costs association with the testing.

(b) If Lessee receives a Notice of Violation or similar enforcement action or notice of noncompliance, Lessee shall provide a copy of same to City within twenty-four (24) hours of receipt by Lessee or Lessee's agent.

**ARTICLE 19
FEDERAL STORM WATER REGULATIONS**

Lessee acknowledges that certain properties and uses of properties within the Airport or on City owned land are subject to Federal storm water regulations as set forth in 40 CFR Part 122. Lessee agrees to observe and abide by said regulations as applicable to the Leased Premises and its operations at the Airport. Lessee agrees to participate in any City-organized task force or other work group established to coordinate storm water activities at the Airport. In addition, Lessee agrees to participate in City's Environmental Compliance Program and is subject to and agrees to periodic inspections conducted by Airport staff to monitor the management, handling, storage, and disposal practices associated with any Hazardous Materials. Lessee shall be strictly liable for, and hereby expressly assumes all responsibility for all citations, fines, environmental controls and monitoring, clean-up and disposal, restoration and corrective measures resulting from or in any way connected with the improper use, handling, storage or disposal of all pollutants or contaminated materials, as same are defined by Applicable Law, by Lessee or any

Lessee Parties, suppliers of service or providers of materials, regardless of whether or not a default notice has been issued and notwithstanding any other obligations imposed upon Lessee pursuant to the terms of this Lease.

ARTICLE 20 ENVIRONMENTAL INSPECTION

20.1 Environmental Inspection at End of Lease Term. Within the last sixty (60) days of the Term or within sixty (60) days after earlier Lease termination, City shall have the right to have an environmental inspection performed to determine the status of any Hazardous Materials, including, but not limited to asbestos, PCBs, PFAS, and urea formaldehyde, and radon gas existing on the Leased Premises or whether any said substances have been generated, released, stored or deposited over, or then exist beneath or on the Leased Premises from any source.

Lessee hereby expressly agrees to indemnify and hold City and each City Party harmless from and against any and all liability for fines and physical damage to property or injury or death to persons, and this indemnity includes all costs, charges, expenses, judgments, demands, claims, court costs, appellate fees, expenses and attorney's fees, to the extent arising from or resulting out of, or in any way caused by, Lessee's failure to comply with any and all applicable Environmental Laws, and in any way resulting from pollution or exposure of Lessee or any third party to asbestos, PCBs, PFAS, PFOA, urea formaldehyde, and radon gas. Lessee understands that this indemnification is in addition to and is a supplement of Lessee's indemnification set forth in other provisions of this Lease and Lessee is in full understanding to the extent of this indemnification and hereby expressly acknowledges that it has received full and adequate consideration and that City would not execute this Lease without this indemnity. This provision of the lease shall survive termination of the Lease.

With regard to any contamination caused by Lessee, or arising by reason of Lessee's use or occupancy of the Leased Premises, Lessee shall immediately take such action as is necessary to clean up and remediate the Leased Premises at its own expense in accordance with applicable Environmental Laws. The remediation must continue until the Governmental Authorities with jurisdiction have determined that no further action is necessary; it being understood and agreed that Lessee shall be obligated to clean-up and remediate the Leased Premises to achieve such standards or clean-up levels as are reasonably required by the City for properties at the Airport. If the City is unable to lease the Leased Premises during the period of cleanup and remediation due to the environmental condition or cleanup work being performed, in addition to any other damages, Lessee shall be responsible for payment of lost rent or lost use to the City.

The firm(s) conducting the site inspection or the site cleanup work must be qualified and approved by the Airport Director or his or her Designee, and the methodology used by such firm shall be consistent with the then current engineering practices and methods required by the State of Florida or the United States government and be acceptable to City.

Lessee understands and agrees that it is strictly liable for any environmental violation or harm, or any contamination to the soil or the water table under the Leased Premises to the extent caused by Lessee or occurring by reason of Lessee's use or occupancy of the Leased Premises. Said liability shall extend beyond the term of the Lease until the Premises are retested and determined to be free of contamination.

ARTICLE 21 STORAGE TANKS

Lessee agrees that it will not have any underground or above ground storage tanks ("Tanks") on the Leased Premises unless specifically authorized in writing by City. If any tank is authorized by City, Lessee covenants and agrees that it will comply with all Applicable Laws concerning the installation, operation, maintenance and inspection of Tanks including financial responsibility and corrective action requirements.

ARTICLE 22 AMERICANS WITH DISABILITIES ACT

Lessee shall comply with the requirements of "The Americans with Disabilities Act" ("ADA") as published in Title 28, Code of Federal Regulations ("CFR"), Parts 35 and 36, and the State of Florida Accessibility Requirements Manual ("ARM"). Additionally, the Lessee shall comply with the requirements of the ADA in any design and construction on the Leased Premises.

ARTICLE 23 NONDISCRIMINATION

Lessee acknowledges that the City is required by the FAA under the terms of certain agreements between the City and the United States of America relative to the operation or maintenance of the Airport, the execution of which has been required as a condition precedent to the grant or receipt of federal funds for the development of the Airport, to include in this Lease certain required contract provisions, attached as "**Exhibit B**" hereto (the "Federal Nondiscrimination Clauses"). Lessee agrees to comply with the Federal Nondiscrimination Clauses and, where applicable, include the Federal Nondiscrimination Clauses in each of its subcontracts without limitation or alteration. Lessee further agrees to comply with any modification to or interpretation of the Federal Nondiscrimination Clauses that may from time to time be required by the FAA or other agency with jurisdiction, within thirty (30) days of receiving notice from the City of such required modifications.

ARTICLE 24 RIGHTS RESERVED TO CITY

Rights not specifically granted to Lessee by this Lease are expressly and independently reserved to City. City expressly reserves the right to prevent any use of the Leased Premises which would interfere with or adversely affect the operation or maintenance of the Airport, the authorized operations of other Airport tenants or users, or otherwise constitute an Airport hazard.

**ARTICLE 25
RIGHT OF ENTRY**

City shall have the right to enter the Leased Premises during normal business hours with no less than twenty-four (24) hours notice to Lessee (which may be oral), except in an emergency, to inspect the Leased Premises for the purpose of determining whether Lessee is in compliance with the requirements of this Lease. If, upon inspecting the Leased Premises, the City reasonably determines that the Lessee is not in compliance with this Lease, the City shall provide the Lessee with a written notice of noncompliance listing the items that are not in compliance with this Lease. If the Lessee does not initiate corrective action to cure the items in noncompliance within thirty (30) days after notice of default is sent by the Airport Director to the Lessee, the Airport Director may terminate the Lease Agreement if the Lessee fails to cure the default. City reserves the right to enter the Leased Premises at any time with or without notice in case of emergency.

**ARTICLE 26
RIGHT OF FLIGHT**

It shall be a condition of this Lease that City reserves unto itself, its successors and assigns, for the use and benefit of the public, a right of flight for the passage of aircraft in the airspace above the surface of the real property owned by City, including without limitation the Leased Premises, together with the right to cause in said airspace such noise as may be inherent in the operation of aircraft, now known or hereafter used, for navigation of or flight in the said airspace, and for use of said airspace for landing on, taking off from or operating on the Airport. Lessee further expressly agrees for itself, its successors and assigns to restrict the height of structures, objects of natural growth and other obstruction on Leased Premises to such a height so as to comply with Title 14 CFR, Part 77.

**ARTICLE 27
SUBORDINATION TO DEEDS AND GRANT AGREEMENTS**

This Lease shall be subject and subordinate to all the terms, and conditions of any instruments and documents under which City acquired the land or improvements thereon constituting the Airport or any portion thereof, of which said Leased Premises are a part, including the deed to the City from the Department of Defense, and shall be given only such effect as will not conflict with nor be inconsistent with such terms and conditions. Lessee understands and agrees that this Lease shall be subordinate to the provisions of any existing or future agreement between City and the United States of America, the State of Florida, or any of its or their agencies, relative to the operation or maintenance of the Airport, the execution of which has been or may be required as a condition precedent to the grant or receipt of federal or State funds for the development of the Airport, and to any terms or conditions imposed upon the Airport by any other Governmental Authority. In the event that this Lease, either on its own terms or by any other reason, conflicts with or violates the terms of any such deeds or agreements, City may unilaterally amend, alter, or otherwise modify the terms of this Lease in order to resolve such conflict or violation without compromising or destroying any remaining portions of this Lease, and such

remaining provisions shall remain binding and in full effect upon the parties as if no such amendment or alteration had occurred.

ARTICLE 28 SIGNS

28.1 Written Approval. Lessee shall obtain approval the City and the Airport Director and obtain all required permits in accordance the City's Code of Ordinances and the ULDR, prior to erecting or displaying any signs on the Leased Premises or any advertising at or on the exterior parts of the Leased Premises.

28.2 Removal. Upon the expiration or termination of the Lease, Lessee shall remove, obliterate or paint out, as City may direct, at its sole discretion, any and all signs and advertising on the Leased Premises and shall restore the portion of the Leased Premises affected by such signs or advertising to the same conditions as existed prior to the placement of such signs or advertising. The Airport Director may waive the aforementioned requirement in writing. In the event of failure on the part of Lessee to remove, obliterate or paint out each and every sign or advertising and to so restore the Premises, City may perform the necessary work and Lessee shall pay these costs plus a 25% administrative fee to City.

ARTICLE 29 QUIET ENJOYMENT

Subject to Lessee's compliance with each and every requirement and obligation on its part to be met under this Lease, City covenants that Lessee shall and may peaceably and quietly have, hold and enjoy the Leased Premises and all parts thereof for the Term hereby granted, subject to the terms and provisions hereof.

ARTICLE 30 NO MORTGAGE RIGHTS OF LESSEE

30.1 Lessee shall not mortgage, pledge, or hypothecate its leasehold interest under this Lease without the prior written consent of the Airport Director. As a condition precedent to obtaining the consent of the Airport Director, Lessee and its lender shall provide to City written evidence that the priority rights of City under this Lease will not be adversely affected by such action. In addition, any leasehold mortgage, leasehold deed of trust or other security financing arrangement shall specifically acknowledge that such financing shall never be construed to pledge, mortgage, encumber, hypothecate, alienate or otherwise grant or convey all or any part of the fee simple title to the real property underlying the leasehold estate herein given, or leasehold improvements which are the property of the City, as the same is publicly-owned property not subject to encumbrance or involuntary sale or divestiture. In the event that the Lessee mortgages its leasehold interest, the Mortgagee shall send via certified mail return receipt requested to the City (in accordance with the notice requirements in this Lease Agreement, with a copy to all the persons listed in the Notice Provision of this Lease Agreement) the following two documents within five (5) days after the date that the mortgage is recorded in the Official

Records of Broward County or any other County: 1) Written notice of the name and address of the leasehold Mortgagee; and 2) A certified copy of the mortgage recorded in the Official Records of Broward County or any other County. The City shall not provide any notice to the Leasehold Mortgagee (including any notice of default) if the City does not receive both written notice of the mortgagee's name and address and a certified copy of the mortgage within five (5) days after the date that the mortgage is recorded.

30.2 *If City the Authorizes the Tenant to obtain a Leasehold Mortgage.* Notwithstanding the prohibition upon the placement or creation of liens set forth in this Lease, including any leasehold interests created hereunder in the Leased Premises, the Lessee may, upon prior written permission of the Airport Director, pledge the Lessee's leasehold interest created hereunder pursuant to a mortgage, deed of trust, security deed, or other security instrument encumbering the leasehold estate created by this Lease (a "Leasehold Mortgage"), provided that such pledge is made in connection with the financing or refinancing (a "Loan") of amounts to be used solely for the construction of any improvements on the Leased Premises referenced herein or other improvements to the Leased Premises and shall be subject, subordinate, and inferior at all times to the rights of the City under this Lease. Approval of a Leasehold Mortgage may be given by the City only if, at a minimum, the following conditions are satisfied:

- (a) The documents which are to be used to finance and secure the proposed transaction (i.e. the obtaining of funds and placing of a leasehold mortgage) are submitted to the City for review and approval prior to their execution by the putative lender (the "Lender") and the Lessee (the "Proposed Financing Documents");
- (b) The funds obtained via the transaction contemplated under the Proposed Financing Documents are to be used solely for the construction of any improvements on the Leased Premises approved by the City, or refinancing any Loan for such purposes;
- (c) The entity providing the Loan shall be a financial institution regularly engaged in the business of making mortgage loans secured by commercial properties, with a net worth of not less than twenty million dollars (\$20,000,000) which is not an affiliate of Lessee (a "Lender");
- (d) The Lender must certify to the City that it has reviewed this Lease and accepted provisions that may affect the Leasehold Mortgagee and that no loan requirements conflict with or materially diminish any provisions of this Lease;
- (e) The Proposed Financing Documents include the following terms:
 - (i) The encumbrances under the Proposed Financing Documents shall be subordinate to the City's interests under this Lease;
 - (ii) The term of any such Loan shall not exceed the Term of this Lease (excluding any extensions);

- (iii) Upon any default by the Lessee under the note, mortgage, or any of the other Proposed Financing Documents (a "Financing Default"), the City shall have a lien with first priority on all Lessee-owned property at the Leased Premises;
- (iv) The Lender agrees to provide and maintain current contact information with the City and provide the City with concurrent copies of any notices or communications regarding a Financing Default;
- (v) The City shall be notified at least seven (7) days prior to the Lender exercising its rights under the Leasehold Mortgage to take possession or control of the Lessee's business or the Leased Premises or any portion thereof;
- (vi) The Lender explicitly agrees that the Leased Premises and any improvements made thereupon must be used solely for the permitted uses set forth in this Lease and no others, and any change in use may occur only upon prior written permission of the City, which the City may grant or deny in its sole discretion;
- (vii) The Leasehold Mortgage may secure only Lessee's obligations with respect to a Loan that will be applied to finance or refinance improvements to the Leased Premises and may not cross collateralize or secure any other loans or obligations of Lessee;
- (viii) In the event that the Lender exercises its security interest in the Leasehold Mortgage to take possession or control of the Lessee's business, the Leased Premises, or any part thereof, the Lender is limited to a total period of twelve (12) months to locate a replacement tenant that is acceptable to the City, in its reasonable discretion. In the event that a tenant acceptable to the City is not obtained within the above-referenced twelve (12) month period, then the Leasehold Mortgage shall terminate and all of the Lender's rights in this Lease, the Improvements constructed upon the Leased Premises, or any part thereof shall be extinguished;
- (ix) The Lender agrees to hold the City and City Parties harmless for any damages the Lender may incur as a result of any action or inaction in connection with the exercise of the City's rights under this provision of the Lease or the related Proposed Financing Documents, including, without limitation the Leasehold Mortgage; and
- (x) Any Financing Default relating to the encumbrances under the Proposed Financing Documents shall be a default of this Lease.

30.3 Failure to Comply. If the Lender or other lienholder fails to comply with any of the foregoing requirements, such failure shall be an Event of Default under this Lease and

the City may at any time (but is not required to) terminate this Lease and exercise any rights the City may have under this Lease for an Event of Default.

30.4 No Additional Leasehold Mortgages. Lessee may enter into and encumber the Leased Premises with only one Leasehold Mortgage in accordance with this Article at any time.

30.5 Lender's Right to Cure. If Lessee enters into a Leasehold Mortgage in accordance with this Article, and if the Lender/Mortgagee has provided the City with notice of the name and address of the Leasehold mortgagee and a certified copy of the mortgage within five (5) days of the date that the mortgage is recorded in accordance with the requirements written in paragraph 30.1 above, then all notices of default given under this Lease to the Lessee shall also be sent to the Lender/Mortgagee at the address provided by the Mortgagee/Lender to the City. Any notice properly mailed to Mortgagee/Lender by registered mail, postage and fees prepaid, shall be deemed delivered when mailed, whether received or not. The Lender shall have the right to remedy any default under this Lease or cause the same to be remedied and the City shall accept such performance by or at the direction of such Lender/Mortgagee as if the same had been made by the Lessee. In case of a default, the City shall not be permitted to terminate this Lease by reason of the occurrence of such default only if the following requirements are met:

- i) If the Lender, within thirty (30) days after the giving of notice of such default, commences foreclosure or similar proceedings under the Leasehold Mortgage for the purpose of acquiring the Lessee's interest in this Lease and thereafter the foreclosure proceedings are concluded within 240 days after the City sends notice of Default to the Mortgagee.
- ii) The Mortgagee must bring current all payments of Rent payable by the Lessee hereunder and cure any other breach or default of the Lease Agreement within thirty days after the notice of default is sent to Mortgagee.
- iii) The Lender/Mortgagee may become the legal owner and holder of the leasehold estate under this Lease by foreclosure of its Leasehold Mortgage or as a result of the assignment of this Lease in lieu of foreclosure.

30.6 Notwithstanding any term or provision of any Leasehold Mortgage or this Lease to the contrary, under no circumstances shall any such Leasehold Mortgage or Loan constitute an indebtedness or obligation of the City nor shall the City be liable in any way for the payment of any portion of the indebtedness evidenced by such Leasehold Mortgage or for the payment or performance of any obligation thereunder or secured thereby. Nothing in this Lease shall operate as a pledge of the City's credit within the meaning of any constitutional or statutory debt limitation.]

**ARTICLE 31
RENT A SEPARATE COVENANT**

Lessee shall not for any reason withhold or reduce Lessee's required payments of Rent and other charges provided in this Lease, it being expressly understood and agreed by the Parties that the payment of Rent and any other rents, fees or charges provided hereunder is a covenant by Lessee that is independent of the other covenants of the Parties hereunder.

**ARTICLE 32
ASSIGNMENT**

Lessee shall not sublease, sublet, transfer, convey, pledge or assign, directly or indirectly, this Lease, either in whole or in part, without prior written consent of City. Written consent to an assignment or sublease must be obtained by approval of the City Commission at a public meeting. The Written Consent must be done with the approval and full execution of a Consent to Assignment of Lease Agreement by the City, Assignor, and Assignee or approval and full execution of a Consent to Sublease of Lease Agreement. The Airport Director in his or her sole discretion may require that any assignee or subtenant meet certain objective financial worth and operational standards. Any assignment or sublease without the written consent of the City shall be void *ab initio* and of no force or effect. No request for, or consent to, such assignment shall be considered unless Lessee has paid all rent, fees, costs, and charges required by this Lease Agreement and Lessee has complied with all provisions in this Lease Agreement, including but not limited to construction or improvement deadlines, if applicable. The City Commission and the Airport Director or his or her designee reserves the right to investigate the financial capacity of the proposed assignee prior to making its decision, and **LESSEE SHALL REMAIN LIABLE FOR ALL OBLIGATIONS UNDER THIS LEASE AFTER SUCH ASSIGNMENT OR SUBLEASE.** If the City's consent to a sublease is given, Lessee shall comply with the provisions of Article 5 regarding calculation and payment of Transaction Rent. Lessee shall provide City a copy of the proposed sublease agreement prior to any request for consent. All subleases shall be limited to a term of one (1) year unless otherwise agreed to in writing by City. All sublessees and assignees must comply with all the terms of this Lease Agreement and are liable for all obligations, costs, charges, fees, and requirements provided by this Lease Agreement regardless of whether the obligations, liabilities, charges, fees, or costs, occurred prior to the approval of the assignment or sublease or prior to the full execution of the Consent to Assignment of Lease Agreement or Consent to Assignment of Sublease.

If there shall occur any change in the ownership of and/or power to vote the majority of the outstanding capital stock or membership interest of Lessee, whether such change or ownership is by sale, assignment, bequest, inheritance, operation of law or otherwise, Lessee shall have an affirmative obligation to notify the City within five (5) calendar days of any such change. The City reserves the right to require a written amendment to this Lease to effectuate any such change in ownership or corporate structure.

**ARTICLE 33
CORPORATE TENANCY**

If Lessee is a corporation or limited liability company, the undersigned officer of Lessee hereby warrants and certifies to City that Lessee is a corporation or limited liability company in good standing and is authorized to do business in the State of Florida and shall provide proof of good standing to City. The undersigned officer of Lessee hereby further warrants and certifies to City that he or she, as such officer, is authorized and empowered to bind the entity to the terms of this Lease by his or her signature thereto and that the Lessee and its officers, directors, shareholders, members and affiliates are not in violation of Sections 287.133 and 287.134, Florida Statutes, as amended. Upon execution hereof, Lessee shall provide to the City a letter, advising City of all persons or entities owning 5% or more of the voting interest of the corporation or limited liability corporation. Failure of Lessee to maintain an active status with the Florida Division of Corporations, shall constitute a breach of this Lease Agreement.

**ARTICLE 34
EMINENT DOMAIN AND DAMAGE TO LEASED PREMISES**

34.1 Damage to, Destruction or Condemnation of Airport.

In the event any Governmental Authority shall, by exercise of the right of eminent domain or any other power, acquire title in whole or in part of the Airport, including any portion assigned to Lessee, Lessee shall have no right of recovery whatsoever against City but shall make its claim for compensation solely against such Governmental Authority.

34.2 Damage or Destruction of Leased Premises. If the Leased Premises shall be partially damaged by fire or other casualty, but not rendered untenable, the Leased Premises shall be repaired within thirty (30) days by the Lessee at its own cost and expense, and the Rent payable hereunder with respect to the Leased Premises shall continue to be paid. If the damage shall be so extensive as to render such Leased Premises untenable but capable of being repaired, Lessee shall repair the Leased Premises within ninety (90) days, at its own cost and expense, and the Rent payable hereunder with respect to the Leased Premises shall continue to be paid.

34.3 Untenantable Conditions.

In case any buildings and structures on the Leased Premises are completely destroyed by fire or other casualty or so damaged that it will remain untenable for more than ninety (90) days, or in case it does so remain untenable for more than ninety (90) days, Lessee shall repair or reconstruct the buildings and structures on the Leased with due diligence at its own cost and expense. Lessee shall continue to pay Rent and all charges and costs required by this Lease Agreement to the City.

**ARTICLE 35
NO ACCEPTANCE OF SURRENDER**

No act or thing done by City or any City Party during the term of this Lease shall be deemed an acceptance of the surrender of this Lease and no acceptance of a surrender shall be valid unless in writing.

**ARTICLE 36
PERSONAL PROPERTY**

Any personal property of Lessee or of others placed in the Leased Premises shall be at the sole risk of Lessee or the owners thereof, and City shall not be liable for any loss or damage thereto, irrespective of the cause of such loss or damage, and Lessee hereby waives all rights of subrogation or recovery from City for such damage, destruction or loss.

**ARTICLE 37
APPLICABLE LAW AND VENUE**

Notwithstanding any other provision of any Applicable Laws, this Lease shall be construed in accordance with the laws of the State of Florida. Venue for any action brought pursuant to this Lease shall be solely in Broward County, Florida. Any action for breach of or enforcement of any provision of this Lease shall be brought in a court of appropriate jurisdiction in and for Broward County, Florida.

**ARTICLE 38
SIGNATORY AUTHORITY**

Lessee shall provide City with copies of requisite documentation evidencing that the signator for Lessee has the authority to enter into this Agreement. The documentation required includes but is not limited to corporate resolutions and corporate agreements.

**ARTICLE 39
SEVERABILITY**

The invalidity of any portion, article, paragraph, provision or clause of this Lease shall have no effect upon the validity of any other part of portion thereof.

**ARTICLE 40
NOTICES AND COMMUNICATIONS**

All notices or other communications to City or to Lessee shall be done in writing and sent by certified mail, return receipt requested, or by delivery in person or by a nationally recognized courier or overnight delivery service, and fees must be pre-paid. All notice shall be deemed validly given, served, or delivered, on the date that it is delivered or the date or it is received or refused. The following persons must be sent notice and any other communications in accordance with the terms of this Lease Agreement:

To City:
Rufus James, Airport Director
City of Fort Lauderdale
6000 N.W. 21st Avenue
Fort Lauderdale, FL 33309

To Lessee:
MNREH FLORIDA, LLC, a Florida limited
liability company, whose principal address
is 84 Isla Bahia Drive, Fort Lauderdale,
Florida 33316

With Copy to the:
City Manager
City of Fort Lauderdale
100 North Andrews Avenue
Fort Lauderdale, Florida 33301-1016

With a Copy to the:
City Attorney
City of Fort Lauderdale
100 North Andrews Avenue
Fort Lauderdale, Florida 33301-1016

With a Copy to the:
City Clerk
City of Fort Lauderdale
100 North Andrews Avenue
Fort Lauderdale, Florida 33301-1016

The City and Lessee may change the persons and addresses above in writing by notice to the other Party delivered in accordance with the provisions of this Article. The notice to any leasehold mortgagee, and any other person, will only be provided if such mortgagee has complied with the provisions of this Lease Agreement.

ARTICLE 41 SUBORDINATION TO BOND RESOLUTION

This Lease and all rights of Lessee hereunder are expressly subordinated and subject to the lien and provisions of any pledge, transfer, hypothecation, or assignment made (at any time) by City to secure Bond financing. This Lease is subject and subordinate to the terms, covenants, and conditions of any Bond Resolution heretofore or hereafter adopted by the City that authorizes the issuance of Bonds by City. City may amend or modify the Bond Resolution or make any change thereto. Conflicts between this Lease and the Bond Resolution shall be resolved in favor of the Bond Resolution.

ARTICLE 42 FEDERAL RIGHT TO RECLAIM

In the event a United States governmental agency shall demand and take over the entire facilities of the Airport or the portion thereof wherein the Leased Premises are located, for public purposes, then this Lease shall hereupon terminate and City shall be released and fully discharged from any and all liability hereunder. In the event of such termination,

Lessee's obligation to pay Rent shall cease; however, nothing herein shall be construed as relieving Lessee from any of its liabilities relating to events or claims of any kind whatsoever prior to such termination under this Article.

ARTICLE 43 RELATIONSHIP OF THE PARTIES

Lessee is and shall be deemed to be an independent contractor and operator responsible to all parties for its respective acts or omissions, and City shall in no way be responsible for such acts or omissions nor shall the City and Lessee be considered as joint venturers. Nothing in this Lease is intended to create any third-party beneficiaries hereto.

ARTICLE 44 RADON GAS

Radon is a naturally occurring radioactive gas that, when it has accumulated in a building in sufficient quantities, may present health risk to persons who are exposed to it over a period of time. Levels of radon that exceed federal and state guidelines have been found in buildings in Florida. Additional information regarding radon and radon testing may be obtained from your county public health unit.

ARTICLE 45 COMPLIANCE WITH CHAPTER 119, FLORIDA STATUTES, PUBLIC RECORDS LAW

IF THE LESSEE HAS QUESTIONS REGARDING THE APPLICATION OF CHAPTER 119, FLORIDA STATUTES, TO THE LESSEE'S DUTY TO PROVIDE PUBLIC RECORDS RELATING TO THIS LEASE, CONTACT THE CUSTODIAN OF PUBLIC RECORDS AT CITY CLERK'S OFFICE 100 NORTH ANDREWS AVENUE, FORT LAUDERDALE, FLORIDA 33301, PHONE: 954-828-5010, EMAIL: PRRCONTRACT@FORTLAUDERDALE.GOV.

The Lessee shall comply with public records laws, specifically the Lessee shall:

- (a) Keep and maintain public records required by the City in order to perform the services in this Lease.
- (b) Upon request from the City custodian of public records, provide the City with a copy of the requested records or allow the records to be inspected or copied within a reasonable time at a cost that does not exceed the cost provided in Chapter 119, Fla. Stat. or as otherwise provided by Law.
- (c) Ensure that public records that are exempt or confidential and exempt from public records disclosure requirements are not disclosed except as authorized by law for the duration of the Term of this Lease and following completion of the Term of this Lease.

- (d) Upon completion of the Term of this Lease, keep and maintain public records required by the City to perform the services. The Lessee shall meet all applicable requirements for retaining public records. All records stored electronically must be provided to the City, upon request from the City custodian of public records, in a format that is compatible with the information technology systems of the City.

ARTICLE 46 CONFIDENTIAL INFORMATION

Simultaneously with providing any records to the City, Lessee shall identify any such records that Lessee claims are confidential or trade secrets ("Confidential Information") under Florida law. In the event the City receives any public records request for such Confidential Information, the City shall notify Lessee and allow Lessee a reasonable opportunity, consistent with Applicable Laws, to seek judicial relief prior to disclosing any such Confidential Information. If Lessee fails to identify any such records as Confidential Information when they are initially provided to the City and fails to obtain judicial relief (if required by Florida law or any other applicable law), the City may disclose such records pursuant to a public records request without notice to Lessee.

ARTICLE 47 NO INDIVIDUAL LIABILITY

City and Lessee agree that no City Commissioner, City Party, elected or appointed official, officer, contractor, volunteer, agent or employee of the City shall be personally liable, charged personally or held contractually liable under any term or provision of this Agreement or of any supplement, amendment, or modification to this Agreement or because of any breach thereof, or because of its or their execution or attempted execution.

ARTICLE 48 MISCELLANEOUS

All of the terms and provisions hereof shall be binding upon and the benefits inure to the Parties hereto and their heirs, personal representatives, successors and assigns. This Lease, and instruments or documents relating to same, shall be construed under Florida law. This Lease represents the complete Lease between the Parties and any prior agreements or representations, whether written or verbal, are hereby superseded. This Lease may subsequently be amended only by written instrument signed by the City and Lessee and approved by the City Commission at a public meeting.

ARTICLE 49 ESTOPPEL CERTIFICATES

An estoppel certificate may be provided by or on behalf of the City as a courtesy, but is not required. An estoppel certificate/letter issued by or on behalf of the City does not constitute a waiver of any rights the City has under this Lease, nor provide Lessee with any rights, privileges, warranties, or covenants not contained in this Lease. An estoppel certificate/letter issued by or on behalf of the City does not amend or modify this Lease

and does not release or change the Lessee's obligations under this Lease. Regardless of any statements or information provided in an estoppel certificate/letter, Lessee is obligated to comply with all the terms and conditions in this Lease, including but not limited to the payment of all fees, costs, and Rent. An estoppel certificate/letter issued by or on behalf of the City is subject to the City's unlimited review and may be revised or withdrawn accordingly by the City at any time. Failure of the City to provide an estoppel certificate/letter is not a breach of this Lease.

ARTICLE 50 RECORDING

Lessee shall record at its own expense this Lease Agreement, any and all amendments to the Lease Agreement, any and all assignments of the Lease Agreement, any and all of the City's consents to the Assignment of the Lease Agreement, and any and all of the City's consents to subletting the leasehold, in the Broward County Public Records within five (5) days of the full execution of any of the aforementioned documents by all the parties. Lessee must provide copies of all of the following documents (which must be fully executed and recorded) within five (5) days of recording the document(s) to the City Clerk and the Airport Director: 1) The Lease Agreement, and 2) Any and all assignments to the Lease Agreement, 3) Any and all amendments to Lease Agreement, and 4) Any and all consents from the City to the Assignment of the Lease Agreement, and 5) Any and all consents from the City to Subletting the Leasehold.

ARTICLE 51 SOVEREIGN IMMUNITY

Nothing contained herein is intended nor shall be construed to waive City's rights to Sovereign Immunity under the common law or Section 768.28, Florida Statutes, as may be amended from time to time.

ARTICLE 52 PROHIBITION AGAINST CONTRACTING WITH SCRUTINIZED COMPANIES

Prohibition Against Contracting With Scrutinized Companies: Subject to *Odebrecht Construction, Inc., v. Prasad*, 876 F.Supp.2d 1305 (S.D. Fla. 2012), affirmed, *Odebrecht Construction, Inc., v. Secretary, Florida Department of Transportation*, 715 F.3d 1268 (11th Cir. 2013), with regard to the "Cuba Amendment," the Contractor certifies that it is not on the Scrutinized Companies with Activities in Sudan List or the Scrutinized Companies with Activities in the Iran Petroleum Energy Sector List, and that it does not have business operations in Cuba or Syria, as provided in Section 287.135, Florida Statutes (2022), as may be amended or revised. The Lessee certifies that it is not on the Scrutinized Companies that Boycott Israel List created pursuant to Section 215.4725, Florida Statutes (2022), as may be amended or revised, and that it is not engaged in a boycott of Israel. The City may terminate this Agreement at the City's option if the Lessee is found to have submitted a false certification as provided under subsection (5) of Section 287.135, Florida Statutes (2022), as may be amended or revised, or been placed on the Scrutinized Companies with Activities in Sudan List or the Scrutinized Companies with

Activities in the Iran Petroleum Energy Sector List or the Scrutinized Companies that Boycott Israel List created pursuant to Section 215.4725, Florida Statutes (2022), as may be amended or revised, or is engaged in a boycott of Israel or has been engaged in business operations in Cuba or Syria, as defined in Section 287.135, Florida Statutes (2022), as may be amended or revised.

ARTICLE 53 PUBLIC ENTITY CRIMES

Public Entity Crimes: In accordance with the Public Crimes Act, Section 287.133, Florida Statutes (2022), as may be amended or revised, a person or affiliate who is a contractor, consultant or other provider, who has been placed on the convicted vendor list following a conviction for a public entity crime may not submit a bid on a contract to provide any goods or services to the City, may not submit a bid on a contract with the City for the construction or repair of a public building or public work, may not submit bids on leases of real property to the City, may not be awarded or perform work as a contractor, supplier, subcontractor, or consultant under a contract with the City, and may not transact any business with the City in excess of the threshold amount provided in Section 287.017, Florida Statutes (2022), as may be amended or revised, for category two purchases for a period of thirty-six (36) months from the date of being placed on the convicted vendor list. Violation of this section by Contractor shall result in cancellation of the City purchase and may result in Contractor debarment.

ARTICLE 54 INDEPENDENT

The Lessee, its contractor(s), its employees, volunteers and agents shall be and remain independent and are not agents or employees of the City with respect to all of the acts and services performed by and under the terms of this Agreement. This Agreement shall not in any way be constructed to create a partnership, association or any other kind of joint undertaking or venture between the Parties

ARTICLE 55 INDEMNITY FOR CONTRACTORS

Lessee hereby indemnifies the City and City Parties from any claim of lien by any contractor, sub-contractor, materialman or any other Person, firm or corporation whatsoever, and Lessee further agrees to hold City and City Parties harmless and to indemnify the Lessor for all costs, including costs of defenses, attorney's fees and other expenses, in connection with any claim of whatsoever kind, or arising out of the construction of any Improvements or the making of any alterations to the Leased Premises.

ARTICLE 56 COMPLIANCE WITH LAWS AND REGULATIONS OF GOVERNMENTAL AGENCIES

Lessee shall comply with the laws of all governmental agencies. Lessee shall specifically comply with all federal, state, and local laws, ordinances, resolutions and statutes

including but not limited to: Florida Law, Federal Law, the City of Fort Lauderdale Code of Ordinances and Unified Land Development Regulations, Broward County Code of Ordinances, City Resolutions, City Rules, City Standards and Regulations, Minimum Standards, and any other governmental entity or agency that has jurisdiction over Lessee and the Leased Premises.

**ARTICLE 57
CONTINUED PERFORMANCE AFTER DEFAULT**

Continued performance by either party pursuant to the terms of this Lease Agreement after default of any of the terms, covenants and conditions, shall not be deemed a waiver of any right to terminate this Lease Agreement and obtain any damages or relief that the party may obtain in accordance with this Agreement and Florida Law for any default, and no waiver of such default shall be construed to operate as a waiver of any default.

**ARTICLE 58
MINIMUM STANDARDS**

In addition to the covenants and agreements contained in this Agreement, this Lease is further subject to the provisions of those certain Minimum Standards pertaining to airport tenants as adopted by City of Fort Lauderdale Resolution No. 05-29, as such Minimum Standards are amended from time to time. Lessee agrees to comply with the Airport's Minimum Standards.

**ARTICLE 59
STORMWATER MANAGEMENT PROGRAM**

Lessee acknowledges that the City of Fort Lauderdale has adopted a stormwater management program that imposes a stormwater management utility fee upon every lot and parcel within the City of Fort Lauderdale for services and facilities provided by the stormwater management program. Lessee specifically agrees that any such fee imposed on the Premises shall be paid timely and in whole solely by Lessee.

**ARTICLE 60
POLICE POWERS**

City cannot, and hereby specifically does not, waive or relinquish any of its regulatory approval or enforcement rights and obligations as it may relate to regulations governing the Premises, any Improvements thereon, or any operations at the Premises. Nothing in this Lease shall be deemed to create an affirmative duty of City to abrogate its sovereign right to exercise its police powers and governmental powers by approving or disapproving or taking any other action in accordance with its zoning and land use codes, administrative codes, ordinances, rules and regulations, federal laws and regulations, state laws and regulations, and grant agreements. In addition, nothing herein shall be considered "zoning by contract."

Certain provisions of this Lease may require the City and/or its boards, departments or agencies, acting in their governmental capacity, to consider certain changes in the City's

Comprehensive Land Use Master Plan and/or Unified Land Development Regulations or take other governmental actions. All such considerations and actions shall be undertaken in accordance with established requirements of state statute, and the City of Fort Lauderdale Charter and City of Fort Lauderdale ordinances, in the exercise of the City's jurisdiction under its police power. Nothing in this Agreement is intended to limit or restrict the powers and responsibilities of the City in acting on such applications by virtue of the fact that the City may have consent to such applications as a property owner.

ARTICLE 61 AIRPORT SECURITY PLAN/PROGRAM

(a) Lessee agrees to observe all security requirements and other requirements of the Federal Aviation Regulations and any and all requirements of the Department of Homeland Security and the Transportation Security Administration applicable to Lessee. The Lessee agrees to comply with the Airport Security Program and the Air Operations Area (AOA) Vehicle Access Program, as may be amended from time to time, as approved by the Federal Aviation Administration, and to comply with such other rules and regulations as may be reasonably required by the City, and to take such steps as may be necessary or directed by the City to insure that sublessees, employees, invitees and guests observe these requirements. If required by the Airport Manager, Lessee shall conduct background checks of its employees in accordance with applicable federal regulations. Lessee further agrees to be responsible for the care and maintenance of the Airport Security barriers and devices as a permanent improvement to the Premises. All costs and expenses associated with the cost of the security fence, barriers, access control and monitoring systems, including but not limited to, gates, signs or locks (keying and re-keying), which are installed now or in the future at the Premises shall be borne by the Lessee. If, as a result of the acts or omissions of Lessee, its sublessees, employees, invitees or guests, the City incurs any fines or penalties imposed by the Federal Aviation Administration or any expense in enforcing the regulations of the Federal Aviation Administration, Department of Homeland Security and the Transportation Security Administration or the rules and regulations of the City, and any expense in enforcing the Airport Security Program, then Lessee agrees to pay and reimburse to City all such costs and expenses, including all costs of administrative proceedings, court costs and attorney's fees, and all other costs and expenses incurred by City in enforcing this provision. Lessee agrees that it has the responsibility to prevent unauthorized access to the aircraft Movement Area through its Premises and will take all necessary actions to prevent such unauthorized access through its leasehold. Lessee further agrees to rectify any security deficiency or other deficiency as may be determined as such by the City or the Federal Aviation Administration. In the event Lessee fails to remedy any such deficiency, the City may do so at the cost and expense of Lessee. The City reserves the right to take whatever action is necessary to rectify any security deficiency or other deficiency. The provisions hereof shall survive the expiration or earlier termination of this Lease.

(b) Lessee shall comply with all Federal, State, and Local regulations pertaining to safety and security on the Airport. Lessee shall be held liable for any vehicles and or pedestrians that gain unauthorized access to the Movement Area through the Premises.

It shall be the responsibility of Lessee to properly secure its property to prevent unauthorized access to the Air Operations Area (AOA) and the Movement Area. Lessee shall provide wiring, conduits, and space in telecommunications closets as necessary within the Premises for the operation of any security devices that the Airport deems necessary. Lessee shall also be responsible for providing power from an electrical panel with circuit breaker protection, for any security device, including but not limited to, access controls, gates, and cameras. Energy to operate any security system will be provided by Lessee without cost to the Airport.

ARTICLE 62 MATTERS RESERVED BY THE LESSOR

(a) Lessor reserves the right to take any action it considers necessary to protect the aerial approaches of the Airport against obstruction, together with the right to prevent Lessee from erecting or permitting to be erected any building or other structure on the Airport, which, in the opinion of the Lessor would limit the usefulness of the Airport or constitute a hazard to aircraft utilizing the Airport.

(b) Lessor reserves the authority to ensure that facilities of the Airport are made available to the public on fair and reasonable terms without unjust discrimination. This Lease shall be subordinate to the authority of the Lessor to establish sufficient control over the operations of Lessee at the Airport to guarantee that patrons will be treated fairly.

(c) Lessor reserves the right to further develop and improve the Airport, including but not limited to, all landing areas and Taxiways of the Airport, as Lessor sees fit, regardless of the desires or views of Lessee, and without interference or hindrance, subject to terms of this Lease Agreement.

(d) Except to the extent required for the performance of the obligations of Lessee, nothing contained in this Agreement shall grant to Lessee any rights whatsoever in the airspace above the Premises other than those rights which are subject to Federal Aviation Administration orders, regulations or advisory circulars currently or subsequently effective. Lessor reserves the right to take any action whatsoever that it considers necessary to protect the aerial approaches of the Airport against obstruction, including but not limited to, the demolition or removal of structures upon the Premises, together with the right to prevent Lessee from erecting or permitting to be erected any building or other structure at the Airport which, in the opinion of the Lessor, would limit the usefulness of or interfere with the operations at the Airport, or constitute a hazard to aircraft.

ARTICLE 63 AMENDMENTS

(a) No modification or amendment of any terms and conditions contained herein shall be effective unless approved by the City Commission at a public meeting and contained in a written amendment executed by the City and Lessor with the same formality herewith.

(b) Should the United States government, or its agencies require changes to this Agreement, including without limitation, any nondiscrimination provisions, as a condition precedent to the granting of funds for the improvement of the Airport, or otherwise, the Lessee agrees to consent to such amendments, modifications, revisions, supplements or deletions of any terms, conditions, or requirements of this Agreement (collectively, an "amendment") as may reasonably be required. Notwithstanding the foregoing, in the event any such amendment would in Lessee's good faith judgment unreasonably interfere with the business operations of Lessee or its sublessees, then Lessee may refuse to consent to such amendment, provided that Lessee must give immediate notice to the City of any such refusal to consent and such notice must state with specificity the reasons for any such refusal. City shall have the right to immediately terminate this Agreement upon the failure of Lessee to consent to any such amendment.

ARTICLE 64 NON-EXCLUSIVE RIGHTS

Notwithstanding anything herein contained that may be, or appear to be, to the contrary, it is expressly understood and agreed that the rights granted under this Lease Agreement are non-exclusive and the Lessor reserves the right to grant similar privileges to other Lessees on other parts of the Airport.

ARTICLE 65 EXPIRATION OR TERMINATION OF LEASE AGREEMENT

Upon expiration or earlier termination of this Agreement, Lessee shall remain liable for all obligations and liabilities that have accrued after the date of this Lease and prior to the date of expiration or termination.

ARTICLE 66 RE-ENTRY AND REPOSSESSION

(a) If the Lessee shall fail to keep and perform any of the covenants, conditions and agreements provided in this Lease to be performed by Lessee, and such default shall not be remedied within the grace period provided elsewhere in this Lease, the Lessor shall have the right to treat such default as intentional, inexcusable and material, and the Lessor, by notice in writing transmitted to the Lessee, entitled "NOTICES", may at its option declare the Lessee's interest under this Lease ended and without further force and effect. Thereupon the Lessor is authorized to re-enter and repossess the Premises and the buildings, Improvements and personal property on them, either with or without legal process, and the Lessee does in such event waive any demand for possession of the Premises, and agrees to surrender and deliver up the Premises peaceably to Lessor. In the event of such action, the Lessee shall have no claim whatsoever against the Lessor by reason of Improvements made upon the Premises, rents paid, or from any other cause whatsoever.

(b) The provisions of this Paragraph shall not be construed so as to divest the Lessor, in the event of such default, of any legal right or remedy which it may have by

statutory or common law, enforceable at law or in equity. It is intended that the provisions of this Paragraph shall afford to the Lessor a cumulative remedy, in addition to such other remedy or remedies as the law affords a Lessor when the terms of a lease have been breached by a Lessee.

ARTICLE 67 NONWAIVER

Failure of the Lessor to insist upon the strict performance of any of the covenants, conditions and agreements of this Lease in any one or more instances, shall not be construed as a waiver or relinquishment of any rights under this Lease Agreement including but not limited to rights to terminate the Lease, rights to damages, or any other relief in accordance with this Lease Agreement and Florida law.

ARTICLE 68 MATTERS RESERVED BY THE LESSOR

(a) Lessor reserves the right to take any action it considers necessary to protect the aerial approaches of the Airport against obstruction, together with the right to prevent Lessee from erecting or permitting to be erected any building or other structure on the Airport, which, in the opinion of the Lessor would limit the usefulness of the Airport or constitute a hazard to aircraft utilizing the Airport.

(b) Lessor reserves the authority to ensure that facilities of the Airport are made available to the public on fair and reasonable terms without unjust discrimination. This Lease shall be subordinate to the authority of the Lessor to establish sufficient control over the operations of Lessee at the Airport to guarantee that patrons will be treated fairly.

(c) Lessor reserves the right to further develop and improve the Airport, including but not limited to, all landing areas and Taxiways of the Airport, as Lessor sees fit, regardless of the desires or views of Lessee, and without interference or hindrance, subject to Paragraph 14 of this Lease Agreement.

(d) Except to the extent required for the performance of the obligations of Lessee, nothing contained in this Agreement shall grant to Lessee any rights whatsoever in the airspace above the Premises other than those rights which are subject to Federal Aviation Administration orders, regulations or advisory circulars currently or subsequently effective. Lessor reserves the right to take any action whatsoever that it considers necessary to protect the aerial approaches of the Airport against obstruction, including but not limited to, the demolition or removal of structures upon the Premises, together with the right to prevent Lessee from erecting or permitting to be erected any building or other structure at the Airport which, in the opinion of the Lessor, would limit the usefulness of or interfere with the operations at the Airport, or constitute a hazard to aircraft.

**ARTICLE 69
SUCCESSORS IN INTEREST**

The covenants and agreements contained in this Lease Agreement shall be binding on and inure to the benefit of the respective successors and assigns of the parties. Wherever used, the singular shall include the plural, and the use of any gender shall be applicable to all genders.

**ARTICLE 70
ALL PRIOR AGREEMENTS SUPERSEDED**

This document incorporates and includes all prior negotiations, correspondence, conversations, agreements or understandings applicable to the matters contained herein and the parties agree that there are no commitments, agreements or understandings concerning the subject matter of this Agreement that are not contained in this document. Accordingly, it is agreed that no deviation from the terms hereof shall be predicated upon any prior representations or agreement whether oral or written.

**ARTICLE 71
DERELICT AIRCRAFT**

Lessee and all sublessees shall not permit the temporary or permanent storage at the Premises of any Derelict Aircraft. A Derelict Aircraft is (1) an aircraft that does not hold a current and valid airworthiness certificate issued by the FAA or other appropriate certifying authority, together with the necessary aircraft registration and maintenance records with a current endorsement by an appropriately rated certificate holder that the aircraft is in an airworthy condition; or (2) an aircraft that has been issued a condition notice by the FAA specifying that the aircraft has one or more conditions rendering it unairworthy; or (3) an aircraft which has had major components, accessories, flight controls, portions of the airframe or engines removed so as to render the aircraft unflyable. With respect to Derelict Aircraft, the Airport Manager of City may make a written request to the Lessee to demonstrate that an open work order for repair or restoration is being actively pursued by Lessee or the sublessee. If the Lessee fails to provide the Airport Manager with satisfactory evidence that an open work order is being actively pursued within fourteen (14) days of the request from the Airport Manager, then such Derelict Aircraft shall be removed from the Premises by the Lessee within ninety (90) days following the date of the Airport Manager's request. Any Derelict Aircraft that is not removed from the Premises as provided in this subparagraph shall constitute a breach of this Lease Agreement.

**ARTICLE 72
DERELICT VEHICLES**

Lessee and all sublessees shall not permit the temporary or permanent storage at the Premises of any other derelict vehicle whatsoever. A derelict vehicle is a vehicle that does not display a current and valid state license tag. Any derelict vehicle that is not removed

from the Premises within thirty (30) days after notice from the City will constitute a material breach of this Agreement.

ARTICLE 73 EMERGENCY EVACUATION AND HURRICANE PLAN

Within thirty (30) days of the date of this Agreement, Lessee shall prepare an emergency evacuation and hurricane plans consistent with any existing plans for the Airport. These plans shall constitute detailed procedures of actions to be taken by Lessee and its sublessees, in the event the need for evacuation or a hurricane alert warning arises. Notwithstanding the forgoing, the Premises will remain operational by Lessee, to the extent possible and in coordination with City's Airport Manger's emergency operational procedures, during emergency events (man-made or national disasters) and during recovery efforts.

ARTICLE 74 REGULATORY APPROVALS

Lessee agrees to cooperate with City in connection with City's efforts to obtain Regulatory Approvals, including but not limited to Airport FAR Part 150 Program and any updates thereto, Airport Master Plan Updates, and any approvals required pursuant to Chapter 380 and Chapter 333, Florida Statutes. From and after the date of execution of this Lease, Lessee covenants and agrees (i) to support the City's efforts to obtain the Regulatory Approvals; and (ii) to execute any document(s) or instrument(s) reasonably required by the City in order to assist City in obtaining the Regulatory Approvals, provided that Lessee shall not be required to bear any expense in connection therewith and that Lessee shall not be deemed an agent of the City.

ARTICLE 75 OPERATIONAL REPORTS

Lessee agrees to submit to Lessor upon reasonable request by Lessor any report or reports or information regarding Lessee's operations at the Airport, including, but not limited to, passenger counts, flight operations, number of aircraft serviced, and matters of a similar nature. The Lessor agrees to receive from Lessee, upon request by Lessee, any reports the Lessee deems appropriate for the purpose of keeping the Lessor informed of any operational problems and of any suggested improvements at the Airport.

ARTICLE 76 CONDUCT OF OPERATIONS

Lessee and all sublessees shall conduct their operations under this Lease in an orderly and commercially reasonable manner, based on the nature of the operations, so as not to annoy, disturb, endanger or be offensive to others at the Airport.

**ARTICLE 77
ADHERENCE TO NOISE REGULATIONS**

Lessee and all sublessees shall take all reasonable care to reduce to a minimum vibrations tending to damage any equipment, structure, building or portion of a building which is on the Premises or is a part thereof, or is located elsewhere on the Airport, and to keep the sound level of their operations as low as possible. The parties agree that aircraft operating within federal noise requirements shall not be deemed in violation of this provision.

**ARTICLE 78
KEYS AND LOCKS**

The Lessee shall at its own expense provide copies of all keys for the Leased Premises to all Assignee(s) or Sub-tenant(s) that are approved and authorized in accordance with the terms of this Lease Agreement. In the event that keys are not provided to the Assignee or Sub-tenant, the Assignee or Sub-Tenant shall pay for and obtain keys at their own expense.

**ARTICLE 79
ZONING**

The Lessee accepts the zoning of the Premises, which Lessor represents and warrants is General Aviation Airport ("GAA") as of the commencement of the term of this Lease Agreement, which zoning is compatible and consistent with the usages and purposes contemplated in this Agreement. Lessee further accepts the existing zoning ordinances of the Unified Land Development Regulations of the City of Fort Lauderdale insofar as they are applicable to the Premises.

**ARTICLE 80
RESTRAINTS UPON LESSEE**

Lessee understands and agrees that it is expressly subject to all applicable zoning restrictions and all rules, regulations and City ordinances pertaining to the Airport.

**ARTICLE 81
LESSEE IMPROVEMENTS**

The Lessee shall make capital expenditures of no less than \$6,000,000.00 to vastly improve the hangar structure and curb front appeal. The Lessee shall provide written documentation to the Airport Director by no later than sixty (60) days evidencing proof that the Lessee has expended a minimum of \$6,000,000.00 for the improvements completed. The Lessee is required to make improvements on Parcel 2A which include but are not limited to the following: construct new hangar doors and exterior metal panels, add new stucco on the office building, add new HVAC equipment throughout entire facility, complete a full remodel of existing interior offices, complete an overhaul underground fuel storage system, add new offices, add new impact windows, add a back-up generator, and add landscaping. The Lessee's required improvements are illustrated

in the attached **EXHIBIT "C"**. These improvements are subject to the approval of the Airport Director and the requirements in the City's Code of Ordinances and Unified Land Development Regulations. ~~For good cause shown, the Airport Director shall have in his or her sole discretion, the authority to extend the construction deadline and CO date by a period not to exceed three (3) months.~~ These improvements must be completed by no later than April 30, 2023.

IN WITNESS WHEREOF, the City and Lessee have hereunto set their hands and seals the day and year first above written.

WITNESSES:

CITY OF FORT LAUDERDALE

By: _____
GREG CHAVARRIA, City Manager

Print Name

Print Name

ATTEST:

(CORPORATE SEAL)

DAVID R. SOLOMAN, City Clerk

Approved as to form:

SHARI C. WALLEN
Assistant City Attorney

LESSEE

WITNESSES:

MNREH FLORIDA, LLC

By: _____
DAVID MACNEIL, MANAGER

[Witness print name]

[Witness print name]

[COMPANY SEAL]

STATE OF FLORIDA:
COUNTY OF _____:

The foregoing instrument was acknowledged before me by means of physical presence or online notarization, this ____ day of _____, 20__, by David MacNeil as a Manager of MNREH FLORIDA, LLC, a Florida Limited Liability Company.

(SEAL)

Signature of Notary Public – State of Florida

Print, Type, or Stamp Commissioned Name of Notary Public

Personally Known ____ OR Produced Identification ____
Type of Identification Produced _____

EXHIBIT A
LEASED PREMISES
LEGAL DESCRIPTION AND MAILING ADDRESS

**Mailing Address: MNREH FLORIDA, LLC, a Florida Limited Liability Company,
84 Isla Bahia Drive, Fort Lauderdale, Florida 33316**

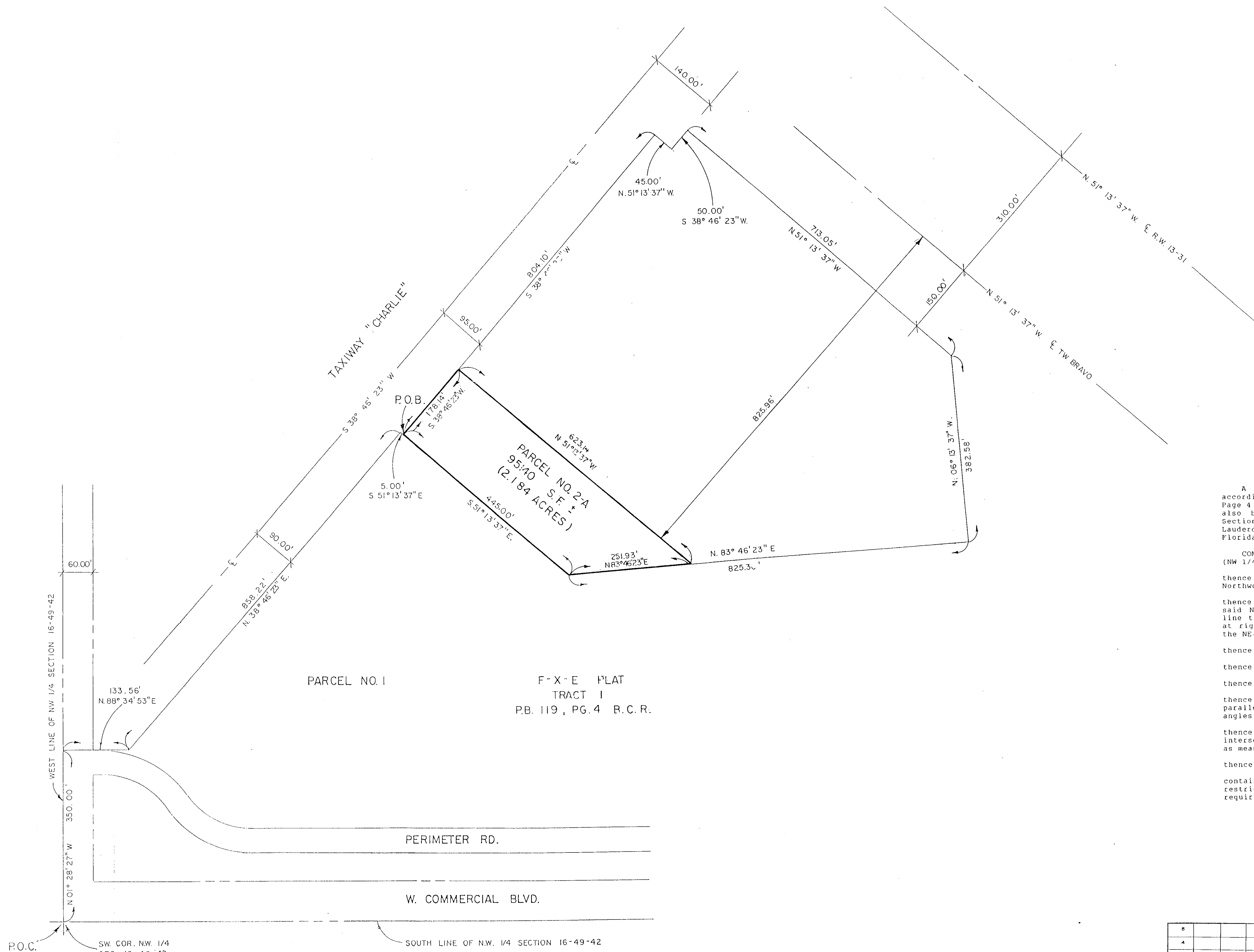
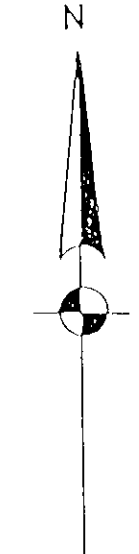

LEGAL DESCRIPTION
Parcel 2A
Fort Lauderdale Executive Airport

A parcel of land that is a portion of TRACT 1, "F-X-E PLAT" according to the plat thereof, as recorded in Plat Book 119 at Page 4 of the Public Records of Broward County, Florida, said land also being a portion of the Northwest one-quarter (NW 1/4) of Section 16, Township 49 South, Range 42 East, in the City of Fort Lauderdale and in Fort Lauderdale Executive Airport, Broward County, Florida, more particularly located and described as follows:

COMMENCE at the Southwest corner of said Northwest one-quarter (NW 1/4) of said Section 16;

thence 350.00 feet N 01° 28' 27" W on the West line of said Northwest one-quarter (NW 1/4);

thence 133.56 feet N 88° 34' 53" E parallel with the South line of said Northwest one-quarter (NW 1/4) of Section 16 to intersect a line that is parallel with and 90.00 feet southeasterly as measured at right angles from the centerline of Taxiway "Charlie" (formerly the NE-SW runway);

thence 858.22 feet N 38° 46' 23" E on said parallel line;

thence 5.00 feet S 51° 13' 37" E to the POINT OF BEGINNING;

thence continue 445.00 feet S 51° 13' 37" E;

thence 251.93 feet N 83° 46' 23" E to intersect a line that is parallel with and 825.96 feet southwesterly as measured at right angles from the centerline of Taxiway "Bravo";

thence 623.14 feet N 51° 13' 37" W on said parallel line to intersect a line that is parallel with and 95.00 feet southeasterly as measured at right angles from the centerline of Taxiway "Charlie";

thence 178.14 feet S 38° 46' 23" W to the POINT OF BEGINNING;

containing 95,140 square feet, more or less (2.184 acres);

restricting building heights to avoid obstructions to aviation as required by CRF 14, Subchapter "E" (Airspace), Part 77.

CITY OF FORT LAUDERDALE, FLORIDA

PROJECT 8500
EXECUTIVE AIRPORT
PARCEL 2-A
EXHIBIT "A"

NO.	DATE	BY	CHK.	REMARKS
5				
4				
3				
2				
1				

V.V. DRAWN BY	7/89
A. K. R. CHECKED BY	1"=100' SCALE
N/A FIELD BOOK	1 OF 1 SHEET

REVISIONS

EXHIBIT B

REQUIRED FEDERAL PROVISIONS

To the extent permitted by Applicable Law, the provisions of Sections B.3 and B.6 below of this **Exhibit B** shall be applicable with respect to the Leased Premises and, where applicable, for contracts and subcontracts Lessee enters into and solicitations Lessee issues on and after the Effective Date of the Lease to which this **Exhibit B** is attached.

- A. **Civil Rights – General.** Lessee agrees to comply with pertinent statutes, Executive Orders and such rules as are promulgated to ensure that no person shall, on the grounds of race, creed, color, national origin, sex, age, or disability be excluded from participating in any activity conducted with or benefiting from Federal assistance. If Lessee transfers its obligation to another, the transferee is obligated in the same manner as Lessee.

This provision obligates Lessee for the period during which the Leased Premises is owned, Leased, used or possessed by Lessee and the City remains obligated to the Federal Aviation Administration. This provision is in addition to that required by Title VI of the Civil Rights Act of 1964.

- B. **Civil Rights – Title VI Assurances – Compliance with Nondiscrimination Requirements.**

1. **Compliance with Regulations:** Lessee (hereinafter includes consultants) will comply with the Title VI List of Pertinent Nondiscrimination Acts and Authorities, as they may be amended from time to time, which are herein incorporated by reference and made a part of this contract.

2. **Non-discrimination:** Lessee, with regard to the work performed by it during the Term of the Lease, will not discriminate on the grounds of race, color, or national origin in the selection and retention of subcontractors, including procurements of materials and leases of equipment. Lessee will not participate directly or indirectly in the discrimination prohibited by the Nondiscrimination Acts and Authorities, including employment practices when the Lease covers any activity, project, or program set forth in Appendix B of 49 CFR part 21.

3. **Solicitations for Subcontracts, including Procurements of Materials and Equipment:** In all solicitations, either by competitive bidding or negotiation made by Lessee for work to be performed under a subcontract, including procurements of materials, or leases of equipment, each potential subcontractor or supplier will be notified by Lessee of Lessee's obligations under this Lease and the Nondiscrimination Acts and Authorities on the grounds of race, color, or national origin.

4. **Information and Reports:** Lessee will provide all information and reports required by the Acts, the Regulations, and directives issued pursuant thereto and will permit access to its books, records, accounts, other sources of information, and its facilities as may be determined by the City or the Federal Aviation Administration to be pertinent to ascertain compliance with such Nondiscrimination Acts and Authorities and instructions. Where any information required of Lessee is in the exclusive possession of another who fails or refuses to furnish the information, Lessee will so certify to the City or the Federal Aviation Administration, as appropriate, and will set forth what efforts it has made to obtain the information.

5. **Sanctions for Noncompliance:** In the event of Lessee's noncompliance with the non-discrimination provisions of this Lease, the City will impose such contract sanctions as it or the Federal Aviation Administration may determine to be appropriate, including, but not limited to:

(a) Withholding payments to Lessee under the Lease until Lessee complies; and/or

(b) Cancelling, terminating or suspending the Lease, in whole or in part.

6. **Incorporation of Provisions:** Lessee will include the provisions of paragraphs one through six in every subcontract, including procurements of materials and leases of equipment, unless exempt by the Acts, the Regulations, and directives issued pursuant thereto. Lessee will take action with respect to any subcontract or procurement as the City or the Federal Aviation Administration may direct as a means of enforcing such provisions including sanctions for noncompliance. Provided, that if Lessee becomes involved in, or is threatened with litigation by a subcontractor, or supplier because of such direction, airline may request the City to enter into any litigation to protect the interests of the City. In addition, Lessee may request the United States to enter into the litigation to protect the interests of the United States.

7. **Civil Rights – Title VI Clauses for Use/Access to Real Property.** Lessee for itself, its heirs, personal representatives, successors in interest, and assigns, as a part of the consideration hereof, does hereby covenant and agree that (1) no person on the ground of race, color, or national origin, will be excluded from participation in, denied the benefits of, or be otherwise subjected to discrimination in the use of the Leased Premises or the Airport, (2) that in the construction of any improvements on, over, or under such land, and the furnishing of services thereon, no person on the ground of race, color, or national origin, will be excluded from participation in, denied the benefits of, or otherwise be subjected to discrimination, (3) that Lessee will use the premises in compliance with all other requirements imposed by or pursuant to the List of Pertinent Nondiscrimination Acts And Authorities in Paragraph C below.

In the event of breach of any of the above nondiscrimination covenants, the City will have the right to terminate the Lease and to enter or re-enter and repossess

said land and the facilities thereon, and hold the same as if said Lease had never been made or issued.

C. **Title VI List of Pertinent Nondiscrimination Acts and Authorities.** During the performance of this Lease, Lessee, for itself, its assignees, and successors in interest (hereinafter referred to as “Lessee”) agrees to comply with the following non-discrimination statutes and authorities; including but not limited to:

1. **Title VI of the Civil Rights Act of 1964** (42 USC § 2000d *et seq.*, 78 stat. 252) (prohibits discrimination on the basis of race, color, national origin);
2. **49 CFR part 21** (Non-discrimination in Federally-assisted programs of the Department of Transportation — Effectuation of Title VI of the Civil Rights Act of 1964);
3. **The Uniform Relocation Assistance and Real Property Acquisition Policies Act of 1970** (42 USC § 4601) (prohibits unfair treatment of persons displaced or whose property has been acquired because of Federal or Federal-aid programs and projects);
4. **Section 504 of the Rehabilitation Act of 1973** (29 USC § 794 *et seq.*), as amended (prohibits discrimination on the basis of disability); and 49 CFR part 27;
5. **The Age Discrimination Act of 1975**, as amended (42 USC § 6101 *et seq.*), (prohibits discrimination on the basis of age);
6. **Airport and Airway Improvement Act of 1982** (49 USC § 471, Section 47123), as amended (prohibits discrimination based on race, creed, color, national origin, or sex);
7. **The Civil Rights Restoration Act of 1987** (PL 100-209) (broadened the scope, coverage and applicability of Title VI of the Civil Rights Act of 1964, the Age Discrimination Act of 1975 and Section 504 of the Rehabilitation Act of 1973, by expanding the definition of the terms “programs or activities” to include all of the programs or activities of the Federal-aid recipients, sub-recipients and contractors, whether such programs or activities are Federally funded or not);
8. **Titles II and III of the Americans with Disabilities Act of 1990**, which prohibit discrimination on the basis of disability in the operation of public entities, public and private transportation systems, places of public accommodation, and certain testing entities (42 USC §§ 12131 – 12189) as implemented by U.S. Department of Transportation regulations at 49 CFR parts 37 and 38;

9. **The Federal Aviation Administration's Nondiscrimination statute** (49 USC § 47123) (prohibits discrimination on the basis of race, color, national origin, and sex);
10. **Executive Order 12898, Federal Actions to Address Environmental Justice in Minority Populations and Low-Income Populations**, which ensures nondiscrimination against minority populations by discouraging programs, policies, and activities with disproportionately high and adverse human health or environmental effects on minority and low-income populations;
11. **Executive Order 13166, Improving Access to Services for Persons with Limited English Proficiency**, and resulting agency guidance, national origin discrimination includes discrimination because of limited English proficiency (LEP). To ensure compliance with Title VI, you must take reasonable steps to ensure that LEP persons have meaningful access to your programs (70 Fed. Reg. at 74087 to 74100);
12. **Title IX of the Education Amendments of 1972**, as amended, which prohibits you from discriminating because of sex in education programs or activities (20 USC 1681 et seq).

EXHIBIT C

LESSEE REQUIRED IMPROVEMENTS



DEPARTMENT OF SUSTAINABLE DEVELOPMENT
 BUILDING DIVISION
 APPROVED 5/3/2022
 BLD-CALT-21100020
 CITY OF FORT LAUDERDALE

EXHIBIT C



888 SOUTH ANDREWS AVE. SUITE 300
 FORT LAUDERDALE, FLORIDA 33316
 PH:(954)764-6575 FAX:(954)764-8622

COPYRIGHT 2020
 FSMY ALL RIGHTS RESERVED.
 THIS DOCUMENT OR PARTS THEREOF MAY NOT
 BE REPRODUCED IN ANY FORM WITHOUT PERMISSION

CA # AAC000447

DESIGNED	DRAWN	CHECKED
Designer	Author	Checker



REVISIONS

DATE:	COMM:
10.04.21	21025

WeatherTech-
 HANGER
 RENOVATION

1815 NW 51st PL FORT LAUDERDALE, FL 33309

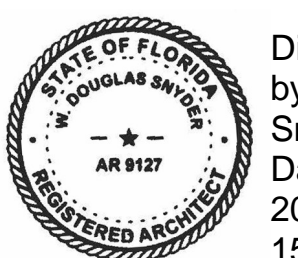

Digitally signed
 by W. Douglas
 Snyder
 Date:
 2021.10.18
 15:07:26-04'00'

COVER

PERMIT SET

.G-001

WeatherTech® HANGAR RENOVATION

MILLER CONSTRUCTION

5750 Powerline Road
 Fort Lauderdale, FL 33309
 954.764.6550

FSMY ARCHITECTS

888 South Andrews Avenue
 Fort Lauderdale, FL 33316
 954.764.6575

BARRANCO, RLA

888 South Andrews Avenue
 Fort Lauderdale, FL 33442
 954.764.6575

KAMM CONSULTING

1407 West Newport Center Drive
 Deerfield Beach, FL 33442
 954.949.2200

BRYNTESEN STRUCTURAL ENGINEERS

3045 N. FEDERAL HIGHWAY, BLDG. #80
 Fort Lauderdale, FL 33306
 954.568.1411

10/18/2021 2:47:54 PM

Symbol	Qty	Label	Arrangement	LLF	Description
☐	9	S1	SINGLE	0.900	Cree Lighting OSQ-L-B-22L-40K7-3M-XX-NM-XX, Single Head
☐	4	W2	SINGLE	0.900	Xtra Light VNTW-5500L-40K-DIM-3M-BZ
⊙	8	W1A	SINGLE	0.900	PIL ALU Round Mini Trim - 077285

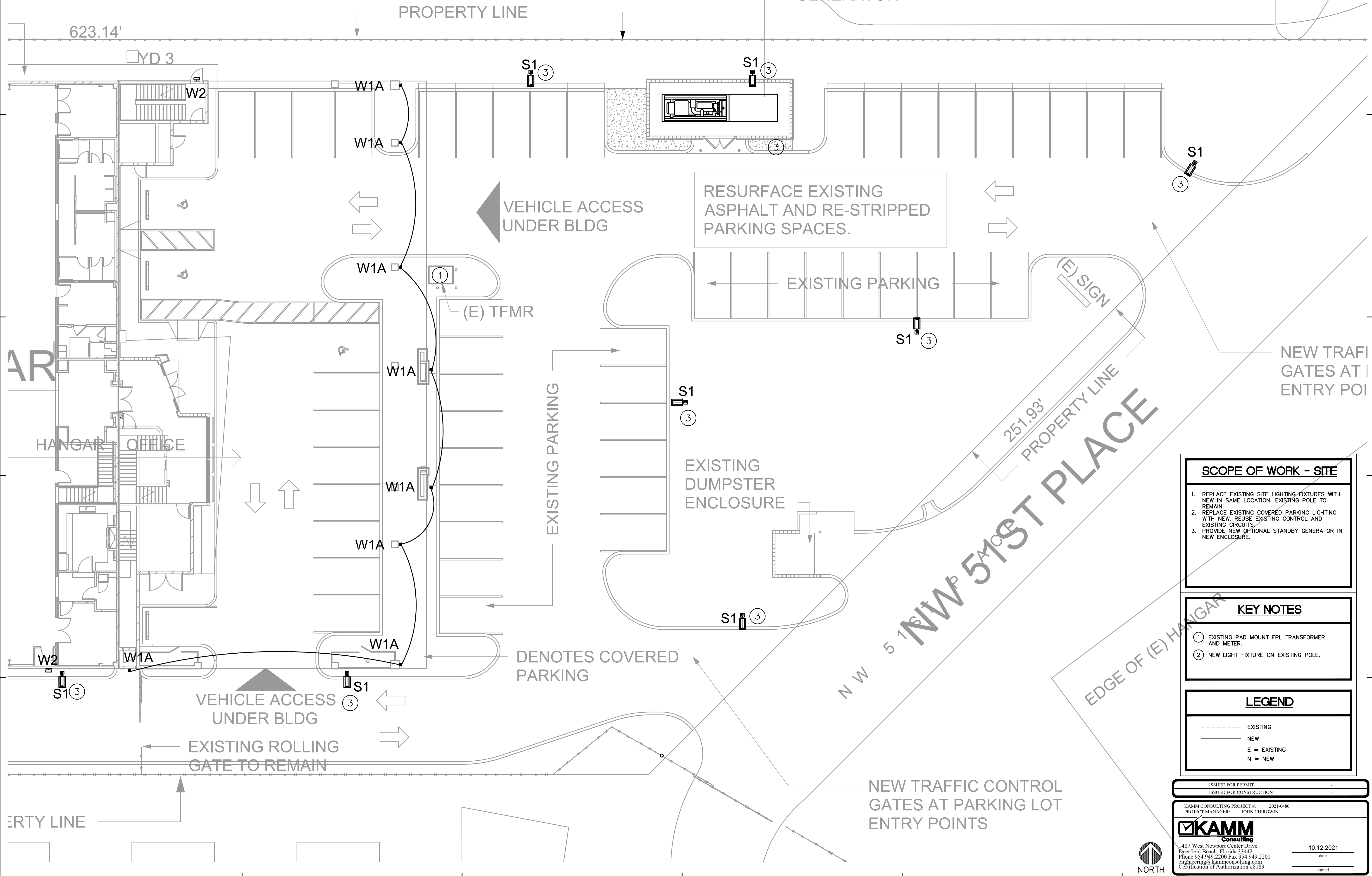

SCOPE OF WORK - SITE

1. REPLACE EXISTING SITE LIGHTING-FIXTURES WITH NEW IN SAME LOCATION. EXISTING POLE TO REMAIN.
2. REPLACE EXISTING COVERED PARKING LIGHTING WITH NEW. REUSE EXISTING CONTROL AND EXISTING CIRCUITS.
3. PROVIDE NEW OPTIONAL STANDBY GENERATOR IN NEW ENCLOSURE.

KEY NOTES

1. EXISTING PAD MOUNT FPL TRANSFORMER AND METER.
2. NEW LIGHT FIXTURE ON EXISTING POLE.

LEGEND

- EXISTING
- NEW
- E = EXISTING
- N = NEW

ISSUED FOR PERMIT
 ISSUED FOR CONSTRUCTION

KAMM CONSULTING PROJECT #: 2021-0480
 PROJECT MANAGER: JOHN CHIRGWIN

KAMM Consulting
 1407 West Newport Center Drive
 Deerfield Beach, Florida 33442
 Phone: 954.949.2200 Fax: 954.949.2201
 engineering@kammconsulting.com
 Certification of Authorization #8189

10.12.2021
 date
 signed

REVISIONS

DATE: 07/20/31 COMM: 21025

WeatherTech-
 HANGER
 RENOVATION

1815 NW 51st PL FORT LAUDERDALE, FL 33309

SITE POWER PLAN

PERMIT DRAWINGS

E2.1

PRINTED ON: 08.08.2021

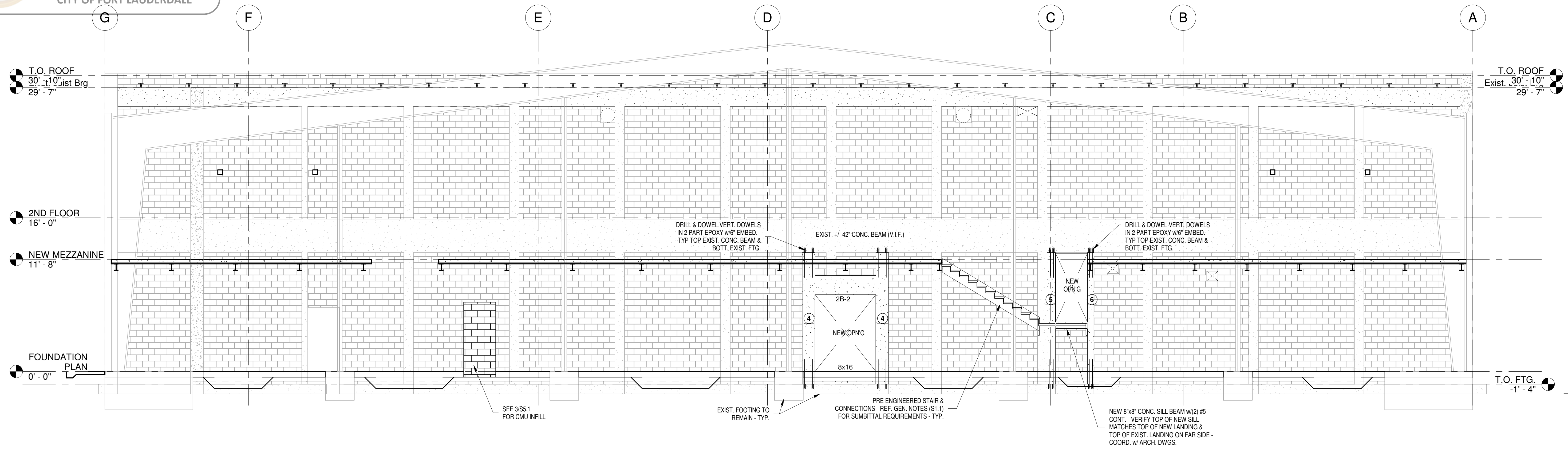

1 EXISTING WALL ELEVATION
 S3.0 3/16" = 1'-0"

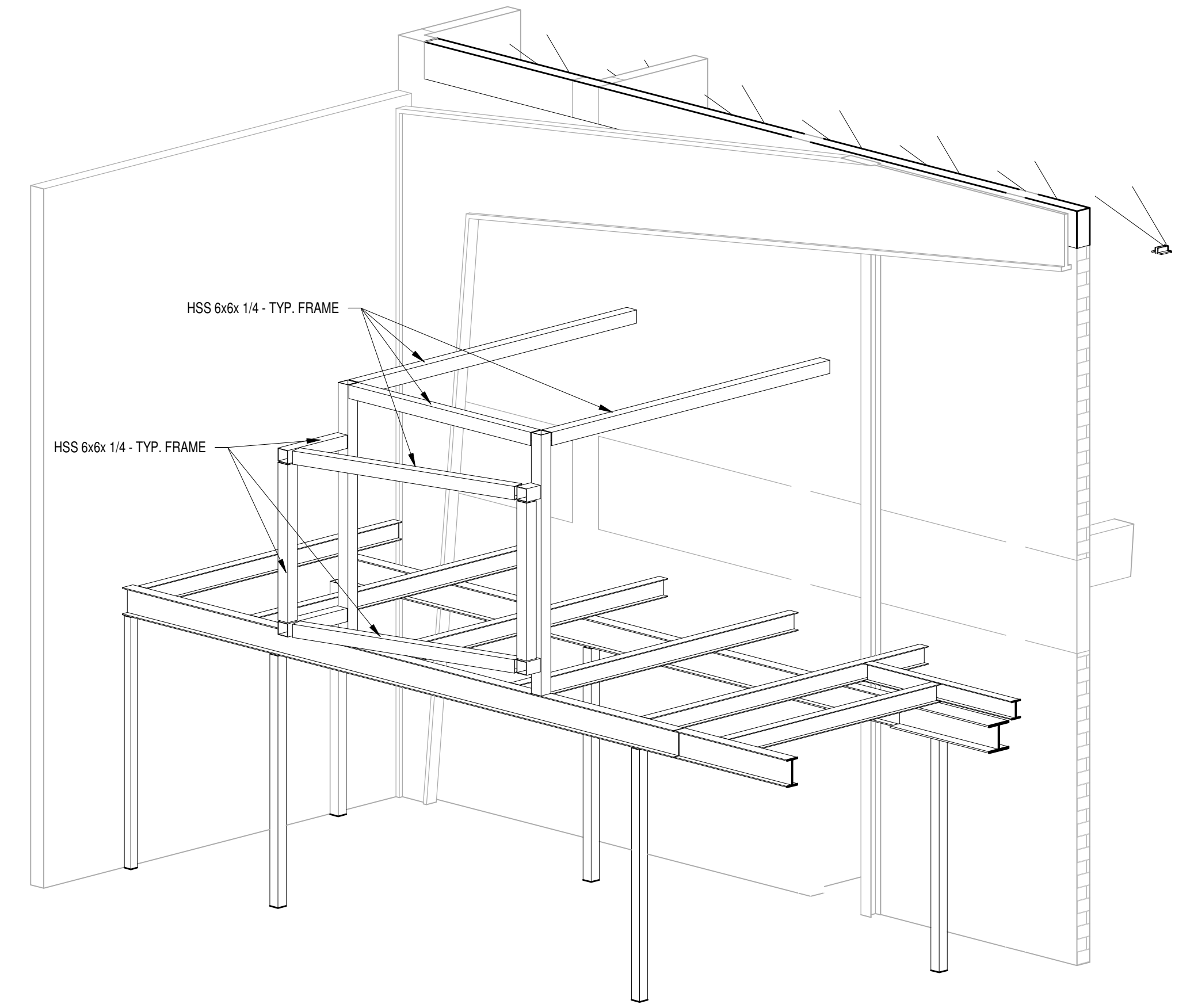

2 TYP. SCREEN FRAME
 S3.0

DESIGNED	DRAWN	CHECKED
Designer	Author	Checker

REVISIONS	
DATE:	COMM:
10.04.21	21025

WeatherTech-
 HANGER
 RENOVATION

1815 NW 51st PL FORT LAUDERDALE, FL 33309

PERMIT SET 10/04/21

BRYNTESEN
 STRUCTURAL ENGINEERS
 EB 5099
 3045 North Federal Highway - Building #80
 Fort Lauderdale, Florida 33306
 TEL: (954) 568-1411 FAX: (954) 568-9367
 Project No: 21025 DATE: 10.04.21
 Email: bryntesen@bryntesen.com

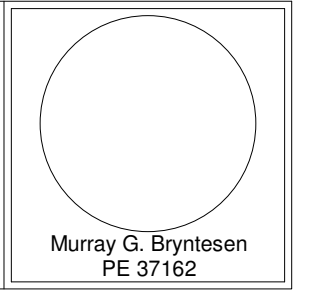

ELEVATION VIEWS

S3.0

10/4/2021 12:59:35 PM

LIFE SAFETY NOTES

- COORDINATE FIRE ALARM DEVICES AND PANELS WITH ELECTRICAL DRAWINGS
- REFER TO FIRE PROTECTION DRAWINGS FOR SPRINKLER HEAD LOCATIONS
- REFER TO ELECTRICAL DRAWINGS FOR FIRE ALARM DEVICE LOCATIONS
- REFER TO ELECTRICAL DRAWINGS FOR EMERGENCY LIGHT LOCATIONS
- FLAMMABLE MATERIALS: ALL FLAMMABLE MATERIALS USED DURING CONSTRUCTION MUST COMPLY WITH NFPA SECTIONS 16.2.3.1.1, 16.2.3.1.2, 16.2.3.1.3, 16.2.3.1.4, 16.2.3.1.5, 16.2.3.2.1, AND 16.2.3.2.3
- ALL MSDS SHEETS FOR CONSTRUCTION MATERIALS TO BE STORED IN THE GENERAL CONTRACTOR'S TRAILER
- 4A TYPE FIRE EXTINGUISHER WILL BE IN PLACE DURING CONSTRUCTION. THE FIRE EXTINGUISHER NEEDS TO COMPLY WITH NFPA 16.3.9.1, 16.3.9.3, 16.3.9.4, 1141-10.1.5, AND 1141-10.1.5.1
- ORDINARY HAZARD OF CONTENTS (NFPA 38.1.5.1)
- SEE FLOOR PLAN FOR RATED WALL TYPE INFORMATION

LIFE SAFETY LEGEND

- ◆ DENOTES 2 HOUR RATED FIRE BARRIER
- ⊙ DENOTES WALL MOUNTED EXIT SIGN
- ⊙ DENOTES CEILING MOUNTED DIRECTIONAL EXIT SIGN
- DENOTES MAXIMUM TRAVEL DISTANCE AS PER FBC TABLE 1017.2
- DENOTES COMMON PATH OF TRAVEL DISTANCE AS PER FBC TABLE 1006.2.1
- FEC SEMI-RECESSED TYPE ABC FIRE EXTINGUISHER AND CABINET. EXTINGUISHERS SHALL BE CURRENTLY DATED AND TAGGED BY LICENSED FIRE EQUIPMENT COMPANY, AND LOCATED NOT FURTHER THAN 75 FEET OF TRAVEL DISTANCE TO AN EXTINGUISHER. REFER TO DETAILS
- FE SURFACE MOUNTED PERMANENT FIRE EXTINGUISHER AND CABINET. EXTINGUISHERS SHALL BE CURRENTLY DATED AND TAGGED BY LICENSED FIRE EQUIPMENT COMPANY, AND LOCATED NOT FURTHER THAN 75 FEET OF TRAVEL DISTANCE TO AN EXTINGUISHER. REFER TO DETAILS
- 60 MIN DOOR FIRE RATING
- DENOTES 75' RADIUS FOR FIRE EXTINGUISHER COVERAGE
- EXIT PRIMARY MEANS OF EGRESS

REVISIONS

DATE	COMM
10.04.21	21025

**WeatherTech-
 HANGER
 RENOVATION**

1815 NW 51st PL FORT LAUDERDALE, FL 33309

Digitally signed
 by W. Douglas
 Snyder
 Date:
 2021.10.18
 15:08:10-04'00'

LEVEL 01 - LIFE SAFETY PLAN

PERMIT SET

A-001

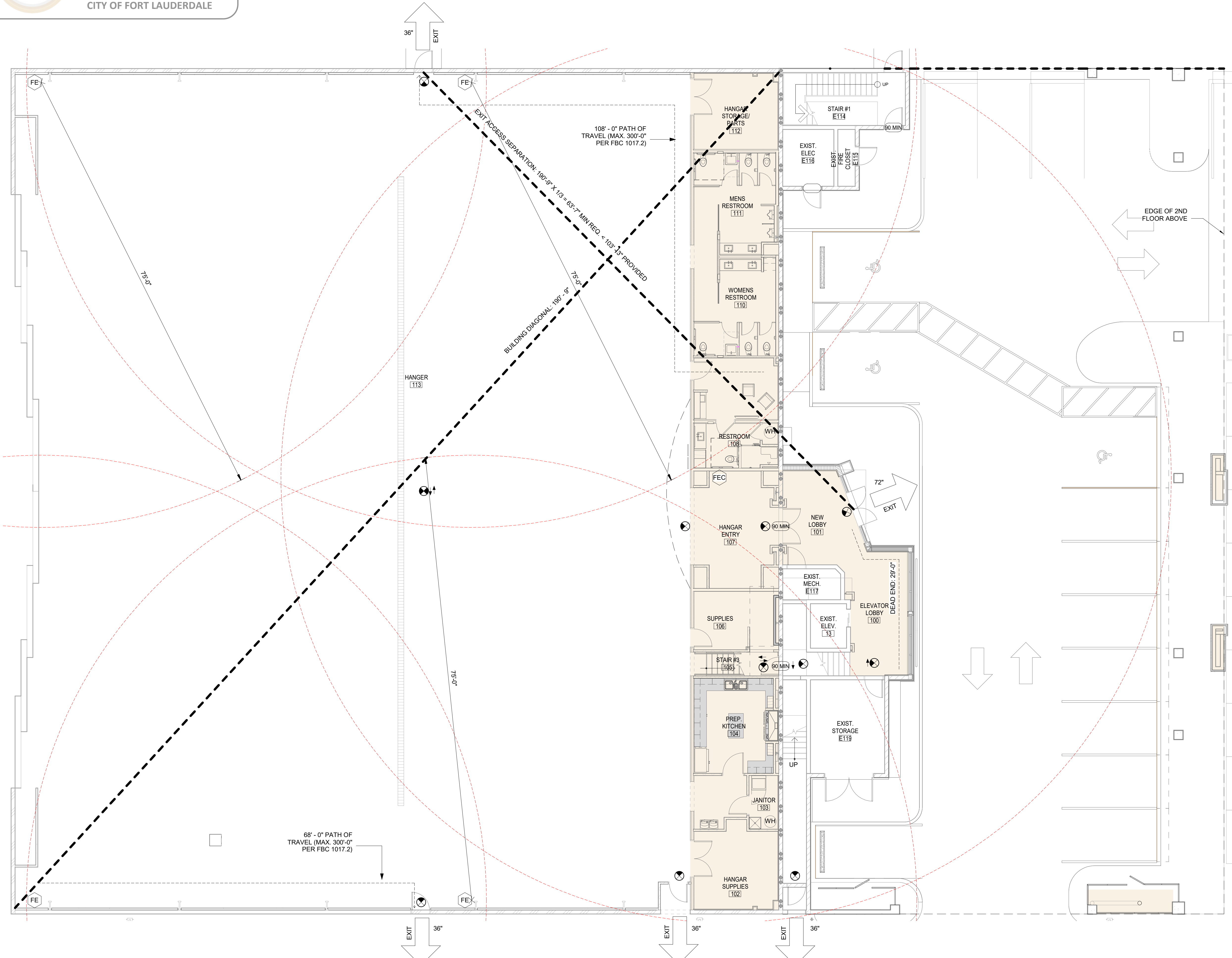

1 FIRST FLOOR PLAN
 A-001 1/8" = 1'-0"

10/18/2021 2:48:05 PM

LEGAL DESCRIPTION

LEGAL DESCRIPTION PARCEL 2-A
 A PARCEL OF LAND THAT IS A PORTION OF TRACT 1, "F-X-E PLAT" ACCORDING TO THE PLAT THEREOF, AS RECORDED IN PLAT BOOK 119 AT PAGE 4 OF THE PUBLIC RECORDS OF BROWARD COUNTY, FLORIDA. SAID LAND ALSO BEING A PORTION OF THE NORTHWEST ONE-QUARTER (NW 1/4) OF SECTION 16, TOWNSHIP 49 SOUTH, RANGE 42 EAST., IN THE CITY OF FORT LAUDERDALE AND IN FORT LAUDERDALE EXECUTIVE AIRPORT, BROWARD COUNTY, FLORIDA, MORE PARTICULARLY LOCATED AND DESCRIBED AS FOLLOWS:

COMMENCE AT THE SOUTHWEST CORNER OF SAID NORTHWEST ONE-QUARTER (NW 1/4) OF SECTION 16; THENCE 350.00 FEET N 01° 28' 27" W ON THE WEST LINE OF SAID NORTHWEST ONE-QUARTER (NW 1/4); THENCE 133.56 FEET N 88° 34' 53" E PARALLEL WITH THE SOUTH LINE OF SAID NORTHWEST ONE-QUARTER (NW 1/4) OF SECTION 16 TO INTERSECT A LINE THAT IS PARALLEL WITH AND 90.00 FEET SOUTHEASTERLY AS MEASURED AT RIGHT ANGLES FROM THE CENTERLINE OF TAXIWAY "CHARLIE" (FORMERLY THE NE-SW RUNWAY); THENCE 858.22 FEET N 38° 46' 23" E ON SAID PARALLEL LINE; THENCE 5.00 FEET S 51° 13' 37" E TO THE POINT OF BEGINNING; THENCE CONTINUE 445.00 FEET S 51° 13' 37" E; THENCE 251.93 FEET N 83° 46' 23" E TO INTERSECT A LINE THAT IS PARALLEL WITH AND 825.96 FEET SOUTHWESTERLY AS MEASURED AT RIGHT ANGLES FROM THE CENTERLINE OF TAXIWAY "BRAVO"; THENCE 623.14 FEET N 51° 13' 37" W ON SAID PARALLEL LINE TO INTERSECT A LINE THAT IS PARALLEL WITH AND 95.00 FEET SOUTHEASTERLY AS MEASURED AT RIGHT ANGLES FROM THE CENTERLINE OF TAXIWAY "CHARLIE"; THENCE 178.14 FEET S 38° 46' 23" W TO THE POINT OF BEGINNING. CONTAINING 95,140 SQUARE FEET, MORE OR LESS (2.184 ACRES); RESTRICTING BUILDING HEIGHTS TO AVOID OBSTRUCTIONS TO NAVIGATION AS REQUIRED BY CRF 14, SUBCHAPTER "E" (AIRSPACE), PART 77.

DESIGNED	DRAWN	CHECKED
Designer	Author	Checker

SITE PLAN DATA TABLE

A. EXISTING BUILDING USE	MINI-WAREHOUSE, SELF STORAGE
B. ZONING DESIGNATION	GAA
C. FLOOD ZONE	X 0.2 PCT ANNUAL CHANCE FLOOD HAZARD Broward County
D. WATER/WASTE WATER SERVICE PROVIDED BY	CITY OF FORT LAUDERDALE
E. SITE AREA	95,139 SQ. FT. (2.18 ACRES)
F. BUILDING FOOTPRINT	19,933 SQ. FT.
G. LANDSCAPE AREA (VUA X 20%) 14,053 SQ. FT. X 20% = 2,811 SQ. FT.	
REQUIRED VUA LANDSCAPE:	2,811 SQ. FT.
PROVIDED VUA LANDSCAPE:	14,053 SQ. FT.
PROVIDED REMAINING LANDSCAPE: (COVERED PARKING)	1,608 SQ. FT.
TOTAL PROVIDED LANDSCAPE AREA:	15,661 SQ. FT.
H. OPEN SPACE:	62,483 SQ. FT.
I. LINEAR FEET OF NEW SIDEWALK	163' - 0"

POLICE

- ALL EXTERIOR WINDOWS AND DOORS TO BE IMPACT RATED
- STAIRWELL'S EGRESS ONLY ON FIRST LEVEL

FIRE PROTECTION

- PROJECT SHALL COMPLY WITH ALL APPLICABLE SECTIONS OF NFPA AND THE FLORIDA BUILDING CODE
- PER FBC 903.2.11.3 BUILDING WILL HAVE FIRE SPRINKLERS

KEY NOTES

- 107 DENOTES EXISTING POLE MOUNTED LIGHT FIXTURE. FIXTURE HEAD TO BE REPLACED WITH NEW LED. REFER TO ELECTRICAL AND PHOTOMETRIC PLANS FOR MORE INFORMATION.

3	REV 03- PERMIT COMMENTS	04.12.22
---	-------------------------	----------

REVISIONS

DATE:	COMM:
10.04.21	21025

**WeatherTech-
 HANGER
 RENOVATION**

1815 NW 51st PL FORT LAUDERDALE, FL 33309

Digitally signed by W. Douglas Snyder
 Date: 2022.04.12 08:11:55-04'00'

SITE PLAN

PERMIT SET

A-100

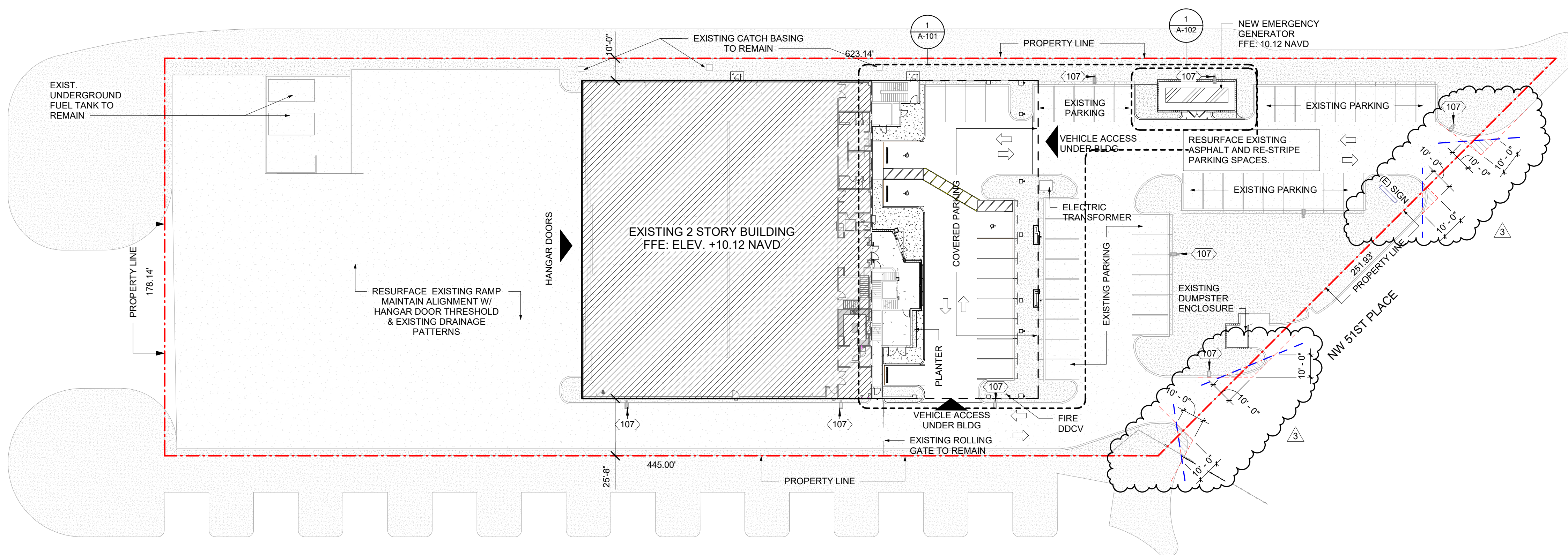

LOCATION MAP

NOT TO SCALE

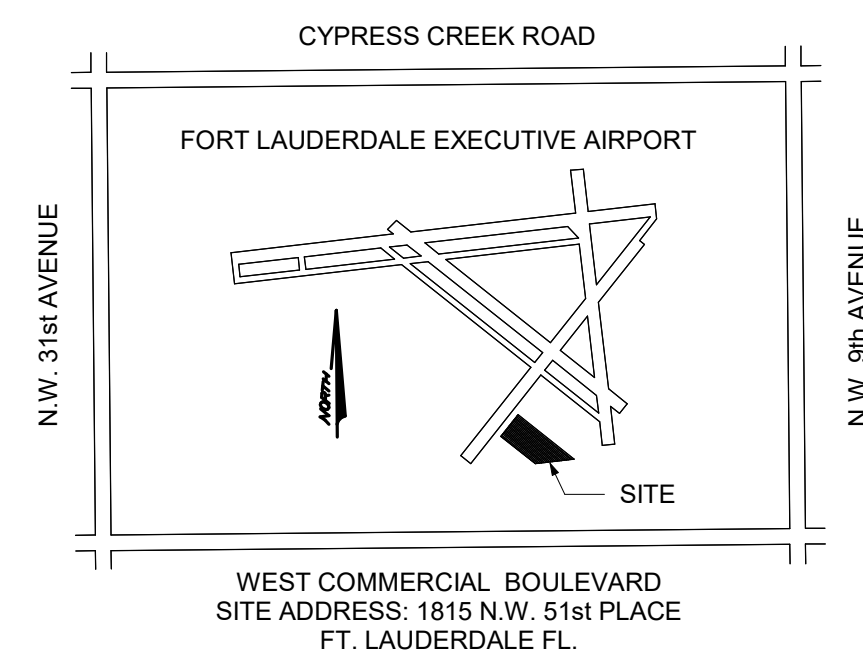

DESIGNED	DRAWN	CHECKED
Designer	Author	Checker

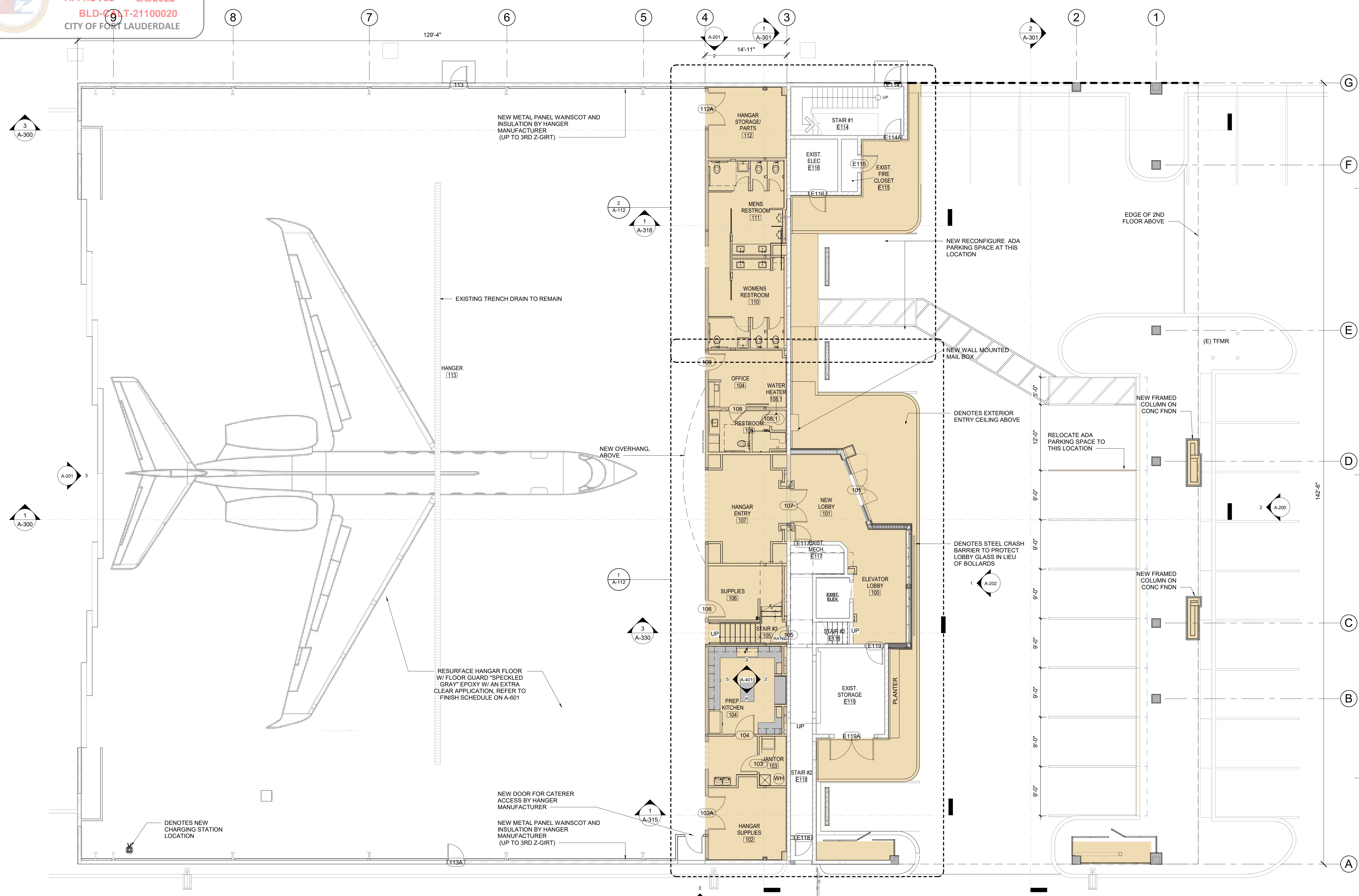

1 FIRST FLOOR PLAN
 1/8" = 1'-0"

LEGEND

	= DENOTES EXTENT OF SCOPE OF WORK
	= NEW WALL/INFILL

REVISIONS

DATE:	COMM:
10.04.21	21025

**WeatherTech-
 HANGER
 RENOVATION**

1815 NW 51st PL FORT LAUDERDALE, FL 33309

Digitally signed
 by W. Douglas
 Snyder
 Date:
 2021.10.18
 15:08:41-04'00'

LEVEL 01- OVERALL FLOOR PLAN

PERMIT SET

A-110

DESIGNED	DRAWN	CHECKED
Designer	Author	Checker

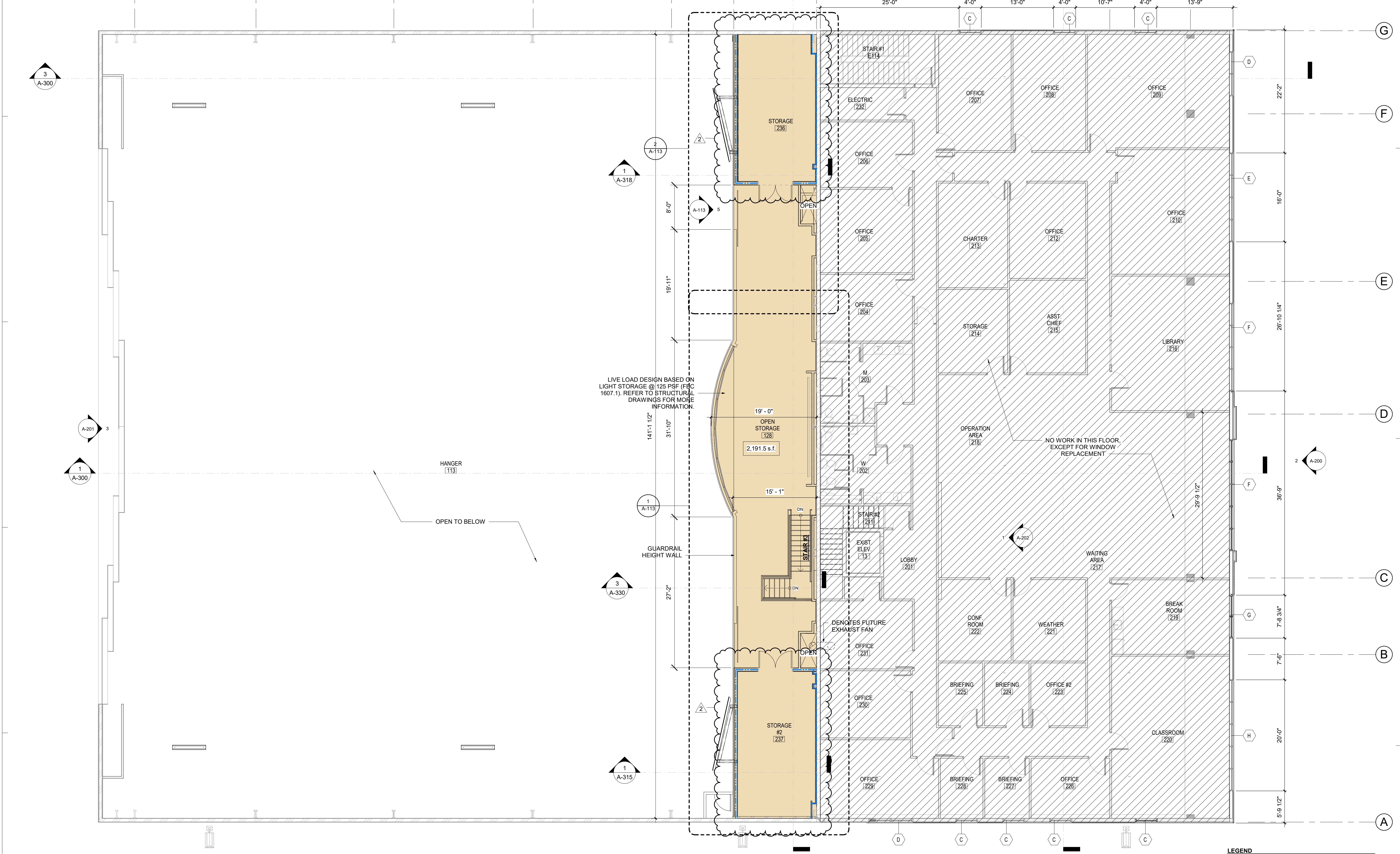

2	REV 02- PERMIT COMMENTS	02.30.22
---	-------------------------	----------

REVISIONS	
DATE:	COMM:
10.04.21	21025

**WeatherTech-
 HANGER
 RENOVATION**

1815 NW 51st PL FORT LAUDERDALE, FL 33309

Digitally signed
 by W. Douglas
 Snyder
 Date:
 2022.03.04
 14:31:43-05'00'

LEVEL 02- OVERALL FLOOR PLAN

PERMIT SET

A-111

1 LEVEL 02- OVERALL FLOOR PLAN
 1/8" = 1'-0"

3/4/2022 10:16:51 AM











**BOUNDARY SURVEY OF
A PORTION OF F B O AREA NO. 2 SECTION B
(PORTION TRACT I F-X-E PLAT)**

LEGAL DESCRIPTION PARCEL 2-A
A parcel of land that is a portion of Tract 1, "F-X-E PLAT" according to the plat thereof, as recorded in Plat Book 119 at Page 4 of the Public Records of Broward County, Florida. Said land also being a portion of the Northwest one-quarter (NW 1/4) of Section 16, Township 49 South, Range 42 East, in the City of Fort Lauderdale and in Fort Lauderdale Executive Airport, Broward County, Florida, more particularly located and described as follows:
Commence at the Southwest corner of said Northwest one-quarter (NW 1/4) of Section 16; thence 350.00 feet N 01° 28' 27" W on the West line of said Northwest one-quarter (NW 1/4); thence 133.56 feet N 88° 34' 53" E parallel with the south line of said Northwest one-quarter (NW 1/4) of section 16 to intersect a line that is parallel with and 90.00 feet southeasterly as measured at right angles from the centerline of Taxiway "Charlie" (formerly the NE-SW runway); thence 858.22 feet N 38° 46' 23" E on said parallel line; thence 5.00 feet S 51° 13' 37" E to the POINT OF BEGINNING; thence continue 445.00 feet S 51° 13' 37" E; thence 251.93 feet N 83° 46' 23" E to intersect a line that is parallel with and 825.96 feet southeasterly as measured at right angles from the centerline of Taxiway "Bravo"; thence 623.14 feet N 51° 13' 37" W on said parallel line to intersect a line that is parallel with and 95.00 feet southeasterly as measured at right angles from the centerline of Taxiway "Charlie"; thence 178.14 feet S 38° 46' 23" W to the POINT OF BEGINNING, containing 95,140 square feet, more or less (2.184 acres); restricting building heights to avoid obstructions to navigation as required by CRF 14, Subchapter "E" (Airspace), Part 77.

SURVEY NOTES

The NFIP Flood Map has designated the herein described lands to be situated in Zone X Community No. 125105 Panel 0208 Suffix F Base Flood Elevation N/A Dated 8-18-92
This Survey reflects matters from Title Commitment File No. 1062-1452056, COMMITMENT DATE: 1-11-2007 @ 8:00 A.M. by FIRST AMERICAN TITLE INSURANCE COMPANY
Reference Bench Mark is per Broward County benchmark No. 1867.
NOTE: Elevations shown are prefixed with a + sign and refer to North American Vertical Datum of 1988. These elevations have been converted from National Geodetic Vertical Datum of 1929 using the U.S. Army Corps of Engineers "Corpscon" program version 6.01
Bearings indicated herein are based on an assumed value of S.88°34'58"W, being the SOUTH LINE OF S.W. 1/4 SEC. 16-49-42

Description as indicated hereon furnished by Client. This survey is prepared for the sole and exclusive use of the parties as surveyed for and as certified to and shall not be relied upon by any other entity or individual.
Public access provided by lease agreement recorded in o.r.b. 23172 pg.0046

ITEM NUMBERS APPLICABLE AND NON-APPLICABLE AFFECTING PROPERTY PER CHAIN OF TITLE FILE NUMBER 1062-1452056, DATED 1-11-07
1 THRU 8. APPLY - BLANKET IN NATURE - NON-PLOTTABLE
9. APPLIES - BLANKET IN NATURE - NON-PLOTTABLE, (O.R. 1370-351 SHOWN)
10. THRU 12. APPLY - BLANKET IN NATURE - NON-PLOTTABLE

DRAINAGE AS-BUILT		
S-1 NYLOPLAST INLINE DRAIN 12" STANDARD GRATE RIM +7.55 - +7.66 INV. +2.10 - +2.10		S-20 DRAINAGE STRUCTURE (TYPE UNKNOWN) TYPE C FRAME & GRATE RIM +6.16 - +8.18 INV. S.W. +0.91 - +0.79
S-2 DRAINAGE STRUCTURE (TYPE UNKNOWN) TYPE C FRAME & GRATE RIM +7.06 - +7.68 INV. N.W. +0.91 - +0.82 INV. S.W. +2.00 - +1.90		S-21 DRAINAGE STRUCTURE (TYPE UNKNOWN) TYPE C FRAME & GRATE RIM +6.06 - +8.01 INV. N.E. +0.91 - +0.91 INV. S.E. +0.91 - +0.95
S-3 JUNCTION MANHOLE RIM +6.52 - +8.54 INV. S.W. +0.91 - +0.92 INV. S.E. +0.91 - +0.89		S-22 DRAINAGE STRUCTURE (TYPE UNKNOWN) TYPE C FRAME & GRATE RIM +6.06 - +8.27 INV. N.W. +0.91 - +0.86 INV. S.E. +0.91 - +0.97
S-10 DRAINAGE STRUCTURE (TYPE UNKNOWN) TYPE C FRAME & GRATE RIM +6.95 - +8.95 INV. +0.91 - +0.80		YD1 NYLOPLAST INLINE DRAIN (2712AGBN) 12" STANDARD GRATE (NOT VERIFIED) RIM +6.00 - +8.62 INV. S.E. +4.30 - +5.12
S-11 DRAINAGE STRUCTURE NOT CONSTRUCTED		YD2 NYLOPLAST INLINE DRAIN (2712AGBN) 12" STANDARD GRATE (NOT VERIFIED) RIM +6.00 - +8.59 INV. N.W. +4.15 - +5.06 INV. S.E. +4.15 - +5.06
S-12 DRAINAGE STRUCTURE (TYPE UNKNOWN) TYPE C FRAME & GRATE RIM +6.30 - +8.67 INV. N.W. +0.91 - +0.72 INV. N.E. +0.91 - +1.04 INV. S.E. +0.91 - +0.90		YD3 NYLOPLAST INLINE DRAIN (2712AGBN) 12" STANDARD GRATE (NOT VERIFIED) RIM +6.00 - +8.53 INV. N.W. +4.00 - +5.10 INV. S.E. +4.00 - +5.10
S-13 CONTROL STRUCTURE RIM +7.89 - +7.91 INV. N.W. +0.91 - +0.90 INV. N.E. +0.91 - +0.86 INV. S. +0.91 - +1.58 (C/L-0.13)		

ASPHALT ELEVATIONS:

ELEV. LOCATION
+8.51 = AS BUILT
+8.45 = PROPOSED

ELEV. LOCATION
+8.51 = ADDITIONAL ELEVATIONS
+8.51 = EXISTING ELEVATIONS

CERTIFIED TO:
ROSS SOUTHERN PROPERTIES, LLC
P.F.T., INC., D/B/A/ PROFESSIONAL FLIGHT TRAINING
CITY OF FORT LAUDERDALE

NOTE: SITE PLAN INFORMATION OBTAINED FROM DEGIROLMO AND ASSOCIATES, INC., D&A JOB NO. 04-0024, DATED 7-31-06

NOTE: PROPOSED ELEVATION INFORMATION OBTAINED FROM DEGIROLMO AND ASSOCIATES, INC., D&A JOB NO. 04-0024, SHEET PGD-1, DATED 3-10-08

NOTE: NOT VALID WITHOUT THE SIGNATURE AND THE ORIGINAL RAISED SEAL OF A FLORIDA LICENSED SURVEYOR AND MAPPER.

WINNINGHAM & FRADLEY, INC.
ENGINEERS-PLANNERS-SURVEYORS
111 N.E. 44th STREET, OAKLAND PARK, FL 33334
954-771-7440 FAX: 954-771-0298

DATE: 6-21-01	#LB2995
REVISED SURVEY 2-02-07	STAKE SPOT FINAL
SCALE: 1"=30'	SKETCH NO.: 3 1 4 9 5

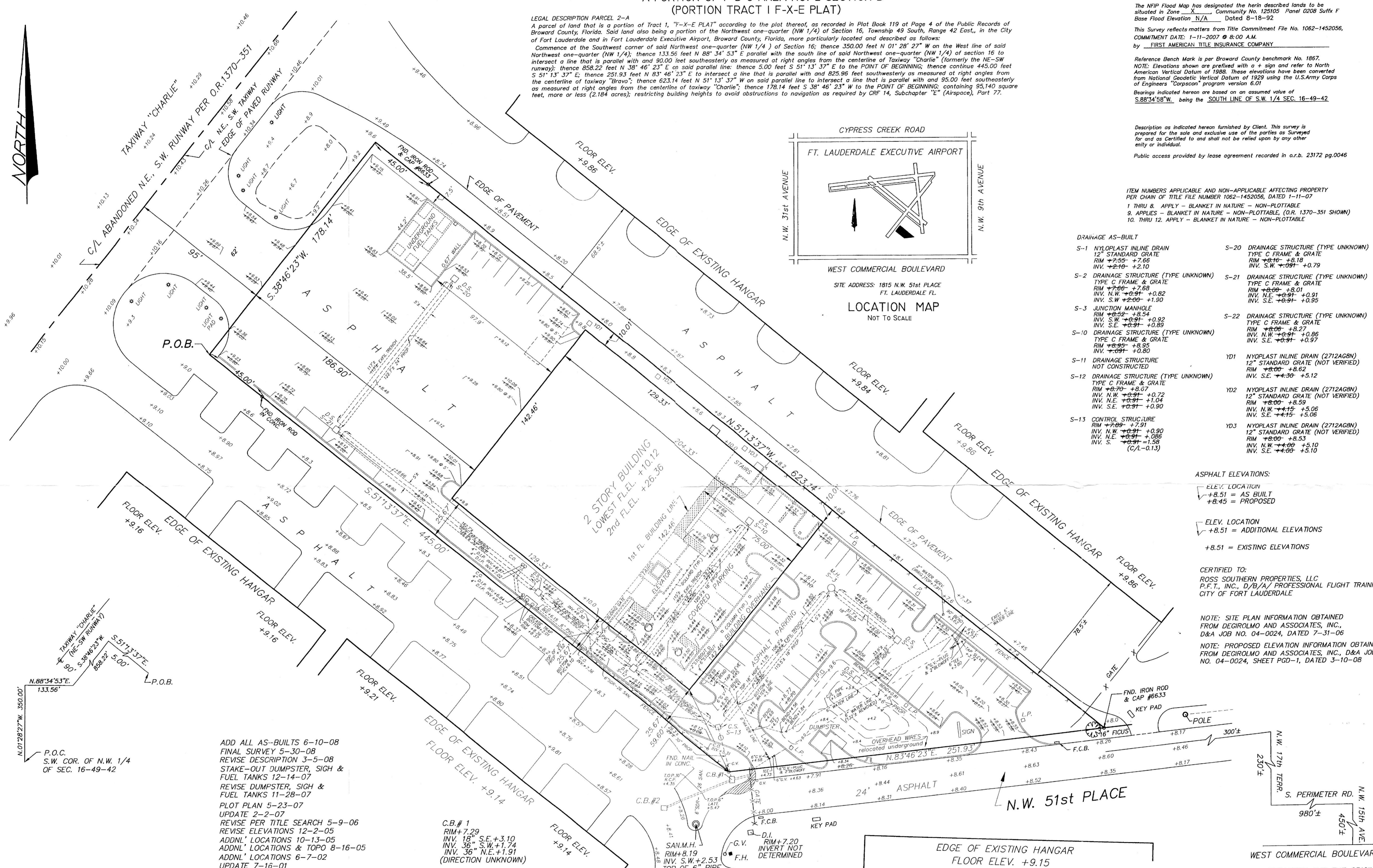
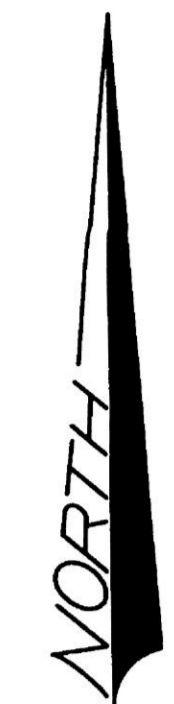
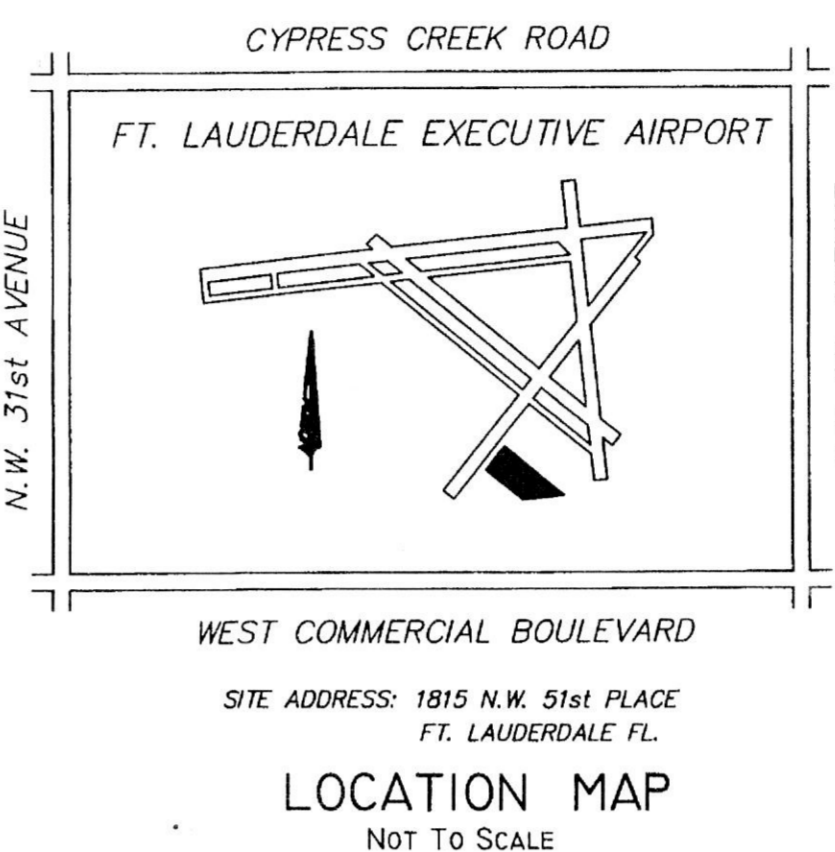

ADD ALL AS-BUILTS 6-10-08
FINAL SURVEY 5-30-08
REVISE DESCRIPTION 3-5-08
STAKE-OUT DUMPSTER, SIGH & FUEL TANKS 12-14-07
REVISE DUMPSTER, SIGH & FUEL TANKS 11-28-07
PLOT PLAN 5-23-07
UPDATE 2-2-07
REVISE PER TITLE SEARCH 5-9-06
REVISE ELEVATIONS 12-2-05
ADDNL' LOCATIONS 10-13-05
ADDNL' LOCATIONS & TOPO 8-16-05
ADDNL' LOCATIONS 6-7-02
UPDATE 7-16-01

NOTE: AS-BUILT INFORMATION OBTAINED FROM FIELD WORK AND FROM DEGIROLMO AND ASSOCIATES, INC., JOB NO. 04-0024 DATED 7-31-06, SHEETS PGD-1 (7-19-06) AND WS-1 (7-31-06)

C.B.# 1
RIM+7.29
INV. 18" S.E.+3.10
INV. 36" S.W.+1.74
INV. 36" N.E.+1.91
INV. 36" S.E.+1.51
(DIRECTION UNKNOWN)

C.B.# 2
RIM+8.48
INV. 32" N.E.+1.66
INV. 36" S.E.+1.51

STORM M.H.
RIM+8.44
INV. 36" N.+0.60
INV. 48" S.+1.06

SAN. M.H.
RIM+8.43
INV. N.+1.61
INV. E.+1.63
INV. W.+1.56

SURVEY ABBREVIATIONS

A = ARC DISTANCE	C.L.F. = CHAIN LINK FENCE	GAR. = GARAGE	(R) = RADIAL LINE TO CURVE
A/C = AIR CONDITION UNIT	D = DELTA (CENTRAL ANGLE)	I.R. = IRON ROD	RES. = RESIDENCE
ASPH. = ASPHALT	D.E. = DRAINAGE EASEMENT	L.E. = LANDSCAPE EASEMENT	R/W = RIGHT OF WAY
BLDG. = BUILDING	E.O.W. = EDGE OF WATER	N/D = NAIL & DISC	STY = STORY
B.M. = BENCH MARK	F.C.B. = FT LAUDERDALE COMMUNICATION BOX	● = REBAR SET #LB2995	S/W = SIDEWALK
C.B. = CATCH BASIN	F.H. = FIRE HYDRANT	● = REBAR FND.#LB6680	T.O.B. = TOP OF BANK
COMM. = COMMUNICATIONS	FL.E.L. = FLOOR ELEVATION	P.O.B. = POINT OF BEGINNING	U.E. = UTILITY EASEMENT
C.S. = CONTROL STRUCTURE		P.O.C. = POINT OF COMMENCEMENT	W.M. = WATER METER

BY: *Mark D. Sturgis* 6-10-08
MARK D. STURGIS
PROFESSIONAL SURVEYOR AND MAPPER No. 4829
STATE OF FLORIDA
FIELD BOOK No: 620-75; 840-22; 1127-67-73