

Solicitation 12493-512

Fence, Chain Link and Picket, Annual Contract

Bid Designation: Public



City of Fort Lauderdale

Bid 12493-512

Fence, Chain Link and Picket, Annual Contract

Bid Number **12493-512**
 Bid Title **Fence, Chain Link and Picket, Annual Contract**

Bid Start Date **Feb 12, 2021 4:13:24 PM EST**
 Bid End Date **Mar 4, 2021 2:00:00 PM EST**
 Question &
 Answer End Date **Feb 25, 2021 5:00:00 PM EST**

Bid Contact **AnnDebra Diaz, CPPB**
Procurement Administrator
Procurement
954-828-5949
adiaz@fortlauderdale.gov

Contract Duration **1 year**
 Contract Renewal **3 annual renewals**
 Prices Good for **120 days**

Bid Comments **The City of Fort Lauderdale, Florida (City) is seeking bids from qualified bidders, hereinafter referred to as the Contractor, to provide fence installation and repair for the City, in accordance with the terms, conditions, and specifications contained in this Invitation To Bid (ITB).**

For further information, go to www.bidsync.com

Item Response Form

Item **12493-512--01-01 - Removal / Disposal of Fence**
 Quantity **1 linear foot**
 Unit Price
 Delivery Location **City of Fort Lauderdale**
See ITB Specifications
 See ITB Specifications
 Fort Lauderdale FL 33301
Qty 1

Description

Provide price per linear foot to furnish all materials, labor, and equipment to remove (off of project site) and properly dispose of all types and heights of chain link or picket fence, posts, gates, and associated hardware.
 Prior annual quantities estimated at 1,650 linear feet. Prior quantities are not indicative of future use.

Item **12493-512--01-02 - Installation of 6' High Temporary Construction Fence**

Quantity **1 linear foot**
 Unit Price
 Delivery Location **City of Fort Lauderdale**
[See ITB Specifications](#)
 See ITB Specifications
 Fort Lauderdale FL 33301
Qty 1

Description

Provide price per linear foot to furnish all materials, labor, and equipment to install 6' temporary construction fence.

Prior annual quantities estimated at 400 linear feet. Prior quantities are not indicative of future use.

Item **12493-512--01-03 - 4' High Chain Link Fence, Galvanized**
 Quantity **1 linear foot**
 Unit Price
 Delivery Location **City of Fort Lauderdale**
[See ITB Specifications](#)
 See ITB Specifications
 Fort Lauderdale FL 33301
Qty 1

Description

Provide price per linear foot to furnish all materials, labor, and/or equipment, including clear and grubbing, to install 4' high Galvanized (g) chain link fence. This includes all associated Galvanized posts (end, tension, or terminal), fence fabric (9-gauge steel), and hardware.

Prior annual quantities estimated at 200 linear feet. Prior quantities are not indicative of future use.

Item **12493-512--01-04 - 6' High Chain Link Fence, Galvanized**
 Quantity **1 linear foot**
 Unit Price
 Delivery Location **City of Fort Lauderdale**
[See ITB Specifications](#)
 See ITB Specifications
 Fort Lauderdale FL 33301
Qty 1

Description

Provide price per linear foot to furnish all materials, labor, and/or equipment, including clear and grubbing, to install 6' high Galvanized (g) chain link fence. This includes all associated Galvanized posts (end, tension, or terminal), fence fabric (9-gauge steel), and hardware.

Prior annual quantities estimated at 1,600 linear feet. Prior quantities are not indicative of future use.

Item **12493-512--01-05 - 8' High Chain Link Fence, Galvanized**
 Quantity **1 linear foot**
 Unit Price
 Delivery Location **City of Fort Lauderdale**
[See ITB Specifications](#)
 See ITB Specifications
 Fort Lauderdale FL 33301
Qty 1

Description

Provide price per linear foot to furnish all materials, labor, and/or equipment, including clear and grubbing, to install 8' high Galvanized (g)chain link fence. This includes all associated Galvanized post (end, tension, or terminal), fence fabric (9-gauge steel), and hardware.

Prior annual quantities estimated at 300 linear feet. Prior quantities are not indicative of future use.

Item **12493-512--01-06 - 10' High Chain Link Fence, Galvanized**

Quantity **1 linear foot**

Unit Price

Delivery Location **City of Fort Lauderdale**
[See ITB Specifications](#)
 See ITB Specifications
 Fort Lauderdale FL 33301
Qty 1

Description

Provide price per linear foot to furnish all materials, labor, and/or equipment, including clear and grubbing, to install 10' high Galvanized (g)chain link fence. This includes all associated Galvanized posts (end, tension, or terminal), fence fabric (9-gauge steel), and hardware.

Prior annual quantities estimated at 350 linear feet. Prior quantities are not indicative of future use.

Item **12493-512--01-07 - 12' High Chain Link Fence, Galvanized**

Quantity **1 linear foot**

Unit Price

Delivery Location **City of Fort Lauderdale**
[See ITB Specifications](#)
 See ITB Specifications
 Fort Lauderdale FL 33301
Qty 1

Description

Provide price per linear foot to furnish all materials, labor, and/or equipment, including clear and grubbing, to install 12' high Galvanized (g) chain link fence. This includes all associated Galvanized posts (end, tension, or terminal), fence fabric (9-gauge steel), and hardware.

Prior annual quantities estimated at 100 linear feet. Prior quantities are not indicative of future use.

Item **12493-512--01-08 - 20' High Chain Link Fence, Galvanized**

Quantity **1 linear foot**

Unit Price

Delivery Location **City of Fort Lauderdale**
[See ITB Specifications](#)
 See ITB Specifications
 Fort Lauderdale FL 33301
Qty 1

Description

Provide price per linear foot to furnish all materials, labor, and/or equipment, including clear and grubbing, to install 20' high Galvanized (g) chain link fence. This includes all associated Galvanized posts (end, tension, or terminal), fence fabric (9-gauge steel), and hardware.

Prior annual quantities estimated at 100 linear feet. Prior quantities are not indicative of future use.

Item **12493-512--01-09 - 4' High Chain Link Fence, PVC Coated**

Quantity **1 linear foot**

Unit Price

Delivery Location **City of Fort Lauderdale**
[See ITB Specifications](#)
 See ITB Specifications
 Fort Lauderdale FL 33301
Qty 1

Description

Provide price per linear foot to furnish all materials, labor, and/or equipment, including clear and grubbing, to install 4'high of PVC Coated chain link fence. This includes all associated PVC Coated posts (end, tension, or terminal), fence fabric (9-gauge steel), and hardware.

Prior annual quantities estimated at 400 linear feet. Prior quantities are not indicative of future use.

Item **12493-512--01-10 - 6' High Chain Link Fence, PVC Coated**

Quantity **1 linear foot**

Unit Price

Delivery Location **City of Fort Lauderdale**
[See ITB Specifications](#)
 See ITB Specifications
 Fort Lauderdale FL 33301
Qty 1

Description

Provide price per linear foot to furnish all materials, labor, and/or equipment, including clear and grubbing, to install 6' high PVC coated (c) chain link fence. This includes all associated PVC coated posts (end, tension, or terminal), fence fabric (9-gauge steel), and hardware.

Prior annual quantities estimated at 1200 linear feet. Prior quantities are not indicative of future use.

Item **12493-512--01-11 - 8' High Chain Link Fence, PVC Coated**

Quantity **1 linear foot**

Unit Price

Delivery Location **City of Fort Lauderdale**
[See ITB Specifications](#)
 See ITB Specifications
 Fort Lauderdale FL 33301
Qty 1

Description

Provide price per linear foot to furnish all materials, labor, and/or equipment, including clear and grubbing, to install 8' high PVC coated (c) chain link fence. This includes all associated PVC coated posts (end, tension, or terminal), fence fabric (9-gauge steel), and hardware.

Prior annual quantities estimated at 300 linear feet. Prior quantities are not indicative of future use.

Item **12493-512--01-12 - 10' High Chain Link Fence, PVC Coated**

Quantity **1 linear foot**

Unit Price

Delivery Location **City of Fort Lauderdale**
[See ITB Specifications](#)
 See ITB Specifications
 Fort Lauderdale FL 33301
Qty 1

Description

Provide price per linear foot to furnish all materials, labor, and/or equipment, including clear and grubbing, to install the following heights 10' high

PVC coated (c) chain link fence. This includes all associated PVC coated posts (end, tension, or terminal), fence fabric (9-gauge steel), and hardware.

Prior annual quantities estimated at 300 linear feet. Prior quantities are not indicative of future use.

Item **12493-512--01-13 - 20' High Chain Link Fence, PVC Coated**

Quantity **1 linear foot**

Unit Price

Delivery Location **City of Fort Lauderdale**
[See ITB Specifications](#)
 See ITB Specifications
 Fort Lauderdale FL 33301
Qty 1

Description

Provide price per linear foot to furnish all materials, labor, and/or equipment, including clear and grubbing, to install 20' high PVC coated (c) chain link fence. This includes all associated PVC coated posts (end, tension, or terminal), fence fabric (9-gauge steel), and hardware.

Prior annual quantities estimated at 200 linear feet. Prior quantities are not indicative of future use.

Item **12493-512--01-14 - 30' High Chain Link Fence, PVC Coated**

Quantity **1 linear foot**

Unit Price

Delivery Location **City of Fort Lauderdale**
[See ITB Specifications](#)
 See ITB Specifications
 Fort Lauderdale FL 33301
Qty 1

Description

Provide price per linear foot to furnish all materials, labor, and/or equipment, including clear and grubbing, to install 30' high PVC coated (c) chain link fence. This includes all associated PVC coated posts (end, tension, or terminal), fence fabric (9-gauge steel), and hardware.

Prior annual quantities estimated at 300 linear feet. Prior quantities are not indicative of future use.

Item **12493-512--01-15 - 6'H x (6' to 10') Wide Gate, Galvanized, Single Rolling**

Quantity **1 each**

Unit Price

Delivery Location **City of Fort Lauderdale**
[See ITB Specifications](#)
 See ITB Specifications
 Fort Lauderdale FL 33301
Qty 1

Description

Single rolling gate w/ 4" gate posts (Galvanized) Furnish all materials, labor, and/or equipment, to install single side rolling gates to Galvanized chain link fence. This includes all associated gate posts, fence fabric (9-gauge steel), and hardware.

NOTE: The quantity as indicated is for City calculation purposes. The City shall purchase as many of these as required throughout the contract term.

Item **12493-512--01-16 - 6'H x (11' to 20')Wide Gate, Galvanized, Single Rolling**

Quantity **1 each**

Unit Price

Delivery Location **City of Fort Lauderdale**
[See ITB Specifications](#)
 See ITB Specifications
 Fort Lauderdale FL 33301
Qty 1

Description

Single rolling gate w/ 4" gate posts (Galvanized) Furnish all materials, labor, and/or equipment, to install single side rolling gates to Galvanized chain link fence. This includes all associated Galvanized and PVC coated gate posts, fence fabric (9-gauge steel), and hardware.
 NOTE: The quantity as indicated is for City calculation purposes. The City shall purchase as many of these as required throughout the contract term.

Item **12493-512--01-17 - 8'H x (6' to 10')Wide Gate, Galvanized, Single Rolling**

Quantity **1 each**

Unit Price

Delivery Location **City of Fort Lauderdale**
[See ITB Specifications](#)
 See ITB Specifications
 Fort Lauderdale FL 33301
Qty 1

Description

Single rolling gate w/ 4" gate posts (Galvanized) Furnish all materials, labor, and/or equipment, to install single side rolling gates to Galvanized chain link fence. This includes all associated Galvanized and PVC coated gate posts, fence fabric (9-gauge steel), and hardware.
 NOTE: The quantity as indicated is for City calculation purposes. The City shall purchase as many of these as required throughout the contract term.

Item **12493-512--01-18 - 8'H x (11' to 20')Wide Gate, Galvanized, Single Rolling**

Quantity **1 each**

Unit Price

Delivery Location **City of Fort Lauderdale**
[See ITB Specifications](#)
 See ITB Specifications
 Fort Lauderdale FL 33301
Qty 1

Description

Single rolling gate w/ 4" gate posts (Galvanized) Furnish all materials, labor, and/or equipment, to install single side rolling gates to Galvanized chain link fence. This includes all associated Galvanized gate posts, fence fabric (9-gauge steel), and hardware.
 NOTE: The quantity as indicated is for City calculation purposes. The City shall purchase as many of these as required throughout the contract term.

Item **12493-512--01-19 - 6'H x (11' to 20')Wide Gate, PVC Coated, Single Rolling**

Quantity **1 each**

Unit Price

Delivery Location **City of Fort Lauderdale**
[See ITB Specifications](#)
 See ITB Specifications
 Fort Lauderdale FL 33301
Qty 1

Description

Single rolling gate w/ 4" gate posts (PVC coated) Furnish all materials, labor, and/or equipment, to install single side rolling gates to PVC coated

chain link fence. This includes all associated PVC coated gate posts, fence fabric (9-gauge steel), and hardware.

NOTE: The quantity as indicated is for City calculation purposes. The City shall purchase as many of these as required throughout the contract term.

Item **12493-512--01-20 - 8'H x (11' to 20')Wide Gate, PVC Coated, Single Rolling**

Quantity **1 each**

Unit Price

Delivery Location **City of Fort Lauderdale**

[See ITB Specifications](#)

See ITB Specifications

Fort Lauderdale FL 33301

Qty 1

Description

Single rolling gate w/ 4" gate posts (PVC coated) Furnish all materials, labor, and/or equipment, to install single side rolling gates to PVC coated (c) chain link fence. This includes all associated PVC coated gate posts, fence fabric (9-gauge steel), and hardware.

NOTE: The quantity as indicated is for City calculation purposes. The City shall purchase as many of these as required throughout the contract term.

Item **12493-512--01-21 - 4'H x 5'W Gate, Galvanized, Single Swing**

Quantity **1 each**

Unit Price

Delivery Location **City of Fort Lauderdale**

[See ITB Specifications](#)

See ITB Specifications

Fort Lauderdale FL 33301

Qty 1

Description

Single swing gate w/ 3" gate posts (Galvanized) Furnish all materials, labor, and/or equipment, to install single swing gates to Galvanized chain link fence. This includes all associated Galvanized gate posts, fence fabric (9-gauge steel), and hardware. NOTE: The quantity as indicated is for City calculation purposes. The City shall purchase as many of these as required throughout the contract term.

Item **12493-512--01-22 - 6'H x 5'W Gate, Galvanized, Single Swing**

Quantity **1 each**

Unit Price

Delivery Location **City of Fort Lauderdale**

[See ITB Specifications](#)

See ITB Specifications

Fort Lauderdale FL 33301

Qty 1

Description

Single swing gate w/ 3" gate posts (Galvanized) Furnish all materials, labor, and/or equipment, to install single swing gates to Galvanized chain link fence. This includes all associated Galvanized gate post, fence fabric (9-gauge steel), and hardware. NOTE: The quantity as indicated is for City calculation purposes. The City shall purchase as many of these as required throughout the contract term.

Item **12493-512--01-23 - 6'H x (6' to 10')Wide Gate, Galvanized, Single Swing**

Quantity **1 each**

Unit Price

Delivery Location **City of Fort Lauderdale**

[See ITB Specifications](#)
 See ITB Specifications
 Fort Lauderdale FL 33301
Qty 1

Description

Single swing gate w/ 4" gate posts (Galvanized) Furnish all materials, labor, and/or equipment, to install single swing gates to Galvanized chain link fence. This includes all associated Galvanized gate posts, fence fabric (9-gauge steel), and hardware. NOTE: The quantity as indicated is for City calculation purposes. The City shall purchase as many of these as required throughout the contract term.

Item **12493-512-01-24 - 8'H x 5'W Gate, Galvanized, Single Swing**

Quantity **1 each**

Unit Price

Delivery Location **City of Fort Lauderdale**

[See ITB Specifications](#)
 See ITB Specifications
 Fort Lauderdale FL 33301
Qty 1

Description

Single swing gate w/ 3" gate posts (Galvanized) Furnish all materials, labor, and/or equipment, to install single swing gates to Galvanized chain link fence. This includes all associated Galvanized gate posts, fence fabric (9-gauge steel), and hardware. NOTE: The quantity as indicated is for City calculation purposes. The City shall purchase as many of these as required throughout the contract term.

Item **12493-512-01-25 - 8'H x (6' to 10')Wide Gate, Galvanized, Single Swing**

Quantity **1 each**

Unit Price

Delivery Location **City of Fort Lauderdale**

[See ITB Specifications](#)
 See ITB Specifications
 Fort Lauderdale FL 33301
Qty 1

Description

Single swing gate w/ 4" gate posts (Galvanized) Furnish all materials, labor, and/or equipment, to install single swing gates to Galvanized chain link fence. This includes all associated Galvanized gate posts, fence fabric (9-gauge steel), and hardware. NOTE: The quantity as indicated is for City calculation purposes. The City shall purchase as many of these as required throughout the contract term.

Item **12493-512-01-26 - 10'H x 5'W Gate, Galvanized, Single Swing**

Quantity **1 each**

Unit Price

Delivery Location **City of Fort Lauderdale**

[See ITB Specifications](#)
 See ITB Specifications
 Fort Lauderdale FL 33301
Qty 1

Description

Single swing gate w/ 3" gate posts (Galvanized) Furnish all materials, labor, and/or equipment, to install single swing gates to Galvanized chain link fence. This includes all associated Galvanized gate posts, fence fabric (9-gauge steel), and hardware. NOTE: The quantity as indicated is for City calculation purposes. The City shall purchase as many of these as required throughout the contract term.

Item **12493-512-01-27 - 10'H x (6' to 10')Wide Gate, Galvanized, Single Swing**

Quantity **1 each**
 Unit Price
 Delivery Location **City of Fort Lauderdale**
[See ITB Specifications](#)
 See ITB Specifications
 Fort Lauderdale FL 33301
Qty 1

Description

Single swing gate w/ 4" gate posts (Galvanized) Furnish all materials, labor, and/or equipment, to install single swing gates to Galvanized chain link fence. This includes all associated Galvanized gate posts, fence fabric (9-gauge steel), and hardware. NOTE: The quantity as indicated is for City calculation purposes. The City shall purchase as many of these as required throughout the contract term.

Item **12493-512--01-28 - 4'H x 5'W Gate, PVC Coated, Single Swing**
 Quantity **1 each**
 Unit Price
 Delivery Location **City of Fort Lauderdale**
[See ITB Specifications](#)
 See ITB Specifications
 Fort Lauderdale FL 33301
Qty 1

Description

Single swing gate w/ 3" gate posts (PVC coated) Furnish all materials, labor, and/or equipment, to install single swing gates to PVC coated chain link fence. This includes all associated PVC coated gate posts, fence fabric (9-gauge steel), and hardware. NOTE: The quantity as indicated is for City calculation purposes. The City shall purchase as many of these as required throughout the contract term.

Item **12493-512--01-29 - 6'H x 5'W Gate, PVC Coated, Single Swing**
 Quantity **1 each**
 Unit Price
 Delivery Location **City of Fort Lauderdale**
[See ITB Specifications](#)
 See ITB Specifications
 Fort Lauderdale FL 33301
Qty 1

Description

Single swing gate w/ 3" gate posts (PVC coated) Furnish all materials, labor, and/or equipment, to install single swing gates to PVC coated chain link fence. This includes all associated PVC coated gate posts, fence fabric (9-gauge steel), and hardware. NOTE: The quantity as indicated is for City calculation purposes. The City shall purchase as many of these as required throughout the contract term.

Item **12493-512--01-30 - 6'H x (6' to 10')Wide Gate, PVC Coated, Single Swing**
 Quantity **1 each**
 Unit Price
 Delivery Location **City of Fort Lauderdale**
[See ITB Specifications](#)
 See ITB Specifications
 Fort Lauderdale FL 33301
Qty 1

Description

Single swing gate w/ 4" gate posts (PVC coated) Furnish all materials, labor, and/or equipment, to install single swing gates to PVC coated

chain link fence. This includes all associated PVC coated gate posts, fence fabric (9-gauge steel), and hardware. NOTE: The quantity as indicated is for City calculation purposes. The City shall purchase as many of these as required throughout the contract term.

Item **12493-512--01-31 - 8'H x 5'W Gate, PVC Coated, Single Swing**

Quantity **1 each**

Unit Price

Delivery Location **City of Fort Lauderdale**
[See ITB Specifications](#)
 See ITB Specifications
 Fort Lauderdale FL 33301
Qty 1

Description

Single swing gate w/ 3" gate posts (PVC coated) Furnish all materials, labor, and/or equipment, to install single swing gates to PVC coated chain link fence. This includes all associated PVC coated gate posts, fence fabric (9-gauge steel), and hardware. NOTE: The quantity as indicated is for City calculation purposes. The City shall purchase as many of these as required throughout the contract term.

Item **12493-512--01-32 - 8'H x (6' to 10')Wide Gate, PVC Coated, Single Swing**

Quantity **1 each**

Unit Price

Delivery Location **City of Fort Lauderdale**
[See ITB Specifications](#)
 See ITB Specifications
 Fort Lauderdale FL 33301
Qty 1

Description

Single swing gate w/ 4" gate posts (PVC coated) Furnish all materials, labor, and/or equipment, to install single swing gates to PVC coated chain link fence. This includes all associated PVC coated gate posts, fence fabric (9-gauge steel), and hardware. NOTE: The quantity as indicated is for City calculation purposes. The City shall purchase as many of these as required throughout the contract term.

Item **12493-512--01-33 - 10'H x 5'W Gate, PVC Coated, Single Swing**

Quantity **1 each**

Unit Price

Delivery Location **City of Fort Lauderdale**
[See ITB Specifications](#)
 See ITB Specifications
 Fort Lauderdale FL 33301
Qty 1

Description

Single swing gate w/ 3" gate posts (PVC coated) Furnish all materials, labor, and/or equipment, to install single swing gates to PVC coated chain link fence. This includes all associated PVC coated gate posts, fence fabric (9-gauge steel), and hardware. NOTE: The quantity as indicated is for City calculation purposes. The City shall purchase as many of these as required throughout the contract term.

Item **12493-512--01-34 - 10'H x (6' to 10')Wide Gate, PVC Coated, Single Swing**

Quantity **1 each**

Unit Price

Delivery Location **City of Fort Lauderdale**
[See ITB Specifications](#)

See ITB Specifications
Fort Lauderdale FL 33301

Qty 1

Description

Single swing gate w/ 4" gate posts (PVC coated) Furnish all materials, labor, and/or equipment, to install single swing gates to PVC coated chain link fence. This includes all associated PVC coated gate posts, fence fabric (9-gauge steel), and hardware. NOTE: The quantity as indicated is for City calculation purposes. The City shall purchase as many of these as required throughout the contract term.

Item **12493-512--01-35 - 6'H x (6' to 10')W Gate, Galvanized, Double Leaf Swing**

Quantity **1 each**

Unit Price

Delivery Location **City of Fort Lauderdale**

[See ITB Specifications](#)
See ITB Specifications
Fort Lauderdale FL 33301
Qty 1

Description

Double leaf swing gate (per swing segment) with 4" gate posts (Galvanized) Furnish all materials, labor, and/or equipment, to install double leaf swing gates to Galvanized chain link fence. This includes all associated Galvanized gate posts, fence fabric (9-gauge steel), and hardware. NOTE: The quantity as indicated is for City calculation purposes. The City shall purchase as many of these as required throughout the contract term.

Item **12493-512--01-36 - 6'H x (11' to 20')Wide Gate, Galvanized, Double Leaf Swing**

Quantity **1 each**

Unit Price

Delivery Location **City of Fort Lauderdale**

[See ITB Specifications](#)
See ITB Specifications
Fort Lauderdale FL 33301
Qty 1

Description

Double leaf swing gate (per swing segment) with 4" gate posts (Galvanized) Furnish all materials, labor, and/or equipment, to install double leaf swing gates to Galvanized chain link fence. This includes all associated Galvanized gate posts, fence fabric (9-gauge steel), and hardware. NOTE: The quantity as indicated is for City calculation purposes. The City shall purchase as many of these as required throughout the contract term.

Item **12493-512--01-37 - 8'H x (6' to 10')Wide Gate, Galvanized, Double Leaf Swing**

Quantity **1 each**

Unit Price

Delivery Location **City of Fort Lauderdale**

[See ITB Specifications](#)
See ITB Specifications
Fort Lauderdale FL 33301
Qty 1

Description

Double leaf swing gate (per swing segment) with 3" gate posts (Galvanized) Furnish all materials, labor, and/or equipment, to install double leaf swing gates to Galvanized chain link fence. This includes all associated Galvanized gate posts, fence fabric (9-gauge steel), and hardware. NOTE: The quantity as indicated is for City calculation purposes. The City shall purchase as many of these as required throughout the contract term.

Item **12493-512--01-38 - 8'H x (11' to 20')Wide Gate, Galvanized, Double Leaf Swing**
 Quantity **1 each**
 Unit Price
 Delivery Location **City of Fort Lauderdale**
 [See ITB Specifications](#)
 See ITB Specifications
 Fort Lauderdale FL 33301
 Qty 1

Description

Double leaf swing gate (per swing segment) with 4" gate posts (Galvanized) Furnish all materials, labor, and/or equipment, to install double leaf swing gates to Galvanized chain link fence. This includes all associated Galvanized gate posts, fence fabric (9-gauge steel), and hardware. NOTE: The quantity as indicated is for City calculation purposes. The City shall purchase as many of these as required throughout the contract term.

Item **12493-512--01-39 - 10'H x 5'W Gate, Galvanized, Double Leaf Swing**
 Quantity **1 each**
 Unit Price
 Delivery Location **City of Fort Lauderdale**
 [See ITB Specifications](#)
 See ITB Specifications
 Fort Lauderdale FL 33301
 Qty 1

Description

Double leaf swing gate (per swing segment) with 3" gate posts (Galvanized) Furnish all materials, labor, and/or equipment, to install double leaf swing gates to Galvanized chain link fence. This includes all associated Galvanized gate posts, fence fabric (9-gauge steel), and hardware. NOTE: The quantity as indicated is for City calculation purposes. The City shall purchase as many of these as required throughout the contract term.

Item **12493-512--01-40 - 10'H x (6' to 10')Wide Gate, Galvanized, Double Leaf Swing**
 Quantity **1 each**
 Unit Price
 Delivery Location **City of Fort Lauderdale**
 [See ITB Specifications](#)
 See ITB Specifications
 Fort Lauderdale FL 33301
 Qty 1

Description

Double leaf swing gate (per swing segment) with 3" gate posts (Galvanized) Furnish all materials, labor, and/or equipment, to install double leaf swing gates to Galvanized chain link fence. This includes all associated Galvanized gate posts, fence fabric (9-gauge steel), and hardware. NOTE: The quantity as indicated is for City calculation purposes. The City shall purchase as many of these as required throughout the contract term.

Item **12493-512--01-41 - 10'H x (11' to 20')Wide Gate, Galvanized, Double Leaf Swing**
 Quantity **1 each**
 Unit Price
 Delivery Location **City of Fort Lauderdale**
 [See ITB Specifications](#)

See ITB Specifications
 Fort Lauderdale FL 33301
Qty 1

Description

Double leaf swing gate (per swing segment) with 4" gate posts (Galvanized) Furnish all materials, labor, and/or equipment, to install double leaf swing gates to Galvanized chain link fence. This includes all associated Galvanized gate posts, fence fabric (9-gauge steel), and hardware.
 NOTE: The quantity as indicated is for City calculation purposes. The City shall purchase as many of these as required throughout the contract term.

Item **12493-512--01-42 - 6'H x (6' to 10')Wide Gate, PVC Coated, Double Leaf Swing**

Quantity **1 each**

Unit Price

Delivery Location **City of Fort Lauderdale**
[See ITB Specifications](#)
 See ITB Specifications
 Fort Lauderdale FL 33301
Qty 1

Description

Double leaf swing gate (per swing segment) with 3" gate posts (PVC coated) Furnish all materials, labor, and/or equipment, to install double leaf swing gates to PVC coated chain link fence. This includes all associated PVC coated gate posts, fence fabric (9-gauge steel), and hardware.
 NOTE: The quantity as indicated is for City calculation purposes. The City shall purchase as many of these as required throughout the contract term.

Item **12493-512--01-43 - 6'H x (11' to 20')Wide Gate, PVC Coated, Double Leaf Swing**

Quantity **1 each**

Unit Price

Delivery Location **City of Fort Lauderdale**
[See ITB Specifications](#)
 See ITB Specifications
 Fort Lauderdale FL 33301
Qty 1

Description

Double leaf swing gate (per swing segment) with 4" gate posts (PVC coated) Furnish all materials, labor, and/or equipment, to install double leaf swing gates to PVC coated chain link fence. This includes all associated PVC coated gate posts, fence fabric (9-gauge steel), and hardware.
 NOTE: The quantity as indicated is for City calculation purposes. The City shall purchase as many of these as required throughout the contract term.

Item **12493-512--01-44 - 8'H x (6' to 10')Wide Gate, PVC Coated, Double Leaf Swing**

Quantity **1 each**

Unit Price

Delivery Location **City of Fort Lauderdale**
[See ITB Specifications](#)
 See ITB Specifications
 Fort Lauderdale FL 33301
Qty 1

Description

Double leaf swing gate (per swing segment) with 3" gate posts (PVC coated) Furnish all materials, labor, and/or equipment, to install double leaf swing gates to PVC coated chain link fence. This includes all associated PVC coated gate posts, fence fabric (9-gauge steel), and hardware.
 NOTE: The quantity as indicated is for City calculation purposes. The City shall purchase as many of these as required throughout the contract term.

Item **12493-512--01-45 - 8'H x (11' to 20')Wide Gate, PVC Coated, Double Leaf Swing**
 Quantity **1 each**
 Unit Price
 Delivery Location **City of Fort Lauderdale**
 [See ITB Specifications](#)
 See ITB Specifications
 Fort Lauderdale FL 33301
 Qty 1

Description

Double leaf swing gate (per swing segment) with 4" gate posts (PVC coated) Furnish all materials, labor, and/or equipment, to install double leaf swing gates to PVC coated chain link fence. This includes all associated PVC coated gate posts, fence fabric (9-gauge steel), and hardware. NOTE: The quantity as indicated is for City calculation purposes. The City shall purchase as many of these as required throughout the contract term.

Item **12493-512--01-46 - 10'H x (6' to 10')Wide Gate, PVC Coated, Double Leaf Swing**
 Quantity **1 each**
 Unit Price
 Delivery Location **City of Fort Lauderdale**
 [See ITB Specifications](#)
 See ITB Specifications
 Fort Lauderdale FL 33301
 Qty 1

Description

Double leaf swing gate (per swing segment) with 3" gate posts (PVC coated) Furnish all materials, labor, and/or equipment, to install double leaf swing gates to PVC coated chain link fence. This includes all associated PVC coated gate posts, fence fabric (9-gauge steel), and hardware. NOTE: The quantity as indicated is for City calculation purposes. The City shall purchase as many of these as required throughout the contract term.

Item **12493-512--01-47 - 10'H x (11' to 20')Wide Gate, PVC Coated, Double Leaf Swing**
 Quantity **1 each**
 Unit Price
 Delivery Location **City of Fort Lauderdale**
 [See ITB Specifications](#)
 See ITB Specifications
 Fort Lauderdale FL 33301
 Qty 1

Description

Double leaf swing gate (per swing segment) with 4" gate posts (PVC coated) Furnish all materials, labor, and/or equipment, to install double leaf swing gates to PVC coated chain link fence. This includes all associated PVC coated gate posts, fence fabric (9-gauge steel), and hardware. NOTE: The quantity as indicated is for City calculation purposes. The City shall purchase as many of these as required throughout the contract term.

Item **12493-512--01-48 - 6' high x 16' wide cantilevered slide gate**
 Quantity **1 each**
 Unit Price
 Delivery Location **City of Fort Lauderdale**
 [Fort Lauderdale Executive Airport](#)

6000 NW 21 Avenue, #200
 Fort Lauderdale FL 33309
Qty 1

Description

Single rolling gate w/ 4" gate posts (Galvanized) Furnish all materials, labor, and/or equipment, to install single side rolling gate to Galvanized (g) chain link fence. This includes all associated Galvanized gate posts, fence fabric (9-gauge steel), and hardware.
 NOTE: The quantity as indicated is for City calculation purposes. The City shall purchase as many of these as required throughout the contract term.

Item **12493-512--01-49 - 3' High Steel Picket Fence**

Quantity **1 linear foot**

Unit Price

Delivery Location **City of Fort Lauderdale**
[See ITB Specifications](#)
 See ITB Specifications
 Fort Lauderdale FL 33301
Qty 1

Description

Provide price per linear foot to furnish all materials, labor, and/or equipment to install 3' high black (or other color_ decorative picket fencing or associated single side rolling gates, as seen in the accompanying details drawing sheet No. 2. This includes all the associated hardware to interface and/or connect to new or existing sections or columns, as well as all line posts, corner posts, and/or gate posts.
 Prior annual quantities estimated at 500 linear feet. Prior quantities are not indicative of future use.

Item **12493-512--01-50 - 6' High Steel Picket Fence**

Quantity **1 linear foot**

Unit Price

Delivery Location **City of Fort Lauderdale**
[See ITB Specifications](#)
 See ITB Specifications
 Fort Lauderdale FL 33301
Qty 1

Description

Provide price per linear foot to furnish all materials, labor, and/or equipment to install 6' high black (or other color) decorative picket fencing or associated single side rolling gates, as seen in the accompanying details drawing sheet No. 2. This includes all the associated hardware to interface and/or connect to new or existing sections or columns, as well as all line posts, corner posts, and/or gate posts.
 Prior annual quantities estimated at 2000 linear feet. Prior quantities are not indicative of future use.

Item **12493-512--01-51 - 8' High Steel Picket Fence**

Quantity **1 linear foot**

Unit Price

Delivery Location **City of Fort Lauderdale**
[See ITB Specifications](#)
 See ITB Specifications
 Fort Lauderdale FL 33301
Qty 1

Description

Provide price per linear foot to furnish all materials, labor, and/or equipment to install 8' high black (or other color) decorative picket fencing or associated single side rolling gates, as seen in the accompanying details drawing sheet No. 2. This includes all the associated hardware to interface and/or connect to new or existing sections or columns, as well as all line posts, and/or gate posts.

Prior annual quantities estimated at 2000 linear feet. Prior quantities are not indicative of future use.

Item **12493-512--01-52 - 10' High Steel Picket Fence**

Quantity **1 linear foot**

Unit Price

Delivery Location **City of Fort Lauderdale**
See ITB Specifications
 See ITB Specifications
 Fort Lauderdale FL 33301
Qty 1

Description

Provide price per linear foot to furnish all materials, labor, and/or equipment to install 10' high black (or other color) decorative picket fencing or associated single side rolling gates, as seen in the accompanying details drawing sheet No. 2. This includes all the associated hardware to interface and/or connect to new or existing sections or columns, as well as all line posts, corner posts, and/or gate posts. Prior annual quantities estimated at 2000 linear feet. Prior quantities are not indicative of future use.

Item **12493-512--01-53 - 6' High PVC Fence**

Quantity **1 linear foot**

Unit Price

Delivery Location **City of Fort Lauderdale**
See ITB Specifications
 See ITB Specifications
 Fort Lauderdale FL 33301
Qty 1

Description

Provide price per linear foot to furnish all materials, labor, and/or equipment, including clear and grubbing, to install 6' high PVC privacy fence. This includes all associated PVC posts, boards, and hardware. Prior annual quantities estimated at 500 linear feet. Prior quantities are not indicative of future use.

Item **12493-512--01-54 - 8' High PVC Privacy Fence**

Quantity **1 linear foot**

Unit Price

Delivery Location **City of Fort Lauderdale**
See ITB Specifications
 See ITB Specifications
 Fort Lauderdale FL 33301
Qty 1

Description

Provide price per linear foot to furnish all materials, labor, and/or equipment, including clear and grubbing, to install 8' high PVC privacy fence. This includes all associated PVC posts, boards, and hardware. Prior annual quantities estimated at 300 linear feet. Prior quantities are not indicative of future use.

Item **12493-512--01-55 - 6' High Single side Rolling Picket Gate**

Quantity **1 linear foot**

Unit Price

Delivery Location **City of Fort Lauderdale**

[See ITB Specifications](#)
 See ITB Specifications
 Fort Lauderdale FL 33301
Qty 1

Description

Provide price per linear foot to furnish all materials, labor, and/or equipment to install 6' high black (or other color) decorative picket fencing or associated single side rolling gates, as seen in the accompanying details drawing sheet No. 2. This includes all the associated hardware to interface and/or connect to new or existing sections or columns, as well as all line posts, corner posts, and/or gate posts. Prior annual quantities estimated at 240 linear feet. Prior quantities are not indicative of future use.

Item **12493-512--01-56 - 8' High Single side Rolling Picket Gate**
 Quantity **1 linear foot**
 Unit Price
 Delivery Location **City of Fort Lauderdale**
[See ITB Specifications](#)
 See ITB Specifications
 Fort Lauderdale FL 33301
Qty 1

Description

Price per linear foot to furnish all materials, labor, and/or equipment to install 8' high black (or other color) decorative picket fencing or associated single side rolling gates. This includes all the associated hardware to interface and/or connect to new or existing sections or columns, as well as all line posts, corner posts, and/or gate posts. Prior annual quantities estimated at 240 linear feet. Prior quantities are not indicative of future use.

Item **12493-512--01-57 - 10' High Single side Rolling Picket Gate**
 Quantity **1 linear foot**
 Unit Price
 Delivery Location **City of Fort Lauderdale**
[See ITB Specifications](#)
 See ITB Specifications
 Fort Lauderdale FL 33301
Qty 1

Description

Price per linear foot to furnish all materials, labor, and/or equipment to install 10' high black (or other color) decorative picket fencing or associated single side rolling gates. This includes all the associated hardware to interface and/or connect to new or existing sections or columns, as well as all line posts. Prior annual quantities estimated at 240 linear feet. Prior quantities are not indicative of future use.

Item **12493-512--01-58 - 62' long x 15.5' wide x 12' high Batting Cages**
 Quantity **1 each**
 Unit Price
 Delivery Location **City of Fort Lauderdale**
[See ITB Specifications](#)
 See ITB Specifications
 Fort Lauderdale FL 33301
Qty 1

Description

Price per each to furnish all materials, labor, and/or equipment, including any clear and grubbing, to install and/or repair (as needed) PVC coated galvanized chain link fence to the ball field's batting cage. This includes all associated PVC coated galvanized posts (end/corner,

tension, or terminal), fence fabric (9-gauge steel), support braces, and hardware.
Prior annual quantities estimated at 3 each. Prior quantities are not indicative of future use.

Item **12493-512--01-59 - 75' long x 15.5' wide x 12' high Batting Cages**
 Quantity **1 each**
 Unit Price
 Delivery Location **City of Fort Lauderdale**
[See ITB Specifications](#)
 See ITB Specifications
 Fort Lauderdale FL 33301
Qty 1

Description

Provide price per each to furnish all materials, labor, and/or equipment, including any clear and grubbing, to install and/or repair (as needed) PVC coated galvanized chain link fence to the ball field's batting cage. This includes all associated PVC coated galvanized posts (end/corner, tension, or terminal), fence fabric (9-gauge steel), support braces, and hardware.
Prior annual quantities estimated at 3 each. Prior quantities are not indicative of future use.

Item **12493-512--01-60 - Barbwire**
 Quantity **1 linear foot**
 Unit Price
 Delivery Location **City of Fort Lauderdale**
[See ITB Specifications](#)
 See ITB Specifications
 Fort Lauderdale FL 33301
Qty 1

Description

Provide price per linear foot to furnish all materials, labor, and/or equipment, to install barbwire to all heights (from 4' to 10') of Galvanized (g) chain link fence, and any accompanying single side rolling, single swing, or double leaf swing gates. This includes all associated hardware.
Prior annual quantities estimated at 1550 linear feet. Prior quantities are not indicative of future use.

Item **12493-512--01-61 - Bottom fence rail**
 Quantity **1 linear foot**
 Unit Price
 Delivery Location **City of Fort Lauderdale**
[See ITB Specifications](#)
 See ITB Specifications
 Fort Lauderdale FL 33301
Qty 1

Description

Provide price per linear foot to furnish all materials, labor, and/or equipment, to install flat galvanized bottom fence rail to all heights (from 4' to 30') of Galvanized (g) or PVC coated (c) chain link fence. This includes all associated hardware.
Prior annual quantities estimated at 1200 linear feet. Prior quantities are not indicative of future use.

Item **12493-512--01-62 - Bottom Tension Wire, Galvanized, 7 gauge**
 Quantity **1 linear foot**
 Unit Price
 Delivery Location **City of Fort Lauderdale**
[See ITB Specifications](#)

See ITB Specifications
 Fort Lauderdale FL 33301
Qty 1

Description

Provide price per linear foot to furnish all materials, labor, and/or equipment, to install galvanized bottom tension wire to all heights (from 4' to 30') of Galvanized (g) chain link fence. This includes all associated hardware.
 Prior annual quantities estimated at 750 linear feet. Prior quantities are not indicative of future use.

Item **12493-512--01-63 - Bottom Tension Wire, PVC Coated, 7 gauge**

Quantity **1 linear foot**

Unit Price

Delivery Location **City of Fort Lauderdale**

[See ITB Specifications](#)
 See ITB Specifications
 Fort Lauderdale FL 33301
Qty 1

Description

Price per linear foot to furnish all materials, labor, and/or equipment, to install PVC coated bottom tension wire to all heights (from 4' to 30') of PVC coated (c) chain link fence. This includes all associated hardware.
 Prior annual quantities estimated at 750 linear feet. Prior quantities are not indicative of future use.

Item **12493-512--01-64 - Substitute Bottom Tension Wire with Flat Galvanized Bottom Rail**

Quantity **1 linear foot**

Unit Price

Delivery Location **City of Fort Lauderdale**

[See ITB Specifications](#)
 See ITB Specifications
 Fort Lauderdale FL 33301
Qty 1

Description

Provide price per linear foot to furnish all materials, labor, and equipment to substitute bottom tension wire with flat galvanized bottom rail.
 Prior annual quantities estimated at 500 linear feet. Prior quantities are not indicative of future use.

Item **12493-512--01-65 - Adjust, straighten, tighten, and/or repair existing rail...**

Quantity **1 linear foot**

Unit Price

Delivery Location **City of Fort Lauderdale**

[See ITB Specifications](#)
 See ITB Specifications
 Fort Lauderdale FL 33301
Qty 1

Description

Provide price per linear foot to furnish all materials, labor, and/or equipment, to adjust, straighten, tighten, and/or repair existing rail (top, middle, or bottom), line post, corner post, gate post, barbwire, or fence fabric of all heights (from 4' to 10') of Galvanized (g) or PVC coated (c) chain link fence. This includes all associated hardware, and with all applicable posts being secured with 3000 PSI concrete.
 Prior annual quantities estimated at 700 linear feet. Prior quantities are not indicative of future use.

Item **12493-512--01-66 - Install and substitute 4" posts**

Quantity **1 each**
 Unit Price
 Delivery Location **City of Fort Lauderdale**
[See ITB Specifications](#)
 See ITB Specifications
 Fort Lauderdale FL 33301
Qty 1

Description

Provide price per each to furnish all materials, labor, and/or equipment, to install and substitute 4" posts as requested by City staff. Prior annual quantities estimated at 20 each. Prior quantities are not indicative of future use.

Item **12493-512-01-67 - Repair Electronic Gate Closure Motors**
 Quantity **1 hour**
 Unit Price
 Delivery Location **City of Fort Lauderdale**
[See ITB Specifications](#)
 See ITB Specifications
 Fort Lauderdale FL 33301
Qty 1

Description

Provide price per hour to furnish all materials, labor, and/or equipment to repair electronic gate closure motors. This includes all the associated hardware and electrical components. Prior annual quantities estimated at 200 hours. Prior quantities are not indicative of future use.

Item **12493-512-01-68 - Install New Electronic Gate Closure Motors**
 Quantity **1 hour**
 Unit Price
 Delivery Location **City of Fort Lauderdale**
[See ITB Specifications](#)
 See ITB Specifications
 Fort Lauderdale FL 33301
Qty 1

Description

Provide price per hour to furnish all materials, labor, and/or equipment to install electronic gate closure motors. This includes all the associated hardware and electrical components. Prior annual quantities estimated at 200 hours. Prior quantities are not indicative of future use.

Item **12493-512-01-69 - Forman for fence construction /repair - For additional jobs not indicated**
 Quantity **1 hour**
 Unit Price
 Delivery Location **City of Fort Lauderdale**
[See ITB Specifications](#)
 See ITB Specifications
 Fort Lauderdale FL 33301
Qty 1

Description

Provide price per hour for Forman for fence constructions/repair - for any additional jobs/requests not specifically indicated in this bid. (Labor

prices shall be included in your unit price for items indicated)
 Prior annual quantities estimated at 200 hours. Prior quantities are not indicative of future use.

Item **12493-512--01-70 - Laborer for fence construction / repairs - For additional jobs not indicated**
 Quantity **1 hour**
 Unit Price
 Delivery Location **City of Fort Lauderdale**
See ITB Specifications
 See ITB Specifications
 Fort Lauderdale FL 33301
Qty 1

Description

Provide price per hour for Laborer for fence construction/repair for additional jobs/requests not specifically indicated in this bid (Labor prices shall be included in your unit price for items indicated).
 Prior annual quantities estimated at 100 hours. Prior quantities are not indicative of future use.

Item **12493-512--01-71 - Formans helper**
 Quantity **1 hour**
 Unit Price
 Delivery Location **City of Fort Lauderdale**
See ITB Specifications
 See ITB Specifications
 Fort Lauderdale FL 33301
Qty 1

Description

Provide price per hour for Forman Helper for fence construction/repair for additional jobs/requests not specifically indicated in this bid (Labor prices shall be included in your unit price for items indicated).
 Prior annual quantities estimated at 100 hours. Prior quantities are not indicative of future use.

City of Fort Lauderdale
Fence, Chain Link and Picket
ITB # 12493-512

SECTION I – INTRODUCTION AND INFORMATION

1.1 Purpose

The City of Fort Lauderdale, Florida (City) is seeking bids from qualified, experienced and licensed firm(s), hereinafter referred to as the Contractor or Bidder, to provide fence installation and repair for the City, in accordance with the terms, conditions, and specifications contained in this Invitation to Bid (ITB).

1.2 BidSync

The City of Fort Lauderdale uses BidSync (www.bidsync.com) to administer the competitive solicitation process, including but not limited to soliciting proposals, issuing addenda, posting results and issuing notification of an intended decision. There is no charge to register and download the ITB from BidSync. Proposers are strongly encouraged to read the various vendor Guides and Tutorials available in BidSync well in advance of their intention of submitting a proposal to ensure familiarity with the use of BidSync. The City shall not be responsible for a Proposers inability to submit a Proposal by the end date and time for any reason, including issues arising from the use of BidSync.

It is the sole responsibility of the Bidder to ensure that their bid is submitted electronically through BidSync at www.bidsync.com no later than the time and date specified in this solicitation. PAPER BID SUBMITTALS WILL NOT BE ACCEPTED. BIDS MUST BE SUBMITTED ELECTRONICALLY VIA WWW.BIDSYNC.COM.

1.3 Electronic Bid Openings

Please be advised that effective immediately, and until further notice, all Invitation to Bids, Request For Proposals, Request For Qualifications, and other solicitations led by the City of Fort Lauderdale will be opened electronically via BIDSYNC.COM at the date and time indicated on the solicitation. All openings will be held on the BIDSYNC.COM platform.

Anyone requesting assistance or having further inquiry in this matter must contact the Procurement Specialist indicated on the solicitation, via the question and Answer forum on Bidsync.com before the Last Day for Questions indicated in the Solicitation.

1.4 Point of Contact

For information concerning procedures for responding to this solicitation, contact Procurement Specialist, AnnDebra Diaz, at (954) 828-5949 or email at adiaz@fortlauderdale.gov. Such contact shall be for clarification purposes only.

For information concerning technical specifications, please utilize the question / answer feature provided by BidSync at www.bidsync.com. Questions of a material nature must be received prior to the cut-off date specified in the ITB schedule. Material changes, if any, to the scope of services or bidding procedures will only be transmitted by written addendum. (See addendum section of BidSync Site). Bidders please note: No part of your bid can be submitted via FAX. No variation in price or conditions shall be permitted based upon a claim of ignorance. Submission of a bid will be considered evidence that the Bidder has familiarized themselves with the nature and extent of the work, and the equipment, materials, and labor required. The entire bid response must be submitted in accordance with all specifications contained in this solicitation. The questions and answers submitted in BidSync shall become part of any contract that is created from this ITB.

1.5 Pre-bid Conference and/or Site Visit

There will not be a pre-bid conference or site visit for this ITB.

It will be the sole responsibility of the Bidder to become familiar with the scope of the City's requirements and systems prior to submitting a bid. No variation in price or conditions shall be permitted based upon a claim of ignorance. Submission of a bid will be considered evidence that the Bidder has familiarized themselves with the nature and extent of the work, equipment, materials, and labor required.

END OF SECTION

SECTION II - SPECIAL TERMS AND CONDITIONS

2.1 General Conditions

ITB General Conditions (Form G-107, Rev. 09/20) are included and made a part of this ITB.

2.2 Addenda, Changes, and Interpretations

It is the sole responsibility of each firm to notify the Procurement Specialist utilizing the question / answer feature provided by BidSync and request modification or clarification of any ambiguity, conflict, discrepancy, omission or other error discovered in this competitive solicitation. Requests for clarification, modification, interpretation, or changes must be received prior to the Question and Answer (Q & A) Deadline. Requests received after this date may not be addressed. Questions and requests for information that would not materially affect the scope of services to be performed or the solicitation process will be answered within the question / answer feature provided by BidSync and shall be for clarification purposes only. Material changes, if any, to the scope of services or the solicitation process will only be transmitted by official written addendum issued by the City and uploaded to BidSync as a separate addendum to the ITB. Under no circumstances shall an oral explanation given by any City official, officer, staff, or agent be binding upon the City and should be disregarded. All addenda are a part of the competitive solicitation documents and each firm will be bound by such addenda. It is the responsibility of each to read and comprehend all addenda issued.

2.3 Changes and Alterations

Bidder may change or withdraw a Bid at any time prior to Bid submission deadline; however, no oral modifications will be allowed. Modifications shall not be allowed following the Bid deadline.

2.4 Bidder's Costs

The City shall not be liable for any costs incurred by Bidders in responding to this ITB.

2.5 Pricing/Delivery

All pricing should be identified on the Cost page provided in this ITB. No additional costs may be accepted, other than the costs stated on the Cost page. Failure to use the City's Cost page and provide costs as requested in this ITB may deem your bid non-responsive.

Bidder shall quote a firm, fixed price for all services and products stated in the ITB. All costs including travel shall be included in your cost. The City shall not accept any additional costs including any travel associated with coming to the City of Fort Lauderdale. The City of Fort Lauderdale will not accept any bids that do not guarantee a firm price until completion of order.

Failure to provide costs as requested in this ITB may deem your bid non-responsive.

2.6 Price Validity

Prices provided in this Invitation to bid (ITB) shall be valid for at least One-Hundred and Twenty (120) days from time of ITB opening unless otherwise extended and agreed upon by the City and Bidder. The City shall award contract within this time period or shall request to the recommended awarded vendor an extension to hold pricing, until products/services have been awarded.

2.7 Invoices/Payment

Payment terms will be considered to be net 45 days after the date of satisfactory delivery at the place of acceptance and receipt of correct invoice at the office specified, whichever occurs

last, in accordance with the Florida Local Government Prompt Payment Act. Bidder may offer cash discounts for prompt payment but they will not be considered in determination of award.

2.8 Related Expenses/Travel Expenses

All costs including travel are to be included in your bid. The City will not accept any additional costs.

2.9 Payment Method

The City of Fort Lauderdale has implemented a Procurement Card (P-Card) program which changes how payments are remitted to its vendors. The City has transitioned from traditional paper checks to payment by credit card via MasterCard or Visa. This allows you as a vendor of the City of Fort Lauderdale to receive your payment fast and safely. No more waiting for checks to be printed and mailed. Payments will be made utilizing the City's P-Card (MasterCard or Visa). Accordingly, firms must presently have the ability to accept credit card payment or take whatever steps necessary to implement acceptance of a credit card before the commencement of a contract. See Contract Payment Method form attached.

2.10 Mistakes

The Bidder shall examine this ITB carefully. The submission of a bid shall be prima facie evidence that the Bidder has full knowledge of the scope, nature, and quality of the work to be performed; the detailed requirements of the specifications; and the conditions under which the work is to be performed. Ignorance of the requirements will not relieve the Bidder from liability and obligations under the Contract.

2.11 Acceptance of Bids / Minor Irregularities

2.11.1 The City reserves the right to accept or reject any or all bids, part of bids, and to waive minor irregularities or variances to specifications contained in bids which do not make the bid conditional in nature and minor irregularities in the solicitation process. A minor irregularity shall be a variation from the solicitation that does not affect the price of the contract or does not give a bidder an advantage or benefit not enjoyed by other bidders, does not adversely impact the interests of other firms or, does not affect the fundamental fairness of the solicitation process. The City also reserves the right to reissue an ITB.

2.11.2 The City reserves the right to disqualify Bidder during any phase of the competitive solicitation process and terminate for cause any resulting contract upon evidence of collusion with intent to defraud or other illegal practices on the part of the Bidder.

2.12 Modification of Services

2.12.1 While this contract is for services provided to the department referenced in this ITB, the City may require similar work for other City departments. Successful Bidder agrees to take on such work unless such work would not be considered reasonable or become an undue burden to the Successful Bidder.

2.12.2 The City reserves the right to delete any portion of the work at any time without cause, and if such right is exercised by the City, the total fee shall be reduced in the same ratio as the estimated cost of the work deleted bears to the estimated cost of the work originally planned. If work has already been accomplished and approved by the City on any portion of a contract resulting from this ITB, the Successful Bidder shall be paid for the work completed on the basis of the estimated percentage of completion of such portion to the total project cost.

2.12.3 The City may require additional items or services of a similar nature, but not specifically listed in the contract. The Successful Bidder agrees to provide such items or services and shall provide the City prices on such additional items or services. If the price(s) offered are not acceptable to the City, and the situation cannot be resolved to the satisfaction of the City, the City reserves the right to procure those items or services from other vendors, or to cancel the contract upon giving the Successful Bidder thirty (30) days written notice.

2.12.4 If the Successful Bidder and the City agree on modifications or revisions to the task elements, after the City has approved work to begin on a particular task or project, and a budget has been established for that task or project, the Successful Bidder will submit a revised budget to the City for approval prior to proceeding with the work.

2.13 No Exclusive Contract

Bidder agrees and understands that the contract shall not be construed as an exclusive arrangement and further agrees that the City may, at any time, secure similar or identical services from another vendor at the City's sole option.

2.14 Sample Contract Agreement

A sample of the formal agreement template, which may be required to be executed by the awarded vendor can be found at our website:

<https://www.fortlauderdale.gov/home/showdocument?id=1212>

2.15 Responsiveness

In order to be considered responsive to the solicitation, the firm's bid shall fully conform in all material respects to the solicitation and all of its requirements, including all form and substance.

2.16 Responsibility

In order to be considered as a responsible firm, firm shall be fully capable to meet all of the requirements of the solicitation and subsequent contract, must possess the full capability, including financial and technical, to perform as contractually required, and must be able to fully document the ability to provide good faith performance.

2.17 Minimum Qualifications

To be eligible for award of a contract in response to this solicitation, the Bidder must demonstrate that they have successfully completed services, as specified in the Technical Specifications / Scope of Services section of this solicitation, are normally and routinely engaged in performing such services, and are properly and legally licensed to perform such work for a minimum of three years. In addition, the Bidder must have no conflict of interest with regard to any other work performed by the Bidder for the City of Fort Lauderdale.

To be eligible for award of a contract in response to this solicitation, the Bidder must possess at time of bid submittal a State of Florida Certified General Contractor license or equivalent Broward County Contractor license, certificate of competency, or other license that meets or exceeds those specified herein.

2.17.1 Firm or principals shall have no record of judgments, pending lawsuits against the City or criminal activities involving moral turpitude and not have any conflicts of interest that have not been waived by the City Commission.

2.17.2 Neither firm nor any principal, officer, or stockholder shall be in arrears or in default of any debt or contract involving the City, (as a party to a contract, or otherwise); nor have failed to perform faithfully on any previous contract with the City.

2.18 Lobbying Activities

ALL CONTRACTORS PLEASE NOTE: Any contractor submitting a response to this solicitation must comply, if applicable, with City of Fort Lauderdale Ordinance No. C-11-42 & Resolution No. 07-101, Lobbying Activities. Copies of Ordinance No. C-11-42 and Resolution No. 07-101 may be obtained from the City Clerk's Office on the 7th Floor of City Hall, 100 N. Andrews Avenue, Fort Lauderdale, Florida. The ordinance may also be viewed on the City's website at <http://www.fortlauderdale.gov/home/showdocument?id=6036>.

2.19 Local Business Preference

2.19.1 Section 2-186, Code of Ordinances of the City of Fort Lauderdale, provides for a local business preference. In order to be considered for a local business preference, a proposer must include the Local Business Preference Certification Statement of this ITB, as applicable to the local business preference class claimed at the time of Bid submittal:

2.19.2 Upon formal request of the City, based on the application of a Local Business Preference the Proposer shall within ten (10) calendar days submit the following documentation to the Local Business Preference Class claimed:

- a. Copy of City of Fort Lauderdale current year business tax receipt, or Broward County current year business tax receipt, and
- b. List of the names of all employees of the proposer and evidence of employees' residence within the geographic bounds of the City of Fort Lauderdale or Broward County, as the case may be, such as current Florida driver license, residential utility bill (water, electric, telephone, cable television), or other type of similar documentation acceptable to the City.

2.19.3 Failure to comply at time of Proposal submittal shall result in the Proposer being found ineligible for the local business preference.

2.19.4 The complete local business preference ordinance may be found on the City's web site at the following link:

https://library.municode.com/fl/fort_lauderdale/codes/code_of_ordinances?nodeId=CO_OR_CH2AD_ARTVFI_DIV2PR_S2-186LOBUPRPR

2.19.5 Definitions

a. The term "Class A business" shall mean any business that has established and agrees to maintain a permanent place of business located in a non-residential zone, staffed with full-time employees within the limits of the city, and shall maintain a staffing level for the proposed work of at least fifty percent (50%) who are residents of the City of Fort Lauderdale.

b. The term "Class B business" shall mean any business that has established and agrees to maintain a permanent place of business located in a non-residential zone, staffed with full-time employees within the limits of the city, or shall maintain a staffing level for the proposed work of at least fifty percent (50%) who are residents of the City of Fort Lauderdale.

- c. The term "Class C business" shall mean any business that has established and agrees to maintain a permanent place of business located in a non-residential zone, staffed with full-time employees within the limits of Broward County.
- d. The term "Class D business" shall mean any business that does not qualify as a Class A, Class B, or Class C business.

2.20 Protest Procedure

2.20.1 Any Bidder who is not recommended for award of a contract and who alleges a failure by the city to follow the city's procurement ordinance or any applicable law, may follow the protest procedure as found in the city's procurement ordinance within five (5) days after a notice of intent to award is posted on the city's web site at the following link: <http://www.fortlauderdale.gov/departments/finance/procurement-services/notices-of-intent-to-award>.

2.20.2 The complete protest ordinance may be found on the city's web site at the following link: https://library.municode.com/fl/fort_lauderdale/codes/code_of_ordinances?nodeId=COOR_CH2AD_ARTVFI_DIV2PR_S2-182DIREPR

2.21 Public Entity Crimes

Bidder, by submitting a bid, certifies that neither the Bidder nor any of the Bidder's principals has been placed on the convicted vendor list as defined in Section 287.133, Florida Statutes (2018), as may be amended or revised. A person or affiliate who has been placed on the convicted vendor list following a conviction for a public entity crime may not submit a bid, proposal, or reply on a contract to provide any goods or services to a public entity; may not submit a bid, proposal, or reply on a contract with a public entity for the construction or repair of a public building or public work; may not submit bids, proposals, or replies on leases of real property to a public entity; may not be awarded or perform work as a contractor, supplier, subcontractor, or consultant under a contract with any public entity; and may not transact business with any public entity in excess of the threshold amount provided in s. 287.017 for CATEGORY TWO for a period of 36 months following the date of being placed on the convicted vendor list.

2.22 Sub-Contractors

2.22.1 If the Contractor proposes to use sub-contractors in the course of providing these services to the City, this information shall be a part of the bid response. Such information shall be subject to review, acceptance and approval of the City, prior to any contract award. The City reserves the right to approve or disapprove of any sub-contractor candidate in its best interest and to require Contractor to replace sub-contractor with one that meets City approval.

2.22.2 Contractor shall ensure that all of Contractor's sub-contractors perform in accordance with the terms and conditions of this Contract. Contractor shall be fully responsible for all of Contractor's sub-contractors' performance, and liable for any of Contractor's sub-contractor's non-performance and all of Contractor's sub-contractors' acts and omissions. Contractor shall defend, at Contractor's expense, counsel being subject to the City's approval or disapproval, and indemnify and hold harmless the City and the City's officers, employees, and agents from and against any claim, lawsuit, third-party action, or judgment, including any award of attorney fees and any award of costs, by or in favor of any Contractor's sub-contractors for payment for work performed for the City.

2.22.3 Contractor shall require all of its sub-contractors to provide the required insurance coverage as well as any other coverage that the Contractor may consider necessary, and any deficiency in the coverage or policy limits of said sub-contractors will be the sole responsibility of the Contractor.

2.23 Bid Security – N/A

2.24 Payment and Performance Bond – N/A

2.25 Insurance Requirements

2.25.1 As a condition precedent to the effectiveness of this Agreement, during the term of this Agreement and during any renewal or extension term of this Agreement, the Contractor, at the Contractor's sole expense, shall provide insurance of such types and with such terms and limits as noted below. Providing proof of and maintaining adequate insurance coverage are material obligations of the Contractor. The Contractor shall provide the City a certificate of insurance evidencing such coverage. The Contractor's insurance coverage shall be primary insurance for all applicable policies. The limits of coverage under each policy maintained by the Contractor shall not be interpreted as limiting the Contractor's liability and obligations under this Agreement. All insurance policies shall be from insurers authorized to write insurance policies in the State of Florida and that possess an A.M. Best rating of "A-" VII or better. All insurance policies are subject to approval by the City's Risk Manager.

2.25.2 The coverages, limits, and endorsements required herein protect the interests of the City, and these coverages, limits, and endorsements may not be relied upon by the Contractor for assessing the extent or determining appropriate types and limits of coverage to protect the Contractor against any loss exposure, whether as a result of this Agreement or otherwise. The requirements contained herein, as well as the City's review or acknowledgement, are not intended to and shall not in any manner limit or qualify the liabilities and obligations assumed by the Contractor under this Agreement.

2.25.3 The following insurance policies and coverages are required:

Commercial General Liability

Coverage must be afforded under a Commercial General Liability policy with limits not less than:

- \$1,000,000 each occurrence and \$2,000,000 aggregate for Bodily Injury, Property Damage, and Personal and Advertising Injury
- \$1,000,000 each occurrence and \$2,000,000 aggregate for Products and Completed Operations

Policy must include coverage for Contractual Liability and Independent Contractors.

The City and the City's officers, employees, and volunteers are to be covered as additional insureds with a CG 20 26 04 13 Additional Insured – Designated Person or Organization Endorsement or similar endorsement providing equal or broader Additional Insured Coverage with respect to liability arising out of activities performed by or on behalf of the Contractor. The coverage shall contain no special limitation on the scope of protection afforded to the City or the City's officers, employees, and volunteers.

Business Automobile Liability

Coverage must be afforded for all Owned, Hired, Scheduled, and Non-Owned vehicles for Bodily Injury and Property Damage in an amount not less than \$1,000,000 combined single limit each accident.

If the Contractor does not own vehicles, the Contractor shall maintain coverage for Hired and Non-Owned Auto Liability, which may be satisfied by way of endorsement to the Commercial General Liability policy or separate Business Auto Liability policy.

Workers' Compensation and Employer's Liability

Coverage must be afforded per Chapter 440, Florida Statutes. Any person or entity performing work for or on behalf of the City must provide Workers' Compensation insurance. Exceptions and exemptions will be allowed by the City's Risk Manager, if they are in accordance with Florida Statute.

The Contractor waives, and the Contractor shall ensure that the Contractor's insurance carrier waives, all subrogation rights against the City and the City's officers, employees, and volunteers for all losses or damages. The City requires the policy to be endorsed with WC 00 03 13 Waiver of our Right to Recover from Others or equivalent.

The Contractor must be in compliance with all applicable State and federal workers' compensation laws, including the U.S. Longshore Harbor Workers' Act and the Jones Act, if applicable.

2.25.4 Insurance Certificate Requirements

- a. The Contractor shall provide the City with valid Certificates of Insurance (binders are unacceptable) no later than thirty (30) days prior to the start of work contemplated in this Agreement.
- b. The Contractor shall provide to the City a Certificate of Insurance having a thirty (30) day notice of cancellation; ten (10) days' notice if cancellation is for nonpayment of premium.
- c. In the event that the insurer is unable to accommodate the cancellation notice requirement, it shall be the responsibility of the Contractor to provide the proper notice. Such notification will be in writing by registered mail, return receipt requested, and addressed to the certificate holder.
- d. In the event the Agreement term goes beyond the expiration date of the insurance policy, the Contractor shall provide the City with an updated Certificate of Insurance no later than ten (10) days prior to the expiration of the insurance currently in effect. The City reserves the right to suspend the Agreement until this requirement is met.
- e. The Certificate of Insurance shall indicate whether coverage is provided under a claims-made or occurrence form. If any coverage is provided on a claims-made form, the Certificate of Insurance must show a retroactive date, which shall be the effective date of the initial contract or prior.
- f. The City shall be named as an Additional Insured on the general liability policy.
- g. The City shall be granted a Waiver of Subrogation on the Contractor's Workers' Compensation insurance policy.
- h. The title of the Agreement, Bid/Contract number, event dates, or other identifying reference must be listed on the Certificate of Insurance.

The Certificate Holder should read as follows:

City of Fort Lauderdale

Procurement Services Division
100 N. Andrews Avenue
Fort Lauderdale, FL 33301

- 2.25.5** The Contractor has the sole responsibility for the payment of all insurance premiums and shall be fully and solely responsible for any costs or expenses as a result of a coverage deductible, co-insurance penalty, or self-insured retention; including any loss not covered because of the operation of such deductible, co-insurance penalty, self-insured retention, or coverage exclusion or limitation. Any costs for adding the City as an Additional Insured shall be at the Contractor's expense.
- 2.25.6** If the Contractor's primary insurance policy/policies do not meet the minimum requirements, as set forth in this Agreement, the Contractor may provide evidence of an Umbrella/Excess insurance policy to comply with this requirement.
- 2.25.7** The Contractor's insurance coverage shall be primary insurance as applied to the City and the City's officers, employees, and volunteers. Any insurance or self-insurance maintained by the City covering the City, the City's officers, employees, or volunteers shall be non-contributory.
- 2.25.8** Any exclusion or provision in the insurance maintained by the Contractor that excludes coverage for work contemplated in this Agreement shall be unacceptable and shall be considered breach of contract.
- 2.25.9** All required insurance policies must be maintained until the contract work has been accepted by the City, or until this Agreement is terminated, whichever is later. Any lapse in coverage shall be considered breach of contract. In addition, Contractor must provide to the City confirmation of coverage renewal via an updated certificate should any policies expire prior to the expiration of this Agreement. The City reserves the right to review, at any time, coverage forms and limits of Contractor's insurance policies.
- 2.25.10** The Contractor shall provide notice of any and all claims, accidents, and any other occurrences associated with this Agreement shall be provided to the Contractor's insurance company or companies and the City's Risk Management office as soon as practical.
- 2.25.11** It is the Contractor's responsibility to ensure that any and all of the Contractor's independent contractors and subcontractors comply with these insurance requirements. All coverages for independent contractors and subcontractors shall be subject to all of the applicable requirements stated herein. Any and all deficiencies are the responsibility of the Contractor.

2.26 Insurance – Sub-Contractors

Contractor shall require all of its Sub-Contractors to provide the aforementioned coverage as well as any other coverage that the Contractor may consider necessary, and any deficiency in the coverage or policy limits of said Sub-Contractors will be the sole responsibility of the Contractor.

2.27 Insurance for Collection of Credit Card Payments – N/A

2.28 Award of Contract

Award may be in the aggregate, or by line item, or by group, whichever is determined to be in the best interest of the City. Award will be made to the responsive and responsible bidder, quoting the lowest price, for that product/service that will best serve the needs of the City of Fort Lauderdale.

The City also reserves the right to accept or reject any or all bids, part of bids, and to waive minor irregularities or variations to specifications contained in bids, and minor irregularities in the bidding process. The City also reserves the right to award the contract on a split order basis, lump sum basis, individual item basis, or such combination as shall best serve the interest of the City.

2.29 Damage to Public or Private Property

Extreme care shall be taken to safeguard all existing facilities, site amenities, irrigation systems, vehicles, etc. on or around the job site. Damage to public and/or private property shall be the responsibility of the Contractor and shall be repaired and/or replaced at no additional cost to the City.

2.30 Safety

The Contractor(s) shall adhere to the Florida Department of Transportation's Uniform manual on Traffic Control for construction and maintenance work zones when working on or near a roadway. It will be the sole responsibility of the Contractor to make themselves and their employees fully aware of these provisions, especially those applicable to safety.

2.31 Uncontrollable Circumstances ("Force Majeure")

The City and Contractor will be excused from the performance of their respective obligations under this agreement when and to the extent that their performance is delayed or prevented by any circumstances beyond their control including, fire, flood, explosion, strikes or other labor disputes, act of God or public emergency, war, riot, civil commotion, malicious damage, act or omission of any governmental authority, delay or failure or shortage of any type of transportation, equipment, or service from a public utility needed for their performance, provided that:

2.31.1 The non-performing party gives the other party prompt written notice describing the particulars of the Force Majeure including, but not limited to, the nature of the occurrence and its expected duration, and continues to furnish timely reports with respect thereto during the period of the Force Majeure;

2.31.2 The excuse of performance is of no greater scope and of no longer duration than is required by the Force Majeure;

2.31.3 No obligations of either party that arose before the Force Majeure causing the excuse of performance are excused as a result of the Force Majeure; and

2.31.4 The non-performing party uses its best efforts to remedy its inability to perform. Notwithstanding the above, performance shall not be excused under this Section for a period in excess of two (2) months, provided that in extenuating circumstances, the City may excuse performance for a longer term. Economic hardship of the Contractor will not constitute Force Majeure. The term of the agreement shall be extended by a period equal to that during which either party's performance is suspended under this Section.

2.32 Canadian Companies

In the event Contractor is a corporation organized under the laws of any province of Canada or is a Canadian federal corporation, the City may enforce in the United States of America or in Canada or in both countries a judgment entered against the Contractor. The Contractor waives any and all defenses to the City's enforcement in Canada, of a judgment entered by a court in the United States of America. All monetary amounts set forth in this Contract are in United States dollars.

2.33 News Releases/Publicity

News releases, publicity releases, or advertisements relating to this contract or the tasks or projects associated with the project shall not be made without prior City approval.

2.34 Approved Equal or Alternative Product Bids

The Technical Specifications contained in this solicitation are to be used as a reference only and are not to be considered of a proprietary nature. These specifications represent a level of quality and features that are desired by the City of Fort Lauderdale. The City is receptive to any product that would be considered by qualified City personnel as an approved equal.

The Contractor must state clearly in their bid pages any variance to the specifications. If proposing an approved equal or alternate product, it will be the Contractor's responsibility to provide adequate information in their proposal to enable the City to ensure that the Contractor meets the required criteria. If adequate information is not submitted with the bid, it may be rejected.

The City of Fort Lauderdale will be the sole judge in determining if the product proposed qualifies as approved equal. The City reserves the right to award to that Contractor which will best serve the interest of the City as determined by the City. The City further reserves the right to waive minor variations to specifications and in the bidding process.

2.35 Contract Period

The initial contract term shall commence upon date of award by the City or June 6, 2021, whichever is later, and shall expire one year from that date. The City reserves the right to extend the contract for three, additional one-year terms, providing all terms conditions and specifications remain the same, both parties agree to the extension, and such extension is approved by the City.

In the event services are scheduled to end because of the expiration of this contract, the Contractor shall continue the service upon the request of the City as authorized by the awarding authority. The extension period shall not extend for more than 180 days beyond the expiration date of the existing contract. The Contractor shall be compensated for the service at the rate in effect when this extension clause is invoked by the City.

2.36 Cost Adjustments

Prices quoted shall be firm for the initial contract term of one year. No cost increases shall be accepted in this initial contract term. Please consider this when providing pricing for this request for proposal.

Thereafter, any extensions which may be approved by the City shall be subject to the following: costs for any extension terms shall be subject to an adjustment only if increases or decreases occur in the industry. Such adjustment shall be based on the latest yearly percentage increase in the All Urban Consumers Price Index (CPI-U) as published by the Bureau of Labor Statistics, U.S. Dep't. of Labor and shall not exceed five percent (5%).

The yearly increase or decrease in the CPI shall be that latest Index published and available for the calendar year ending 12/31, prior to the end of the contract year then in effect, as compared to the index for the comparable month, one-year prior.

Any requested adjustment shall be fully documented and submitted to the City at least ninety (90) days prior to the contract anniversary date. Any approved cost adjustments shall become effective on the beginning date of the approved contract extension.

The City may, after examination, refuse to accept the adjusted costs if they are not properly documented, or considered to be excessive, or if decreases are considered to be insufficient. In the event the City does not wish to accept the adjusted costs and the matter cannot be resolved to the satisfaction of the City, the Contract will be considered cancelled on the scheduled expiration date.

2.37 Service Test Period

If the Contractor has not previously performed the services to the city, the City reserves the right to require a test period to determine if the Contractor can perform in accordance with the requirements of the contract, and to the City's satisfaction. Such test period can be from thirty to ninety days, and will be conducted under all specifications, terms and conditions contained in the contract. This trial period will then become part of the initial contract period.

A performance evaluation will be conducted prior to the end of the test period and that evaluation will be the basis for the City's decision to continue with the Contractor or to select another Contractor (if applicable).

2.38 Contract Coordinator

The City may designate a Contract Coordinator whose principal duties shall be:

- Liaison with Contractor.
- Coordinate and approve all work under the contract.
- Resolve any disputes.
- Assure consistency and quality of Contractor's performance.
- Schedule and conduct Contractor performance evaluations and document findings.
- Review and approve for payment all invoices for work performed or items delivered.

2.39 Contractor Performance Reviews and Ratings

The City Contract Coordinator may develop a Contractor performance evaluation report. This report shall be used to periodically review and rate the Contractor's performance under the contract with performance rating as follows:

Excellent	Far exceeds requirements.
Good	Exceeds requirements
Fair	Just meets requirements.
Poor	Does not meet all requirements and contractor is subject to penalty provisions under the contract.
Non-compliance	Either continued poor performance after notice or a performance level that does not meet a significant portion of the requirements. This rating makes the Contractor subject to the default or cancellation for cause provisions of the contract.

The report shall also list all discrepancies found during the review period. The Contractor shall be provided with a copy of the report and may respond in writing if he takes exception to the report or wishes to comment on the report. Contractor performance reviews and subsequent reports will be used in determining the suitability of contract extension.

2.40 Substitution of Personnel

It is the intention of the City that the Contractor's personnel proposed for the contract will be available for the contract term. In the event the Contractor wishes to substitute personnel, he shall propose personnel of equal or higher qualifications and all replacement personnel are subject to City approval. In the event substitute personnel are not satisfactory to the City and the matter cannot be resolved to the satisfaction of the City, the City reserves the right to cancel the Contract for cause. See Section 5.09 General Conditions.

2.41 Ownership of Work – N/A

2.42 Condition of Trade-In Equipment – N/A

2.43 Conditions of Trade-In Shipment and Purchase Payment – N/A

2.44 Verification of Employment Status

Any Contractor/Consultant assigned to perform responsibilities under its contract with a State agency is required to utilize the US Department of Homeland Security's E-Verify system (per Executive Order Number 11-02) to verify the employment eligibility of: (a) all persons employed during the contract term by the Contractor to perform employment duties within Florida; and (b) all persons (including subcontractors) assigned by the Contractor to perform work pursuant to the contract with the State agency.

E-VERIFY Affirmation Statement (Attachment "A") should be completed and submitted with Proposer's response to this ITB.

2.45 Service Organization Controls – N/A

2.46 Warranties of Usage

Any estimated quantities listed are for information and tabulation purposes only. No warranty or guarantee of quantities needed is given or implied. It is understood that the Contractor will furnish the City's needs as they arise.

2.47 Rules and Submittals of Bids

The signer of the bid must declare that the only person(s), company or parties interested in the proposal as principals are named therein; that the bid is made without collusion with any other person(s), company or parties submitting a bid; that it is in all respects fair and in good faith, without collusion or fraud; and that the signer of the bid has full authority to bind the principal bidder.

2.48 Bid Tabulations/Intent to Award

Notice of Intent to Award Contract/Bid, resulting from the City's Formal solicitation process may be found at: <http://www.fortlauderdale.gov/departments/finance/procurement-services/notices-of-intent-to-award>. Tabulations of receipt of those parties responding to a formal solicitation may be found at: <http://www.fortlauderdale.gov/departments/finance/procurement-services/bid-results>, or any interested party may call the Procurement Services Division at 954-828-5933.

2.49 Public Records

All bids will become the property of the City. The Bidder's response to the ITB is a public record pursuant to Florida law, which is subject to disclosure by the City under the State of Florida Public Records Law, Florida Statutes Chapter 119.07 ("Public Records Law"). The City shall permit public access to all documents, papers, letters or other material submitted in connection with this ITB and any resulting Contract to be executed for this ITB, subject to the provisions of Chapter 119.07 of the Florida Statutes. Any language contained in the Bidder's response to the ITB purporting to require confidentiality of any portion of the Bidder's response to the ITB, except to the extent that certain information is in the City's opinion a Trade Secret pursuant to Florida law, shall be void. If a Bidder submits any documents or other information to the City which the Bidder claims is Trade Secret information and exempt from Florida Statutes Chapter 119.07 ("Public Records Laws"), the Bidder shall clearly designate that it is a Trade Secret and that it is asserting that the document or information is exempt. The Bidder must specifically identify the exemption being claimed under Florida Statutes 119.07. The City shall be the final arbiter of whether any information contained in the Bidder's response to the ITB constitutes a Trade Secret. The city's determination of whether an exemption applies shall be final, and the Bidder agrees to defend, indemnify, and hold harmless the city and the city's officers, employees, and agent, against any loss or damages incurred by any person or entity as a result of the city's treatment of records as public records. In the event of Contract award, all documentation produced as part of the Contract shall become the exclusive property of the City.

IF THE CONTRACTOR HAS QUESTIONS REGARDING THE APPLICATION OF CHAPTER 119, FLORIDA STATUTES, TO THE CONTRACTOR'S DUTY TO PROVIDE PUBLIC RECORDS RELATING TO THIS CONTRACT, CONTACT THE CUSTODIAN OF PUBLIC RECORDS AT PRRCONTRACT@FORTLAUDERDALE.GOV, 954-828-5002, CITY CLERK'S OFFICE, 100 N. ANDREWS AVENUE, FORT LAUDERDALE, FLORIDA 33301.

Contractor shall:

1. Keep and maintain public records required by the City in order to perform the service.
2. Upon request from the City's custodian of public records, provide the City with a copy of the requested records or allow the records to be inspected or copied within a reasonable time at a cost that does not exceed the cost provided in Chapter 119, Florida Statutes (2017), as may be amended or revised, or as otherwise provided by law.
3. Ensure that public records that are exempt or confidential and exempt from public records disclosure requirements are not disclosed except as authorized by law for the duration of the contract term and following completion of this contract if the Contractor does not transfer the records to the City.
4. Upon completion of the Contract, transfer, at no cost, to the City all public records in possession of the Contractor or keep and maintain public records required by the City to perform the service. If the Contractor transfers all public records to the City upon completion of this Contract, the Contractor shall destroy any duplicate public records that are exempt or confidential and exempt from public records disclosure requirements. If the Contractor keeps and maintains public records upon completion of this Contract, the Contractor shall meet all applicable requirements for retaining public records. All records stored electronically

must be provided to the City, upon request from the City's custodian of public records, in a format that is compatible with the information technology systems of the City.

2.50 PCI (Payment Card Industry) Compliance

Contractor agrees to comply with all applicable state, federal and international laws, as well as industry best practices, governing the collection, access, use, disclosure, safeguarding and destruction of protected information.

Contractor and/or any subcontractor that handles credit card data must be, and remain, PCI compliant under the current standards and will provide documentation confirming compliance upon request by the City of Fort Lauderdale, failure to produce documentation could result in termination of the contract.

2.51 Liquidated Damages Provision

Time is of the essence throughout this Contract.

Upon failure of CONTRACTOR to substantially complete work orders within the specified period of time, plus approved time extensions, The City reserves the right to impose liquidated damages on the Contractor.

Failure to complete the project(s) of any Work Order within the reasonable agreed number of working days, shall subject the Contractor to pay Fifty dollars (\$50.00) for each calendar day of the first 30 day period and One hundred (\$100.00) for each calendar day thereafter. These amounts will be applied (subtracted) to the Contractor's pay request for the particular work order. The above-stated liquidated damages shall apply separately to each portion of the project for which a time for completion is given.

It is agreed upon and determined by both parties that the liquidated damages assessed are amounts that the City may reasonably suffer by reason of such default and are not an enforcement of penalty.

END OF SECTION

SECTION III - SCOPE OF SERVICES/TECHNICAL SPECIFICATIONS

3.1 SCOPE OF SERVICES

01. Scope of Work

To furnish all labor, equipment and tools required for the installation and repair of chain link and picket fencing, including required pickup and transport, in accordance with the specifications of this bid. To supply required equipment and labor to remove, haul and properly dispose of any debris or excess fill material as developed during the fulfillment of this contract.

02. Working Hours

The standard work week shall be considered as Monday through Friday, from 7:30 AM through 4:30 PM; excluding normal holidays granted to City employees. Workdays are exclusive of Saturday and Sunday.

Work shall normally be scheduled to commence during the standard workweek hours, however, if both the Contractor and City personnel agree, work can be accomplished during hours other than those detailed as standard workweek hours.

03. Standard Service Requirements

The work consists of furnishing all labor, material, equipment and incidentals necessary for the construction of the contract items indicated, within City streets, rights-of-way and other City-owned property. All work shall be in accordance with the City's CONSTRUCTION STANDARDS AND SPECIFICATIONS, and FLORIDA BUILDING CODE except where stated otherwise herein.

CONTRACTOR IS REQUIRED TO HAVE ONE OF THE FOLLOWING LICENSES:

1. A General Contractors License Approved by The State of Florida
2. A Building Contractors License
3. A Certificate of Competency

When required, the contractor must apply for and obtain a building permit. The contractor will be responsible for all design and drawings as well as permit applications. Contractor will be reimbursed for permit cost.

Work may be authorized by written work/purchase order. A list of employees authorized to direct work, will be provided to the successful bidder upon award.

Suitable barricades and lights shall be placed by the Contractor to protect the public prior to the installation and/or removal of assigned fencing projects and shall remain until the work is completed. Barricades and lights shall be removed as soon as possible thereafter.

Contractor shall be held responsible for any damage, done by him or his subcontractors, agents, etc, to work performed by another Contractor in the assigned work area.

The quantities of work estimated herein are approximations only. The total quantities of work to be included in this contract and actually performed may vary widely and some items may be

completely eliminated depending upon the work that will be authorized by the City during the period of this contract, by field conditions or availability of funds.

The Contractor shall provide the City typed (Excel, Word, or similar) and signed off (by the contractor's project manager/s) as-built field quantities and/or measurements specific to each job, within a maximum period of ten (10) working days after the work is completed. Any pay request submitted to the City by the Contractor shall include this as-built data. Pay requests shall also not exceed a period of (30) working days following each work request completion, as verified by the City.

MAINTENANCE OF TRAFFIC

Contractor shall be responsible for maintaining traffic in accordance with the Florida Department of Transportation standards and all applicable local requirements. Contractor shall be responsible for obtaining all applicable permits for maintenance of traffic.

PROTECTION AND RESTORATION OF SURVEY MONUMENTS

The Contractor shall carefully protect from disturbances all survey monuments, stakes and bench marks, whether or not established by him, or he shall not remove nor destroy any surveying point until it has been properly witnessed or otherwise disposed of by the Engineer. All major survey monuments such as section corners, property corners, or block control points shall be replaced at the Contractor's expense with markers of a size and type approved by the Engineer. The replacement shall be under the supervision of a Florida Registered Land Surveyor.

SURVEYING BENCHMARKS AND CONTROL POINTS, when and where required

The City Surveyor will establish the initial benchmarks, control points, and one set of construction stakes for the median curb, at no charge to the Contractor. The Contractor shall be responsible for requesting the construction stakes at least five working days in advance of when stakes will be needed. The Contractor is responsible to protect and preserve all reference points and stakes established by the City Surveyor. In the event the stakes are damaged or moved, the Contractor shall be responsible for re-establishing the field reference points and stakes at his own expense. The City Surveyor will obtain all as-builts. All requests for survey work shall be directed through the City Engineering Inspector.

04. Emergency Service Requirements

The Contractor shall provide, if requested, temporary fencing within twenty-four (24) hours from initial contact by the City.

05. Contractor's Responsibilities

A. Contractor shall repair or correct any damage caused to underground and/or overhead utilities in the installation and/or repair of fencing, at no additional cost to the City.

B. Contractor shall repair or correct to the satisfaction of the City, any damage to City and/or private property as a result of fence installation and/or repairs, at no additional cost to the City. This includes, but is not limited to, repair to concrete sidewalks or medians.

C. Damage to public and/or private property shall be the responsibility of the Contractor and shall be repaired and/or replaced in a timely fashion at no additional cost to the City.

- D. When removing fencing and not installing replacement fencing, the Contractor shall provide material and labor to backfill the excavation hole to a level even with surrounding grade lines. The Contractor shall be responsible to furnish additional fill if required.
- E. Any fencing material either purchased damaged, or damaged during handling, transporting or installation by the Contractor, shall be replaced at the expense of the Contractor.
- F. Contractor shall haul and dispose of any and all debris or fill developed as a result of removal, installation or repair under this contract, at no additional cost to the City.

06. BID ALLOWANCE of \$45,000

Allowance for Materials: Contractor must include the price of supplies and materials in all required bid line items. Supplies and materials for additional jobs / requests not specifically indicated in the bid line items may be purchased under this contract on a strictly COST-PLUS 5% arrangement, upon written approval by City Staff. Payments will be made to the contractor based on the actual cost of material invoice plus an additional 5% mark-up, upon submission of paid receipts.

The amount indicated is intended to be sufficient to cover the entire contract term.

Allowance	\$
Additional material allowance	\$45,000

Note: The City will add this allowance to your bid. – (for bid tabulation calculation purposes)

3.2 TECHNICAL SPECIFICATIONS

3.2.1 CHAIN LINK FENCE

SECTION A - GENERAL

01. DESCRIPTION

This item shall consist of furnishing and erecting chain-link fencing in accordance with these specifications and the details shown on the plans and in conformity with the lines and grades shown on the plans or established by the Engineer.

02. MATERIALS/FABRIC

The fabric shall be woven with a 9-gauge galvanized steel wire in a 2-inch mesh and shall meet the requirements of ASTM A-392, Class 2.

BARBED WIRE

Barbed wire shall be 2-strand 12-1/2 gauge zinc-coated wire with 4-point barbs and shall conform to the requirements of ASTM A-121, Class 3, chain link fence grade.

POSTS, RAILS AND BRACES

Posts, rails, and braces furnished for use in conjunction with zinc-coated, zinc-5%aluminum mischmetal alloy coated, or aluminum-coated steel fabric shall be of zinc-coated steel, zinc/polymer-coated steel, or zinc-5% aluminum mischmetal alloy coated steel framework. Those furnished for use in conjunction with aluminum alloy fabric shall be aluminum alloy.

Line posts, rails, and braces shall be one of the following:

- Galvanized steel pipe shall conform to the requirements of ASTM F 1083, or
- Roll-formed sections shall be fabricated from material meeting the requirements of ASTM A 570, Grade 45, and shall be galvanized in accordance with the requirements of ASTM F1043, Type A, or coated with zinc 5% aluminum mischmetal alloy in accordance with ASTM F 1043, Type C.

Post, rails, and braces shall demonstrate the ability to withstand testing in salt spray in accordance with ASTM B-117 as follows:

- Exterior: 1,000 hours with a maximum of 5% red rust.
- Interior: 650 hours with a maximum of 5% red rust.

The dimensions of the posts, rails, and braces shall be in accordance with Tables I through VI of Fed. Spec. RR-F-191/3.

GATES

Gate frames shall consist of galvanized steel pipe and shall conform to the specifications for the same material under section POSTS, RAILS AND BRACES. The fabric shall be of the same type material as used in the fence.

WIRE TIES AND TENSION WIRES

Wire ties for use in conjunction with a given type of fabric shall be of the same material and coating weight identified with the fabric type. Tension wire shall be 7-gauge marcelled steel wire with the same coating as the fabric type and shall conform to ASTM A-824.

All material shall conform to Fed. Spec. RR-F-191/4.

MISCELLANEOUS FITTINGS AND HARDWARE

Miscellaneous steel fittings and hardware for use with zinc-coated steel fabric shall be of commercial grade steel or better quality, wrought or cast as appropriate to the article, and sufficient in strength to provide a balanced design when used in conjunction with fabric posts, and wires of the quality specified herein. All steel fittings and hardware shall be protected with a zinc coating applied in conformance with ASTM A-153. Barbed wire support arms shall withstand a load of 250 pounds applied vertically to the outermost end of the arm.

CONCRETE

Concrete shall be of a commercial grade with a minimum 28-day compressive strength of 3,000 psi.

MARKING

Each roll of fabric shall carry a tag showing the kind of base metal (steel, aluminum, or aluminum alloy number), kind of coating, the gauge of the wire, the length of fencing in the roll, and the name of the manufacturer. Posts, wire, and other fittings shall be identified as to manufacturer, kind of base metal (steel, aluminum, or aluminum alloy number), and kind of coating.

03. CONSTRUCTION METHODS/CLEARING FENCE LINE

All trees, brush, stumps, logs, and other debris which would interfere with the proper construction of the fence in the required location shall be removed a minimum width of 2 feet on each side of the fence centerline before starting fencing operations. The cost of removing and disposing of the material shall not constitute a pay item and shall be considered incidental to fence construction.

INSTALLING POSTS

All posts shall be set in concrete at the required dimension and depth and at the spacing shown on the plans.

Posts should be spaced not more than 10 feet apart and should be set a minimum of 36 inches in concrete footings. If the frost depth is greater than 36 inches, the posts should be set accordingly. The posts holes shall be in proper alignment so that there is a minimum of 3 inches of concrete on all sides of the posts.

The concrete shall be thoroughly compacted around the posts by tamping or vibrating and shall have a smooth finish slightly higher than the ground and sloped to drain away from the posts. All posts shall be set plumb and to the required grade and alignment. No materials shall be installed on the posts, nor shall the posts be disturbed in any manner within 7 days after the individual post footing is completed.

Should rock be encountered at a depth less than the planned footing depth, a hole 2 inches larger than the greatest dimension of the posts shall be drilled to a depth of 12 inches. After the posts are set, the remainder of the drilled hole shall be filled with grout, composed of one

part Portland cement and two parts mortar sand. Any remaining space above the rock shall be filled with concrete in the manner described above.

In lieu of drilling, the rock may be excavated to the required footing depth. No extra compensation shall be made for rock excavation.

INSTALLING TOP RAILS

The top rail shall be continuous and shall pass through the post tops. The coupling used to join the top rail lengths shall allow for expansion.

INSTALLING BRACES

Horizontal brace rails, with diagonal truss rods and turnbuckles, shall be installed at all terminal posts.

INSTALLING FABRIC

The wire fabric shall be firmly attached to the posts and braced in the manner shown on the plans. All wire shall be stretched taut and shall be installed to the required elevations. The fence shall generally follow the contour of the ground, with the bottom of the fence fabric no less than 1 inch or more than 4 inches from the ground surface. Grading shall be performed where necessary to provide a neat appearance.

At locations of small natural swales or drainage ditches and where it is not practical to have the fence conform to the general contour of the ground surface, longer posts may be used and multiple strands of barbed wire stretched thereon to span the opening below the fence. The vertical clearance between strands of barbed wire shall be 6 inches or less.

Openings below the fence may also be spanned with barbed wire fastened to stakes.

ELECTRICAL GROUNDS

Electrical grounds shall be constructed at 500-foot intervals. The ground shall be accomplished with a copper clad rod 8 feet long and a minimum of 5/8 inch in diameter driven vertically until the top is 6 inches below the ground surface. A No. 6 solid copper conductor shall be clamped to the rod and to the fence in such a manner that each element of the fence is grounded. Installation of ground rods shall not constitute a pay item and shall be considered incidental to fence construction.

SECTION B - METHOD OF MEASUREMENT

01. Chain-link fence will be measured for payment by the linear foot. Measurement will be along the top of the fence from center to center of end posts, excluding the length occupied by gate openings.

SECTION C - BASIS OF PAYMENT

01. Payment for chain-link fence will be made at the contract unit price per linear foot.

Payment for driveway or walkway gates will be made at the contract unit price for each gate.

The price shall be full compensation for furnishing all materials, supplies, labor and all other requirements and incidentals, and for all preparation, erection, and installation of these materials, and for all labor equipment, tools, and incidentals necessary to complete the item.

3.2.2 CHAIN-LINK CANTILEVER SLIDE GATES

SECTION A - GENERAL

01. SECTION INCLUDES

This section shall consist of furnishing and erecting chain link cantilever slide gate(s) with all necessary accessories and hardware in accordance with these specifications and the details shown on the plans and in conformity with the lines and grades shown on the plans or established by the Engineer.

02. MATERIALS FABRIC

The fabric shall be woven with a 9-gauge galvanized steel wire in a 2-inch mesh and shall meet the requirements of ASTM A-392, Class 2.

BARBED WIRE

Barbed wire shall be 2-strand 12-1/2 gauge zinc-coated wire with 4-point barbs and shall conform to the requirements of ASTM A-121, Class 3, chain link fence grade.

POSTS, RAILS AND BRACES

Posts, rails, and braces furnished for use in conjunction with zinc-coated, zinc-5% aluminum mischmetal alloy coated, or aluminum-coated steel fabric shall be of zinc-coated steel, zinc/polymer-coated steel, or zinc-5% aluminum mischmetal alloy coated steel framework. Those furnished for use in conjunction with aluminum alloy fabric shall be aluminum alloy.

Support and latch posts, rails, and braces shall be galvanized steel pipe conforming to the requirements of ASTM F-1083.

Post, rails, and braces shall demonstrate the ability to withstand testing in salt spray in accordance with ASTM B-117 as follows:

- Exterior: 1,000 hours with a maximum of 5% red rust.
- Interior: 650 hours with a maximum of 5% red rust.

CANTILEVER ROLLERS

Cantilever rollers are to be constructed of hot dipped galvanized steel and equipped with grease fittings. The cantilever rollers are to be 4" x 2.5" in size. Each roller shall be equipped with a cantilever roller cover that is of steel construction and epoxy coated.

GATE FRAME

Gate frames shall consist of galvanized steel pipe and shall conform to the specifications for the same material under paragraph 162-2.3 of the CHAIN LINK FENCES specifications. The fabric shall be of the same type material as used in the fence.

WIRE TIES AND TENSION WIRES

Wire ties for use in conjunction with a given type of fabric shall be of the same material and coating weight identified with the fabric type. Tension wire shall be 7-gauge marcelled steel wire

with the same coating as the fabric type and shall conform to ASTM A-824.

All material shall conform to Fed. Spec. RR-F-191/4.

MISCELLANEOUS FITTINGS AND HARDWARE

Miscellaneous steel fittings and hardware for use with zinc-coated steel fabric shall be of commercial grade steel or better quality, wrought or cast as appropriate to the article, and sufficient in strength to provide a balanced design when used in conjunction with fabric posts, and wires of the quality specified herein. All steel fittings and hardware shall be protected with a zinc coating applied in conformance with ASTM A-153. Barbed wire support arms shall withstand a load of 250 pounds applied vertically to the outermost end of the arm.

CONCRETE

Concrete shall be of a commercial grade with a minimum 28-day compressive strength of 3,000 psi.

MARKING

Each roll of fabric shall carry a tag showing the kind of base metal (steel, aluminum, or aluminum alloy number), kind of coating, the gauge of the wire, the length of fencing in the roll, and the name of the manufacturer. Posts, wire, and other fittings shall be identified as to manufacturer, kind of base metal (steel, aluminum, or aluminum alloy number), and kind of coating.

SECTION B - PRODUCTS

01. MANUFACTURER

A. Products from qualified manufacturers having a minimum of 3 years experience manufacturing internal roller cantilever slide gate will be acceptable by the Engineer as equal, if approved in writing, ten days prior to bidding, and if they meet all of the following specifications for design, size gauge of metal parts and fabrication.

B. Obtain gates, including accessories, fittings, and fastenings, from a single source.

02. CHAIN LINK CANTILEVER SLIDE GATES

A. Gate frames: Cantilever Slide Gate Frame shall conform to FDOT Index 453. Steel gate frame shall be fabricated prior to galvanizing, except that truss rods may be fabricated following frame galvanizing provided surfaces damaged during welding are galvanized in accordance with Section 24 of AASHTO M36; or, fabricated from pipe components with protective coating meeting the requirements of FDOT Index 452 that are tolerant of welding (low burn back), and a protective coating applied to the weld and damaged pipe surfaces that is equivalent to the protective coating of the fabricated pipe stock.

B.	Gate Opening	Gate Frame	Back Frame
	14'	14'-3"	6'
	16'	16'-3"	8'
	20'	20'-3"	10'

C. Bracing: Provide diagonal adjustable length truss rods of 3/8" galvanized steel, in each panel of gate frame.

- D. Gate hangers, latches, brackets, guide assemblies, and stops: Malleable iron or steel, galvanized after fabrication. Provide positive latch with provisions for padlocking.
- E. Top and Bottom guide wheel assemblies: Each assembly shall consist of two top and two bottom guide wheel assemblies, 4-inch diameter hot dipped galvanized steel wheels, straddling top and bottom horizontal gate rail, allowing adjustment to maintain gate frame plumb and in proper alignment. Attach top and bottom guide wheel assemblies to each support guidepost.
- F. Support guideposts: Provide two support guideposts. Support posts are galvanized steel 4" OD schedule 40 pipe, ASTM F-1083, weighing 9.1 lb/ft.
- G. Latch Post: Provide one latch post. Latch post is galvanized steel 3" OD schedule 40 pipe, ASTM F-1083, weighing 5.79 lb/ft.
 - 1. Finish to match fence.

SECTION C - EXECUTION

01. EXAMINATION

- A. Verify areas to receive gate is completed to final grades and elevations.
- B. Verify areas to assure sufficient space to receive gate in open position, (gate and overhang.)
- C. Ensure property lines and legal boundaries of work are clearly established.

02. CHAIN LINK CANTILEVER SLIDE GATE FRAMING INSTALLATION

- A. Install gateposts in accordance with manufacturer's instructions.
- B. Concrete set gateposts: Drill holes in firm, undisturbed or compacted soil. Holes shall have diameter 18", and depths approximately 6" (152 mm) inches deeper than post bottom. Excavate deeper as required for adequate support in soft and loose soils, and for posts with heavy lateral loads. Set post bottom 3'-6" below surface when in firm, undisturbed soil. Place concrete around posts in a continuous pour, tamp for consolidation. Trowel finish around post and slope to direct water away from posts. Check each post for vertical and top alignment and maintain in position during placement and finishing operations.

03. GATE INSTALLATION

- A. Install gates plumb, level, and secure for full opening without interference.
- B. Attach hardware by means that will prevent unauthorized removal.
- C. Adjust hardware for smooth operation.

04. CLEANING

- A. Clean up debris and unused material and remove from the site.

SECTION D - METHOD OF MEASUREMENT

01. Chain link cantilevered slide gates will be measured as complete units installed.

SECTION E - BASIS OF PAYMENT

01. Payment for chain link cantilevered slide gates will be made at the contract unit price for each slide gate installed.

The price shall be full compensation for furnishing all materials, and for preparation, erection, and installation of these materials, and for all labor, equipment, tools, and incidentals necessary to complete the item.

3.2.3 BOX FRAME CANTILEVER SLIDE GATES

SECTION A - GENERAL

01. SECTION INCLUDES

This section shall consist of furnishing all labor, materials, inspections, supervision, etc., necessary for the complete installation and operation of aluminum cantilever slide gate(s) as shown on the plans and specified herein and in conformity with the lines and grades shown on the plans or established by the Engineer.

02. MATERIALS

- A. The specified gate shall be fabricated from 6061-T6 or 6063-T6 aluminum alloy extrusions.
 - 1) Gate frame primary members (top and bottom) shall be fabricated from a shaped cross section member with no less than 2" on a side wide, weighing no less than 0.97 lbs/ft., and welded at frame corners so as to form a rigid unit.
 - 2) A framework of square tubing connecting the opposing gate faces and maintaining them in proper suspension and tension shall accomplish the essential box frame format. Connecting members shall be consistent with manufacture's specifications.
 - 3) Frame shall be fabricated to form a rigid box construction constructed with the width between the frames not to exceed 24".
 - 4) Intermediate vertical members shall consist of square tubing at a spacing not to exceed the overall height of the box frame. Vertical members shall be consistent with manufacture's specifications.
- B. Gate frames shall include diagonal cross-bracing of a minimum 3/16" diameter stainless steel aircraft cable installed in the vertical plane through the gate proper and the counterbalance to allow for upward or downward vertical cord adjustment throughout the gate, and to add further rigidity to the gate frame.
- C. The gate frame shall be fabricated in modular sections or in single units depending on size constraints then shop or field assembled for the specified opening.
- D. The gate frame shall have a separately extruded pair of enclosed tracks, of 6063-T6 or 6105-T5 aluminum alloy attached by factory welding. The tracks shall be constructed per standard manufacture's specifications.
 - 1) The tracks shall be affixed in parallel positions to the upper frame on opposing sides.
- E. The gate frame shall be supported from within the twin tracks by four (4) self-aligning, swivel ball-and-socket type truck assemblies having rubber-sealed lubricant ball bearing wheels.

- 1) The truck assembly wheels shall be 2" in diameter by 9/16" in width and have an extended dynamic load rating of 4,000 pounds each.
 - 2) Two side-rolling guide wheels affixed to each truck shall be provided to ensure alignment of the trucks within the tracks
- F. A bottom guide assembly, consisting of a bracket to which one 3" to 3-1/2" diameter wheels shall be attached, shall be provided for each of the four gate erection posts. Bottom guide assemblies shall be attached to the posts and adjusted to maintain the gate in a plumb state by causing the gate to pass between the bottom guide wheel pairs.
- G. Drive rail shall be extruded 6061-T6 aluminum not less than 1/8" thick.
- H. A receiver latch/catch assembly with padlocking provisions shall be supplied.
- I. Chain link fabric shall be woven with be a 9-gauge galvanized steel wire in a 2-inch mesh and shall meet the requirements of ASTM-A-392, Class 2. Chain link fabric shall be installed within the vertical and horizontal members by means of fabric clips, adding rigidity to the gate frame.
- J. Barbed Wire shall be 2-stranded 12-1/2 gauge zinc-coated wire with 4-point barbs and shall conform to requirements of ASTM A-392, Class 2.
- K. Double support posts shall be 4" O.D. galvanized steel with concrete footings per plans.
- L. Concrete shall be of a commercial grade with a minimum 28-day compressive strength of 3,000 psi.

03. SPECIAL WARRANTY

Provide manufacturer's limited warranty covering aluminum cantilever slide gate and accessories against failure resulting from normal use for period of 5 years from date of purchase. Failure is defined as any defect in manufacturing that prevents the gate from operating in a normal manner.

SECTION B - PRODUCTS

01. QUALITY ASSURANCE

- A. Manufacturer: Products from qualified manufacturer having a minimum of three (3) years' experience manufacturing box-frame cantilever slide gates of this magnitude. The manufacturer shall provide certification of factory pre-hanging, adjustment, testing of gate, and results of draw-force testing as quality assurance that the gate shall be hung plumb and straight and could be actuated as designed and specified at the time of manufacture, and that the gate has been tested and found to comply with ASTM F1184.
- 1) Manufacturer shall provide certification of compliance with all applicable laws of domesticity.
 - 2) Obtain chain link fences and gates, including accessories, fittings, and fastenings, from a single source.
- B. Installer: The installer shall have a minimum of three (3) years installation experience of similar equipment.
- C. Procure all necessary and usual inspections and certificates for all work to be installed. Deliver same to Owner/Owners representative before final acceptance.

SECTION C - EXECUTION

01. EXAMINATION

- A. Verify areas to receive gate are completed to final grades and elevations.
- B. Verify areas to assure sufficient space to receive gate in open position, (gate and overhang.)

C. Ensure property lines and legal boundaries of work are clearly established.

02. **BOX FRAME CANTILEVER SLIDE GATE INSTALLATION**

- A. Install gate and gateposts in accordance with manufacturer's instructions.
- B. Concrete set gateposts: Drill holes in firm, undisturbed or compacted soil. Holes shall be in accordance with manufacture's specifications and depths approximately 6" inches deeper than post bottom. Excavate deeper as required for adequate support in soft and loose soils, and for posts with heavy lateral loads. Set post bottom 36" below surface when in firm, undisturbed soil. Place concrete around posts in a continuous pour, tamp for consolidation. Trowel finish around post and slope to direct water away from posts. Check each post for vertical and top alignment and maintain in position during placement and finishing operations.
- C. Excavate, place concrete and install four (4) 4"OD schedule 40 galvanized steel posts welded into sets, with a third post or double-post set of 4"OD to be installed for the gate stop. Secure posts in footings as detailed and in accordance with the appropriate drawings.
 - 1). Install hanger brackets and guide roller assemblies attach truck assemblies to hangers and make final adjustments to align gate with latch.
- D. The gate and installation shall conform to ASTM F-1184 standards for aluminum cantilever slide gates, Type II, Class 2.
- E. Install gates plumb, level, and secure for full opening without interference.
- F. Attach hardware by means that will prevent unauthorized removal.
- G. Adjust hardware for smooth operation.

03. **FIELD QUALITY CONTROL**

- A. Test gate in conjunction with operator through ten full cycles and adjust for operation without binding, scraping, or uneven motion.
- B. Test gate in various safety detection conditions to confirm loop detection and photo beam devices work as anticipated. Confirm with Airport Operations and Field Inspector that adequate safety test conditions have been met.

04. **CLEANING**

Clean up debris and unused material and remove from the site.

SECTION D - METHOD OF MEASUREMENT

- 01. Aluminum cantilevered slide gates will be measured as complete units installed.

SECTION E - BASIS OF PAYMENT

- 01. Payment for aluminum cantilevered slide gates will be made at the contract unit price for each slide gate installed or repaired.

The price shall be full compensation for furnishing all materials, and for preparation, erection, and installation of these materials, and for all labor, equipment, tools, and incidentals necessary to complete the item.

3.2.4 PVC COATED CHAIN LINK FENCE AND GATES

SECTION A - GENERAL

- 01. INCLUDED IN THIS SECTION

This section shall consist of furnishing all labor, equipment and materials and in performing all

operations necessary for installing a Polyvinyl Coated (PVC) chain link fence and accessories in accordance with these specifications and details as indicated on drawing files.

02. QUALITY ASSURANCE

- A. Chain link fencing shall be manufactured in accordance with the requirements of the Chain Link Fence Manufacturers Institute (CLFMI) Product Manual.
- B. Fence manufacturer shall have at least three (3) years of experience in the manufacture of vinyl-coated steel chain link fencing. The fence fabric, posts, gates, and all hardware shall be manufactured and supplied by a single manufacturer, to insure compatibility of all the fence elements and to define a single source responsibility.
- C. Installer shall have a minimum three (3) years installation experience of chain link fencing.
- D. Procure all necessary and usual inspections and certificates for all work to be installed. Deliver same to Owner/Owner representative before final acceptance.

03. SUBMITTALS

- A. Shop Drawings: Show fence layout, colors of PVC coated, post locations, gates, details illustrating fence height, gate width, size of posts, rails, braces, fittings, and hardware.
- B. Product Data: Submit catalog cuts and manufacturer's detail specifications.

04. WARRANTY

- A. Vinyl coated chain link fence systems shall be supplied with minimum ten (10) year factory warranty.

SECTION B - PRODUCTS

01. GENERAL

Dimensions indicated for pipe are outside dimensions, exclusive of coatings.

02. FENCE FABRIC

- A. Fabric shall be PVC coated thermally fused and bonded to a primer which is thermally cured onto galvanized steel core wire conforming to ASTM F 668, Class 2. Minimum coating thickness shall be 0.007 in.
- B. Fabric shall be woven into 2 in. mesh of 9-gauge galvanized wire core with a minimum breaking strength of 1,290 lbs./ft. in accordance with ASTM F 668, Class 2. Coated wire size shall be 8 gauge (0.165 in.). Other gauges may be required as noted on the plans.
- C. Zinc for galvanized coating shall conform to ASTM b 6, galvanized by hot dipped method AISI Type 1, before vinyl coating; coating shall be smooth. Minimum weight of zinc coating shall be 1.2 oz. per sq. ft. (0.30 oz./ft.).
- D. Polyvinyl chloride coating shall meet the following requirements:
 - 1. Specific gravity shall be 1.30 maximum, tested in accordance with ASTM D 792.

2. Hardness shall be a minimum Durometer reading of A 95 in accordance with ASTM D 2240. Ultimate elongation shall be 275% in accordance with ASTM D 412.
3. Tensile strength shall have a test minimum of 3,300 p.s.i. in accordance with ASTM D 412.
4. Vinyl shall be a dense and impervious covering free of voids, having a smooth, lustrous surface without pinholes, bubbles, voids, or rough or blistered surface.
5. Fabric shall be knuckled at bottom selvage and twisted at top selvage.

E. Fence fabric color shall be black.

03. FENCE POSTS, RAILS, BRACES, GATES, HARDWARE, AND ACCESSORIES
Except for Barbed Wire and Tension Wire the steel requirements stated under ITEM F-162 (CHAIN LINK FENCES) apply for Rails, Posts, Braces, Gates, Hardware and Accessories

also

applies for the PVC coated chain link fence materials.

04. TENSION WIRE
PVC-Coated Tension Wire shall be manufactured in accordance with ASTM 1664, which requires a heavy-duty 7-gauge, 0.177-inch metallic coated core wire having a breaking strength of 1,950 lbf. The PVC coating shall be Class 2 fused and bonded to metallic-coated steel wire.

05. BARBED WIRE
PVC-Coated Barbed Wire shall be manufactured in accordance with ASTM F 1665 which requires 2 strands of 14-gauge, 0.08 inch metallic coated core wire with four-point 14-gauge, 0.08 inch zinc coated barbs. The PVC coating shall be Class 2 fused and bonded to metallic-coated steel wire.

06. WIRE TIES
WIRE TIES: 11-ga. Galvanized steel or 11 ga. Aluminum wire, to match fabric core material.

07. CONCRETE
The concrete shall be commercial grade with a minimum 28-day compressive strength of 3,0000 p.s.i.

08. MARKING
Each roll of fabric shall carry a tag showing the kind of base metal (steel, aluminum, or aluminum alloy number), kind of coating, the gauge of the wire, the length of fencing in the roll, and the name of the manufacturer. Posts, wire, and other fittings shall be identified as to manufacturer, kind of base metal (steel, aluminum, or aluminum alloy number), and kind of coating.

SECTION C - EXECUTION

01. INSTALLATION
A. CLEARING FENCE LINE

All trees, brush, stumps, logs, and other debris which would interfere with the proper construction of the fence in the required location shall be removed a minimum width of 2 feet on each side of the fence centerline before starting fencing operations. The cost of removing and disposing of the material shall not constitute a pay item and shall be considered incidental to fence construction.

B. INSTALLING POSTS

All posts shall be set in concrete at the required dimension and depth and at the spacing shown on the plans.

Posts should be spaced not more than 10 feet apart and should be set a minimum of 36 inches in concrete footings. If the frost depth is greater than 36 inches, the posts should be set accordingly. The posts holes shall be in proper alignment so that there is a minimum of 3 inches of concrete on all sides of the posts.

The concrete shall be thoroughly compacted around the posts by tamping or vibrating and shall have a smooth finish slightly higher than the ground and sloped to drain away from the posts. All posts shall be set plumb and to the required grade and alignment. No materials shall be installed on the posts, nor shall the posts be disturbed in any manner within 7 days after the individual post footing is completed.

Should rock be encountered at a depth less than the planned footing depth, a hole 2 inches larger than the greatest dimension of the posts shall be drilled to a depth of 12 inches. After the posts are set, the remainder of the drilled hole shall be filled with grout, composed of one-part Portland cement and two parts mortar sand. Any remaining space above the rock shall be filled with concrete in the manner described above.

In lieu of drilling, the rock may be excavated to the required footing depth. No extra compensation shall be made for rock excavation.

C. INSTALLING TOP RAILS

The top rail shall be continuous and shall pass through the post tops. The coupling used to join the top rail lengths shall allow for expansion.

D. INSTALLING BRACES

Horizontal brace rails, with diagonal truss rods and turnbuckles, shall be installed at all terminal posts.

E. INSTALLING FABRIC

The wire fabric shall be firmly attached to the posts and braced in the manner shown on the plans. All wire shall be stretched taut and shall be installed to the required elevations. The fence shall generally follow the contour of the ground, with the bottom of the fence fabric no less than 1 inch or more than 4 inches from the ground surface. Grading shall be performed where necessary to provide a neat appearance.

At locations of small natural swales or drainage ditches and where it is not practical to have the fence conform to the general contour of the ground surface, longer posts may be used and multiple strands of barbed wire stretched thereon to span the opening

below the fence. The vertical clearance between strands of barbed wire shall be 6 inches or less.

Openings below the fence may also be spanned with barbed wire fastened to stakes.

F. ELECTRICAL GROUNDS

Electrical grounds shall be constructed at 500-foot intervals. The ground shall be accomplished with a copper clad rod 8 feet long and a minimum of 5/8 inch in diameter driven vertically until the top is 6 inches below the ground surface. A No. 6 solid copper conductor shall be clamped to the rod and to the fence in such a manner that each element of the fence is grounded. Installation of ground rods shall not constitute a pay item and shall be considered incidental to fence construction.

G. TOUCH UP

1. Following installation, scratches and marred spots in galvanized surfaces shall be power wire brushed and painted with a cold-applied galvanized paint at a rate of 2 oz. zinc per sq. ft. of surface.
2. Following installation scratches and marred spots in vinyl-coated surfaces shall be field coated with a vinyl coating supplied by the fence manufacturer.

H. CLEANING

Clean up debris and unused material and remove from site.

SECTION D - METHOD OF MEASUREMENT

01. PVC Coated Chain-link fence will be measured for payment by the linear foot. Measurement will be along the top of the fence from center to center of end posts, excluding the length occupied by gate openings.

Gates will be measured as complete units.

SECTION E - BASIS OF PAYMENT

01. Payment for PVC coated chain-link fence will be made at the contract unit price per linear foot.

Payment for driveway or walkway gates will be made at the contract unit price for each gate.

The price shall be full compensation for furnishing all materials, and for all preparation, erection, and installation of these materials, and for all labor equipment, tools, and incidentals necessary to complete the item.

3.2.5 STEEL TUBULAR PICKETS

SECTION A - GENERAL

01. INCLUDED IN THIS SECTION

This section shall consist of furnishing all labor, equipment and materials and in performing all operations necessary for installing tubular picket ornamental fence systems. The purpose is to

define minimum procedures for the installation of tubular ornamental metal fence systems.

02. MATERIALS

- A. Steel material for tubular picket ornamental fence shall conform to specifications A500 or A501 and have a minimum yield strength of 45,000 PSI
- B. Powder coatings applied to the exterior surface of fence components shall be polymer material
- C. Wet coatings applied to the exterior surface shall be a two-coat paint application system; Primer and top-coat with a minimum thickness of 2 mils.
- D. Fittings, fasteners, and decorative accessories shall be manufactured with material and finish coating that meets the same protective coating performance requirements as required for panels and posts.

03. PICKETS, RAIL, AND POST SIZES

- A. Pickets 3/4 inch x 3/4 inch - 16 Gauge
- B. Rail 1 3/16 inch x 1 1/2 inch – 14 Gauge
- C. Post 2 1/2 inch x 2 1/2 inch – 14 Gauge
- D. Fence Height and space are typical at 6 feet, 8 feet, and 10 feet and must meet current local codes. Some applications like at the south beach parking lot but isn't limited to that area, requires a 3 feet tall picket fence
- E. Fences around pools shall meet pool safety standards and meet current local codes
- F. The spacing between pickets shall be 4 inches or less or meet Code requirements for the particular fence being installed. Local Code requirements supersedes any part of this section and shall prevail if different.

SECTION B - INSTALLATION

- A. All posts shall be set in concrete at the required dimension and depth and at the typical spacing of 10 feet. Posts should be spaced not more than 10 feet apart and should be set a minimum of 36 inches in concrete footings. All posts shall be set according to local Codes. The posts holes shall be in proper alignment so that there is a minimum of 3 inches of concrete on all sides of the posts.

3.2.6 POLY VINYL CHLORIDE (PVC) FENCING

SECTION A – GENERAL

PVC fence shall be either a solid 6 feet high by 8 feet wide tongue and groove privacy fence with flat post caps or a solid 8 feet high by 8 feet wide tongue and groove privacy fence and the color shall be white unless otherwise specified by the Facilities Manager or his designee. All materials must meet ASTM F964-13 standards. Boards shall be 6 inches wide by 7/8 inch thick. Top and bottom rails must be 1 1/2 inch by 5 1/2 inch.

3.2.7 Material Requirements

ASTM A-121	Zinc-Coated (Galvanized) Steel Barbed Wire.
ASTM A-123	Zinc (Hot Galvanized) Coatings on Products Fabricated from Rolled, Pressed, and Forged Steel Shapes, Plates, Bars, and Strip.
ASTM A-153	Zinc Coating (Hot-Dip) on Iron and Steel Hardware.
ASTM A-392	Zinc-Coated Steel Chain-Link Fence Fabric.
ASTM A-446	Specification for Steel Sheet, Zinc-Coated (Galvanized) by the Hot-Dip Process, Structural (Physical) Quality.
ASTM A-491	Aluminum-Coated Steel Chain-Link Fence Fabric.
ASTM A-569	Steel, Carbon (0.15 Maximum, Percent), Hot Rolled Sheet and Strip Commercial Quality.
ASTM A-570	Hot-Rolled Carbon Steel Sheet and Strip Structural Quality.
ASTM A-572	High-Strength Low-Alloy Columbium-Vanadium Steels of Structural Quality.
ASTM A-585	Aluminum-Coated Steel Barbed Wire.
ASTM A-824	Metallic-Coated Steel Marcellled Tension Wire for Use With Chain Link Fence.
ASTM B-117	Standard Test Method of Salt Spray (Fog) Testing.
ASTM B-221	Aluminum-Alloy Extruded Bars, Rods, Wire Shapes and Tubes.
ASTM F-668	Poly (vinyl Chloride)(PVC)-Coated Steel Chain-Link Fence.
ASTM F-1083	Pipe, Steel, Hot-Dipped Zinc-coated (galvanized) Welded, for Fence Structures.
ASTM F-1183	Aluminum Alloy Chain Link Fence Fabric.
ASTM F-1234	Protective Coatings on Steel Framework for Fences.
Fed. Spec. RR-F-191/3	Fencing, Wire and Post, Metal (Chain-Link Fence Posts, Top Rails and Braces).
Fed. Spec. RR-F-191/4	Fencing, Wire and Post, Metal (Chain-Link Fence Accessories).

END OF SECTION

11043-001-0030E1.dwg Tue Dec 27 2005 - 2:12p Alionic

PROJECT #(SERV. CONT.)
ANNUAL CHAIN-LINK &
REPAIR SERVICE CONTRACT
& GATE DETAILS

NO.	DATE	BY	CHKD	DESCRIPTION

CITY OF FORT LAUDERDALE
PUBLIC WORKS DEPARTMENT
ENGINEERING DIVISION
FORT LAUDERDALE, FLORIDA

DRAWN BY: A.C. N.T.S.
DESIGNED BY: S.N. DATE: 12/27/05
CHECKED BY: FIELD BOOK: 0
FLA. REG. ENG. NO. 48266
KARIM RAHMANKHAH
FINAL APPROVAL

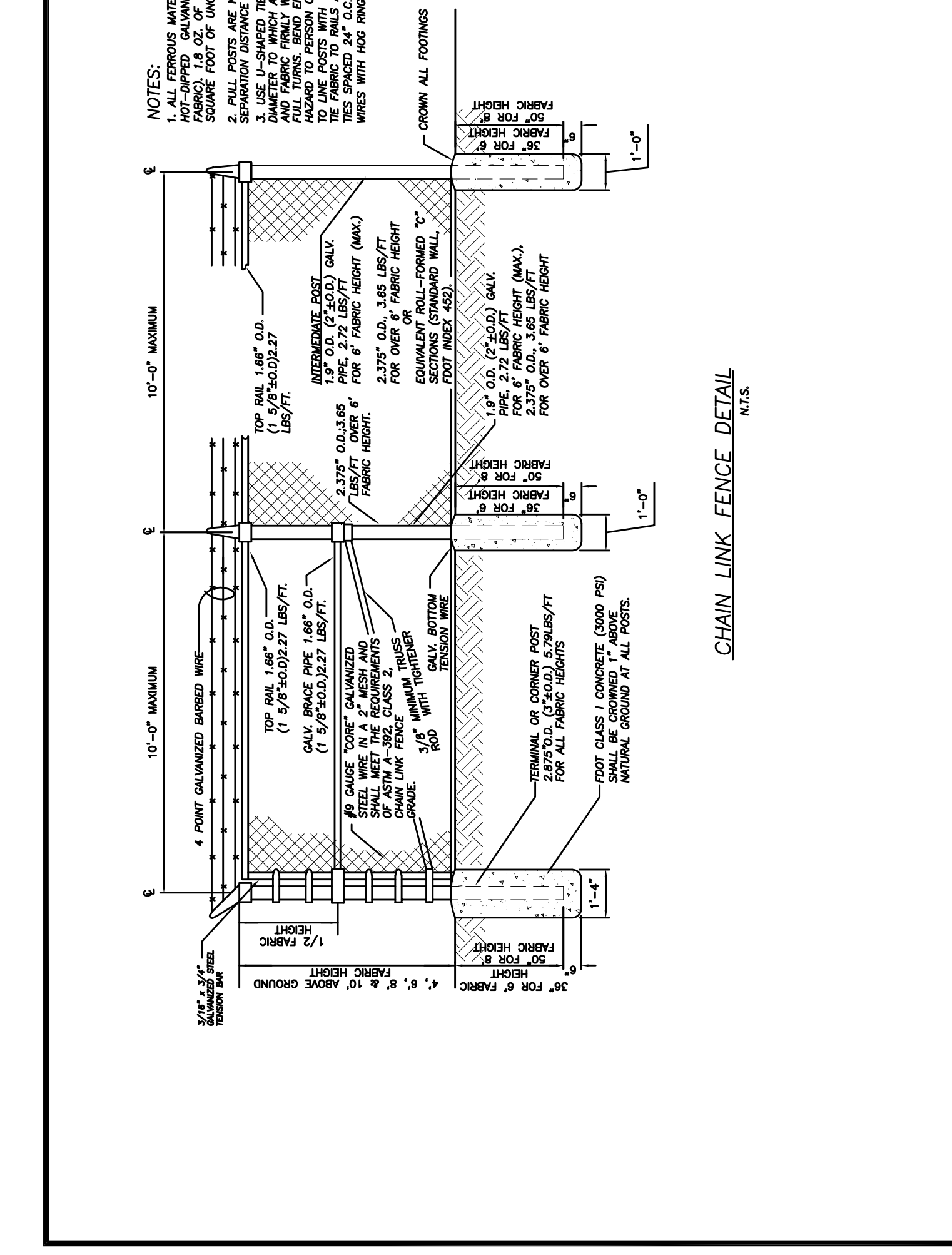
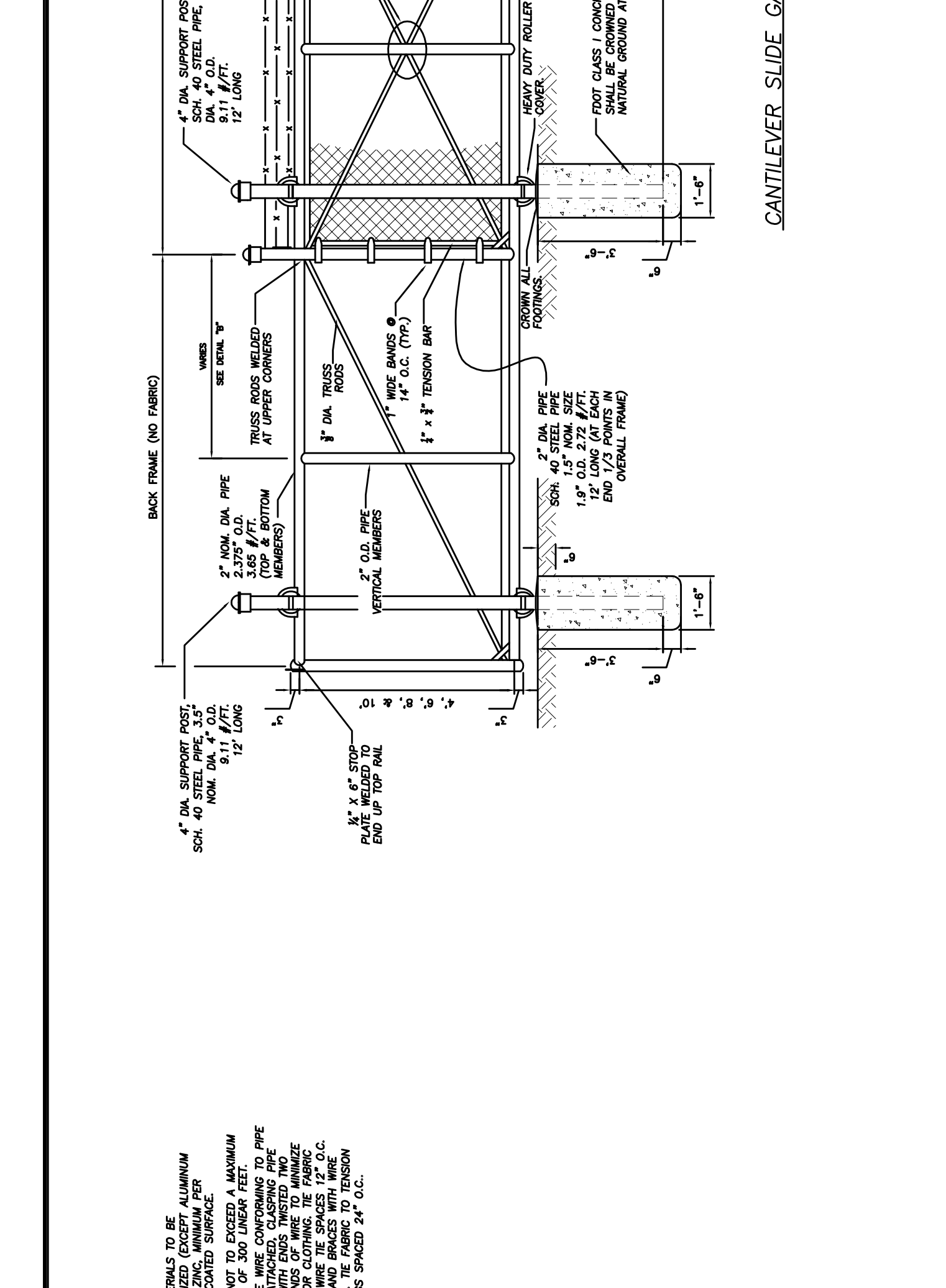
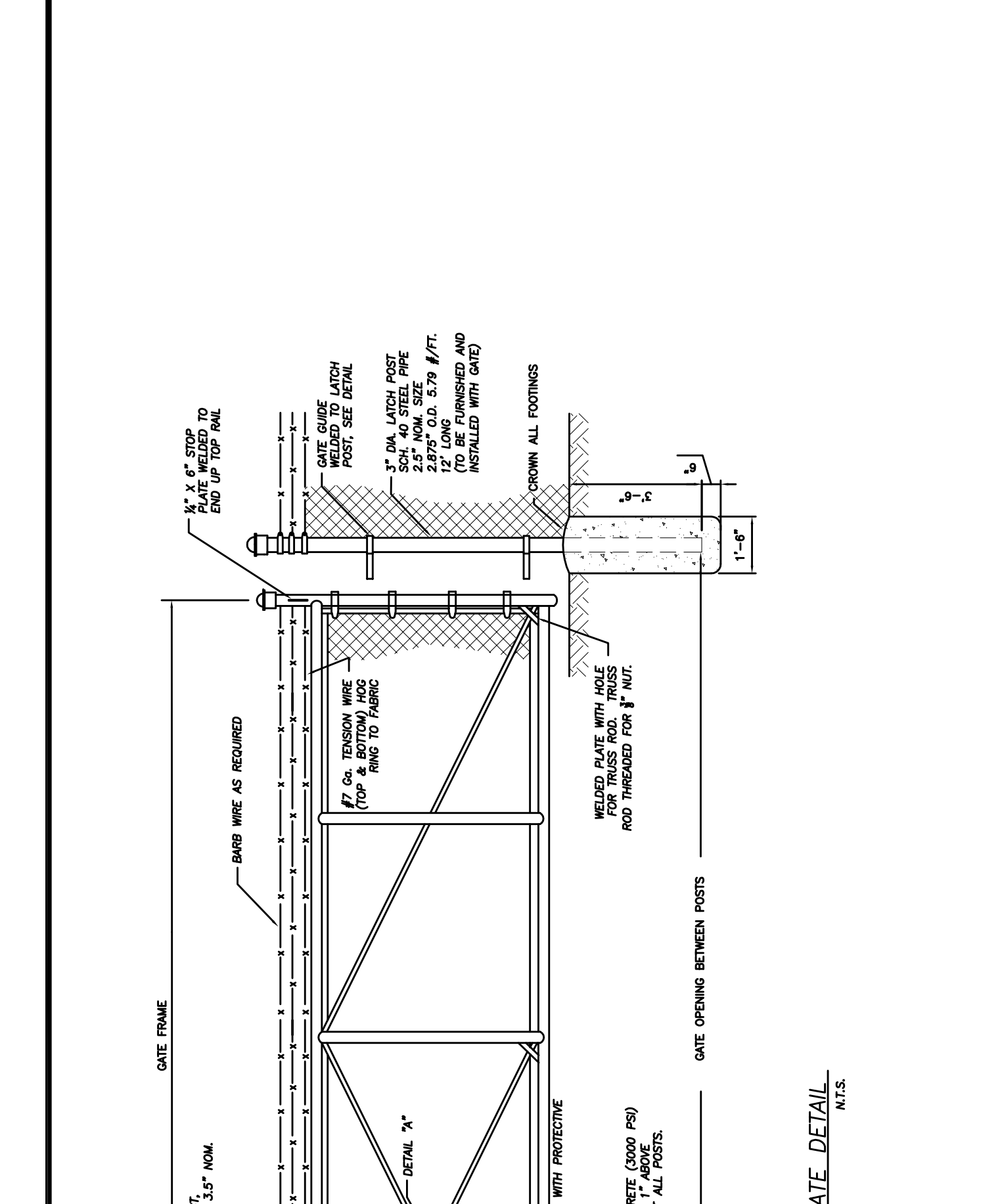
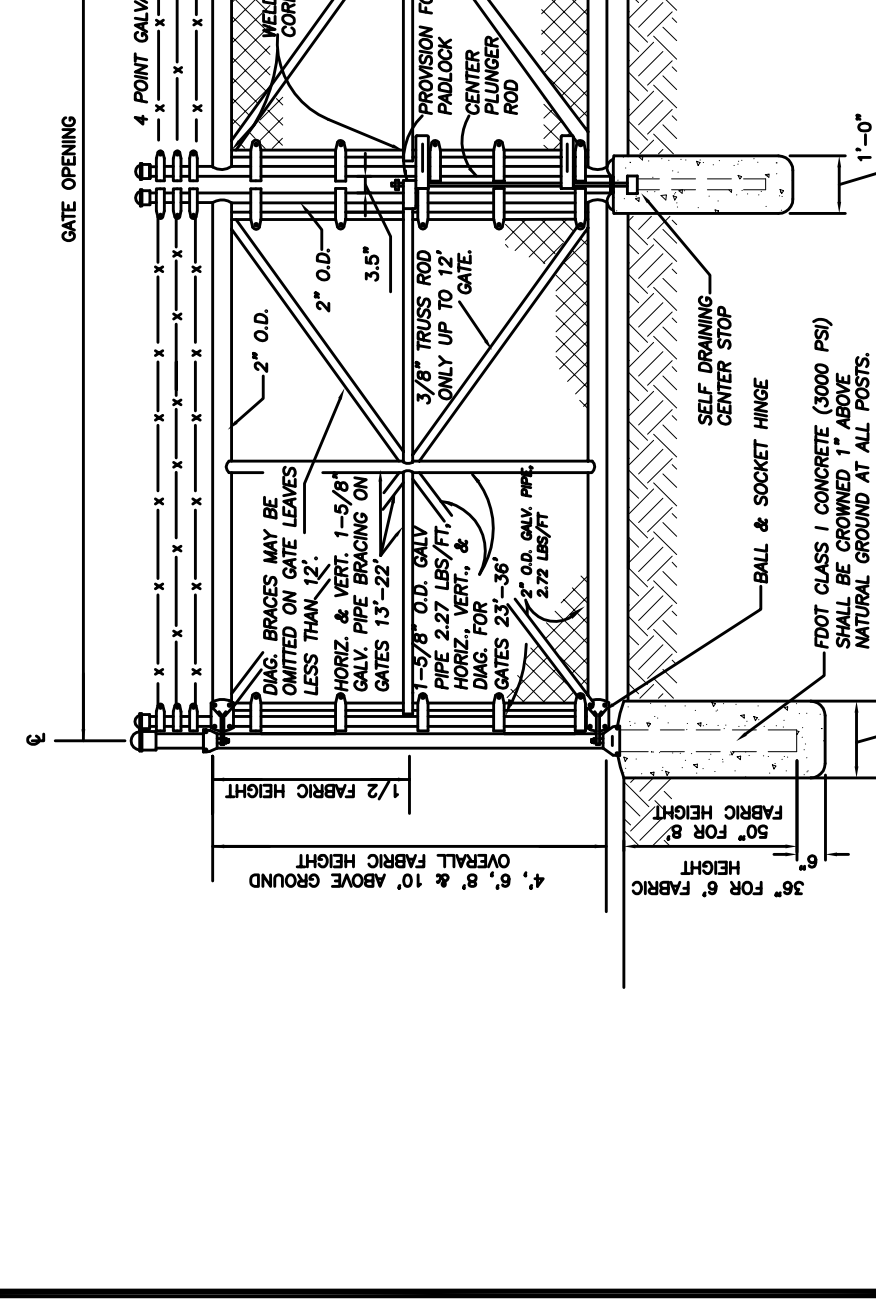
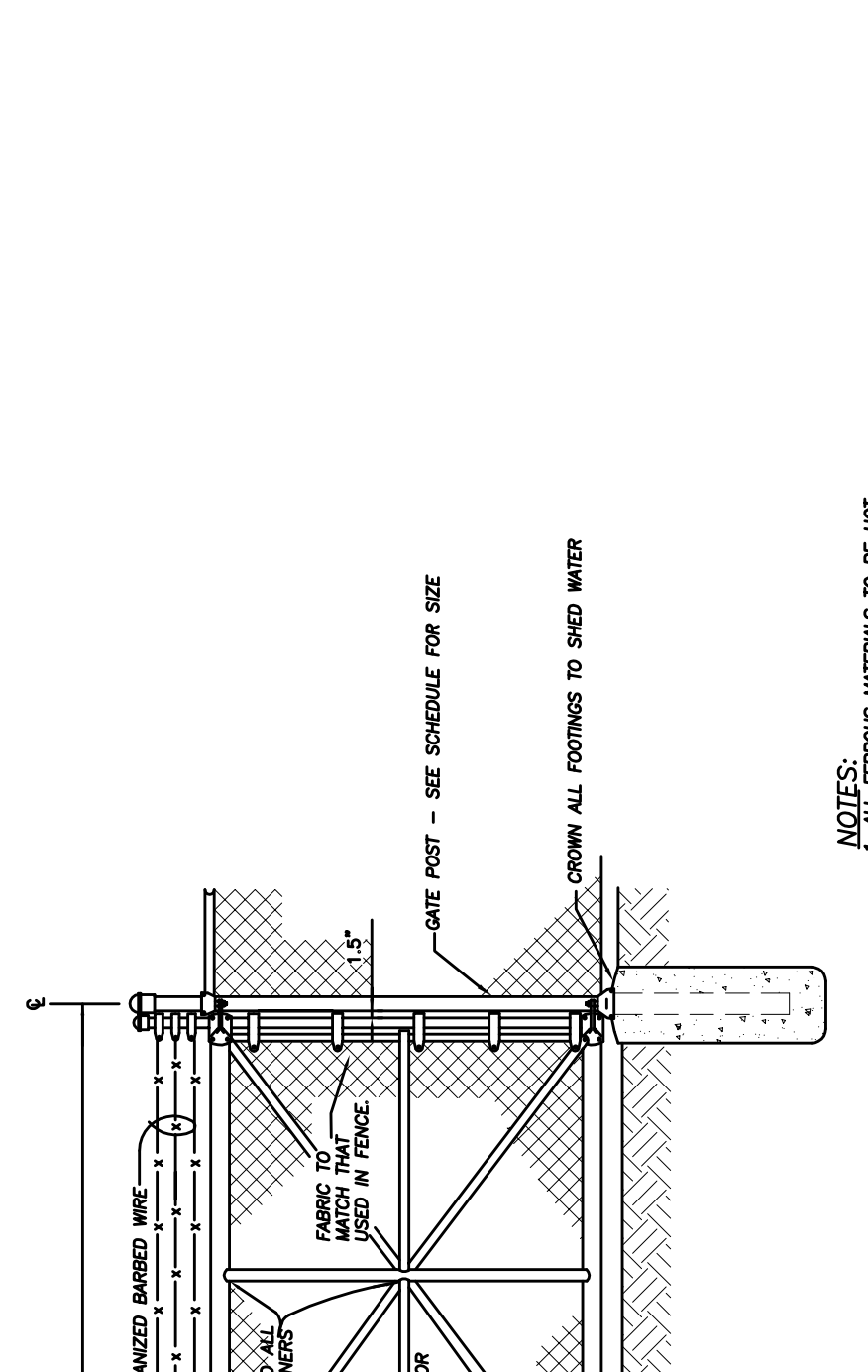
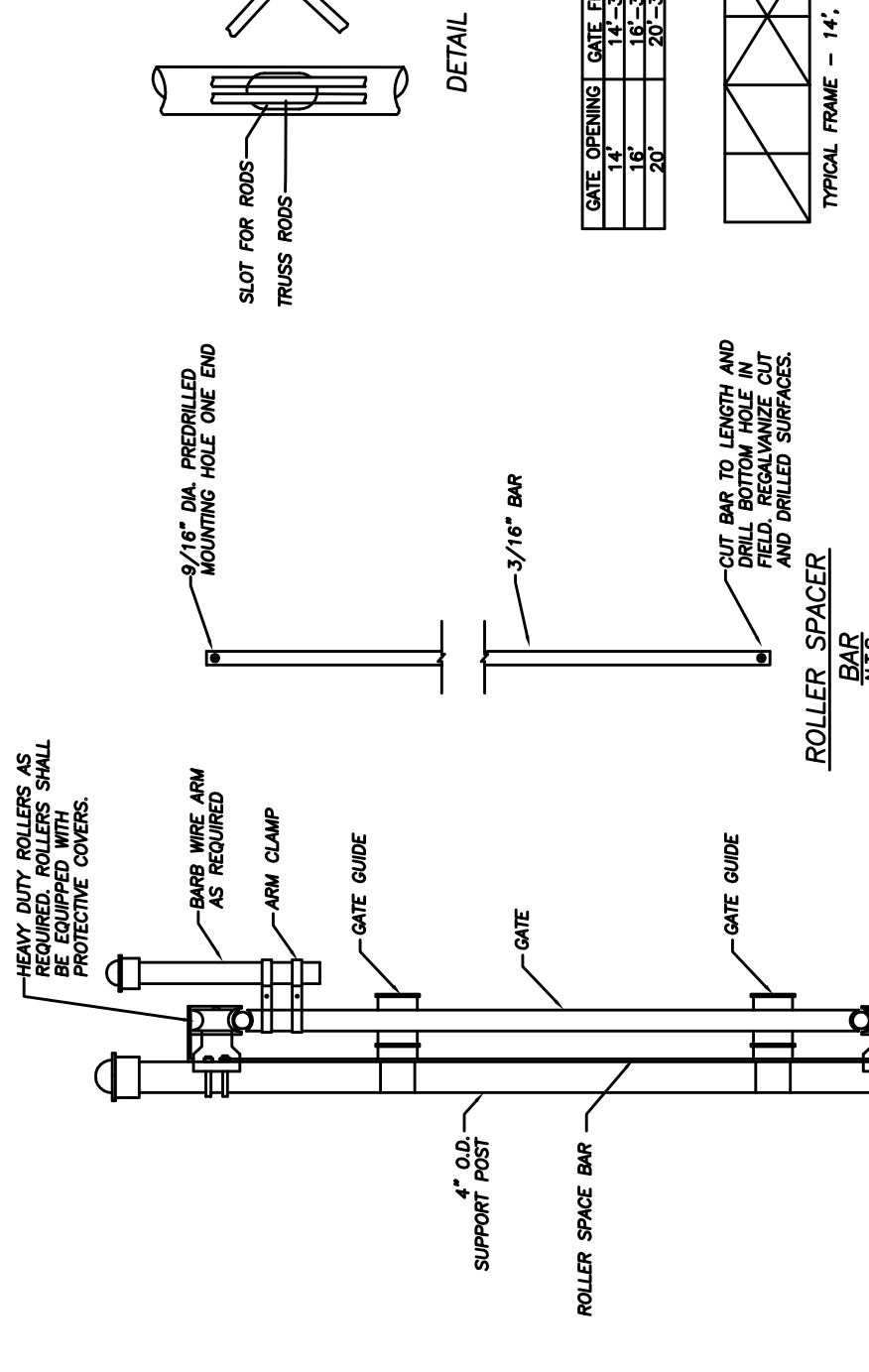
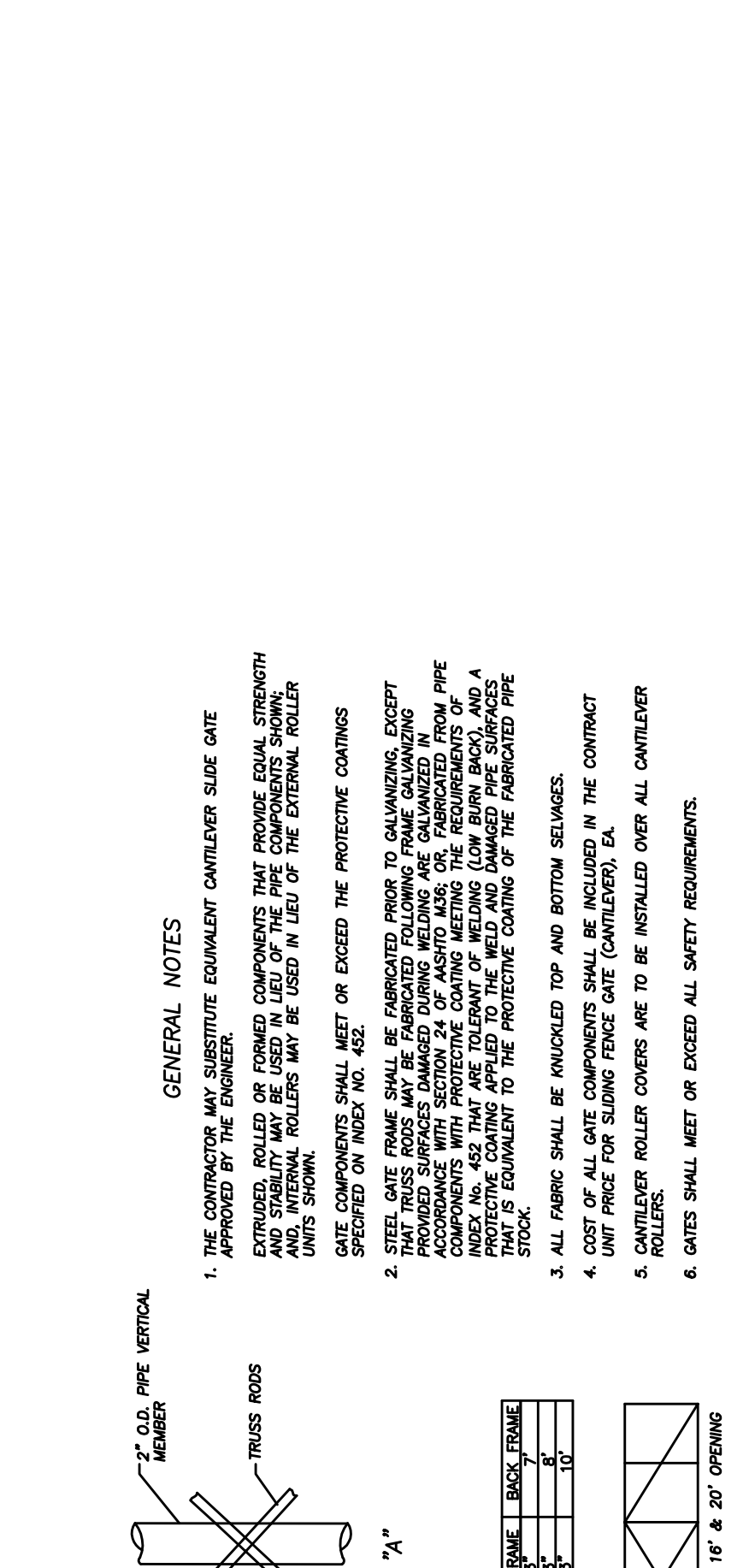
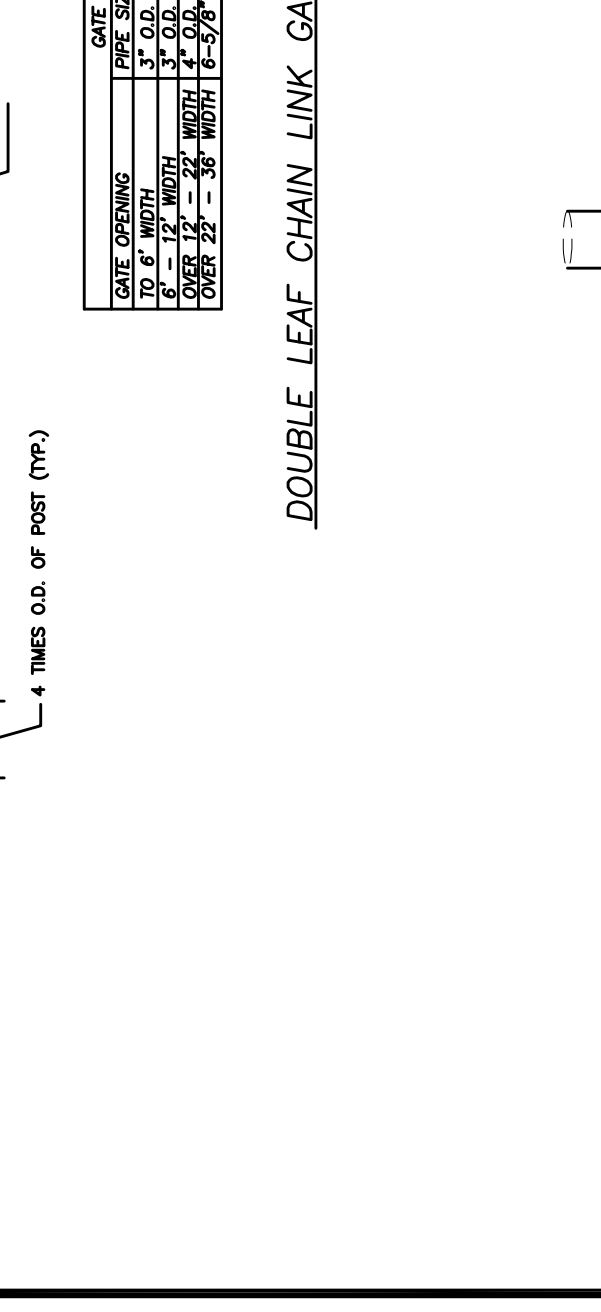
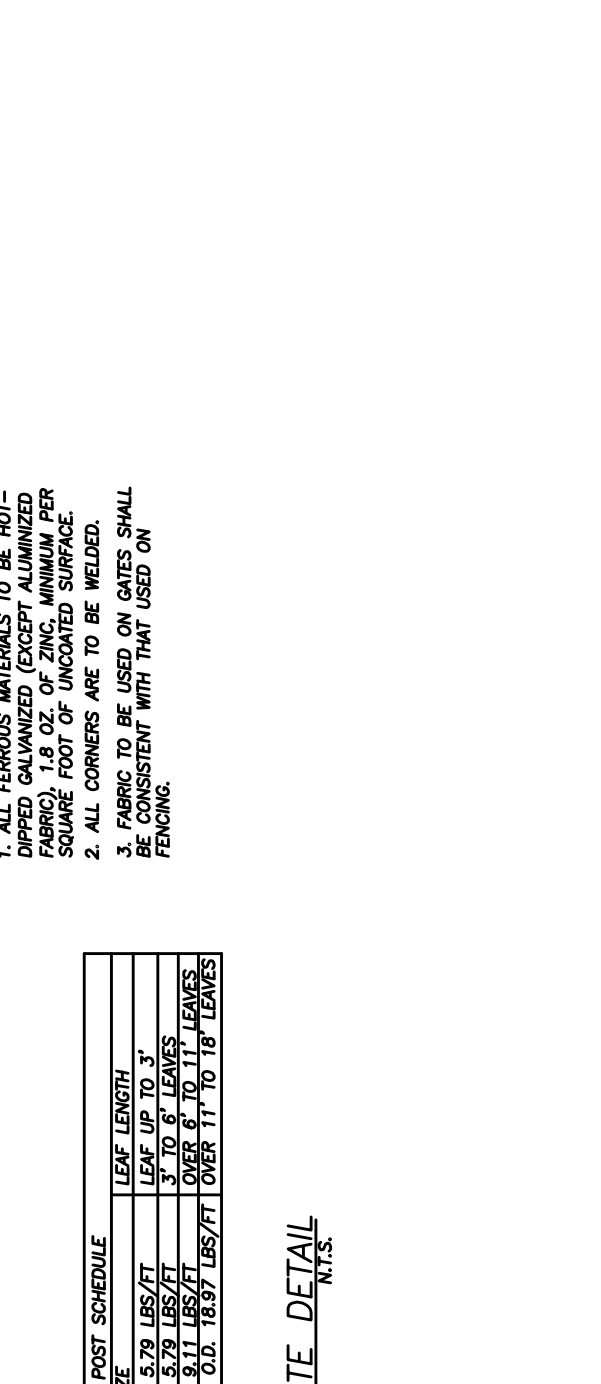
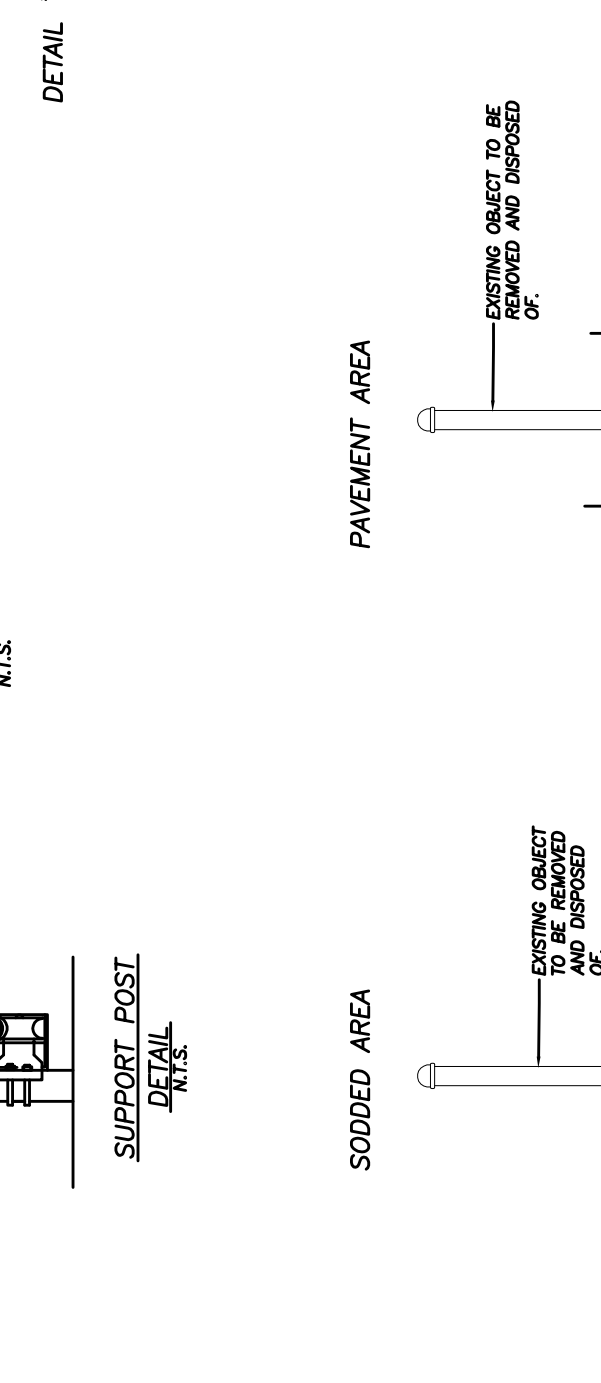
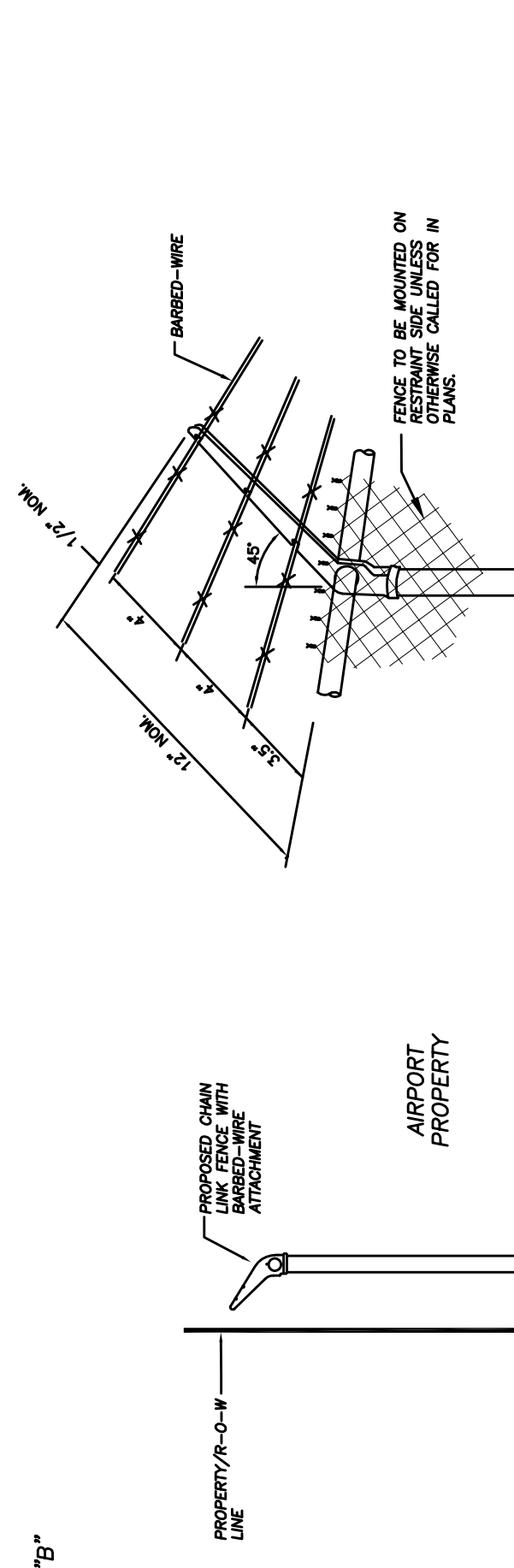
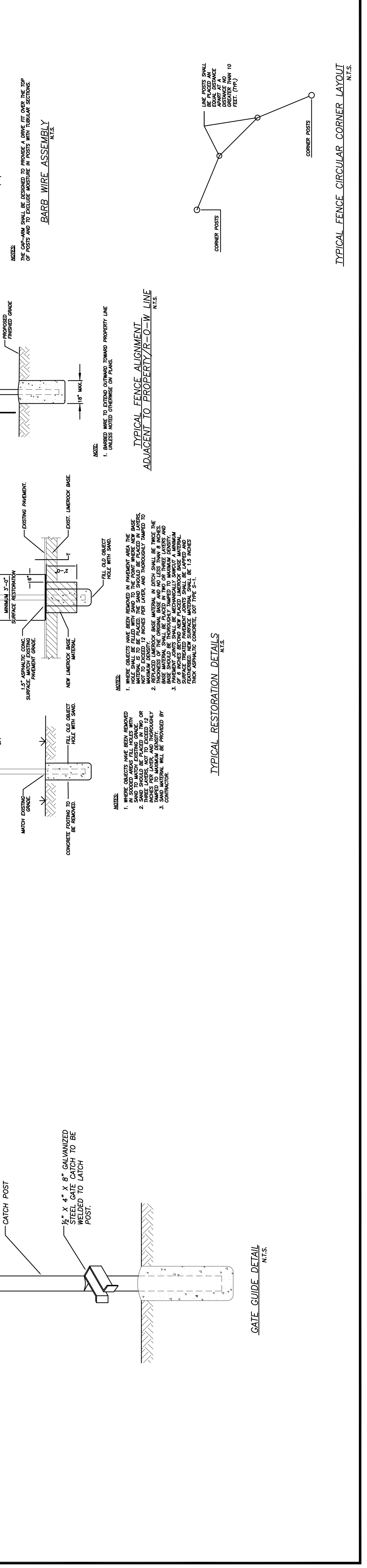

CITY OF FORT LAUDERDALE
PUBLIC WORKS DEPARTMENT
ENGINEERING DIVISION
FORT LAUDERDALE, FLORIDA

REVISIONS

NO.	DATE	BY	CHK'D	DESCRIPTION

PROJECT # (SERV. CONT.)
ANNUAL CHAIN-LINK &
REPAIR SERVICE CONTRACT
FENCE & GATE DETAILS

NO. OF SHEETS: 03
SHEET NO.: 02
CAD FILE NO. 04-129-40

SCALE: N.T.S.
DRAWN BY: A.C.
DESIGNED BY: S.N.
CHECKED BY: FIELD BOOK: 0
DATE: 12/27/05
FLA. REG. ENG. NO. 48266
KARIM RAHMANKHANAH
FINAL APPROVAL

GENERAL FENCE NOTES:

- MANUFACTURER SHALL BE: FENCE MASTERS INC. OR APPROVED EQUAL, 5530 N.W. 34TH STREET MIAMI, FL 33142
- CONTACT INFORMATION: (305)-635-7777
- SEE SITE PLAN FOR ALL FENCE HEIGHTS AND LOCATIONS.
- (3) THREE FENCE PANELS SHALL BE INSTALLED BETWEEN COLUMNS AS LOCATED ON SITE PLAN UNLESS OTHERWISE STATED.
- CONTRACTOR SHALL STAKE ALL COLUMN AND FENCE LOCATIONS PRIOR TO INSTALLATION FOR FINAL APPROVAL BY THE CITY OF FORT LAUDERDALE.
- SEE STRUCTURAL SITE PLAN DETAILS FOR ADDITIONAL INFORMATION.
- ALL MATERIALS & ATTACHMENTS DEVICES SHALL BE VERIFIED BY MANUFACTURER.

STEEL PICKET FENCE
NOM 8' SECTION LENGTH - 1" PICKETS
SCALE: N.T.S.

NOTES:
1. METRIC DIMENSIONS ARE NOMINAL EQUIVALENTS TO U.S. DIMENSIONS.
2. ALL MATERIALS & ATTACHMENTS SHALL BE WELDED TO U.S. DIMENSIONS.
3. ALL PICKETS SHALL BE WELDED TO U.S. DIMENSIONS.

NOM. HEIGHT (H)	ACTUAL HEIGHT (H)
6'-0" [1829MM]	6'-0" [1829MM]
32'-0" [9754MM]	32'-0" [9754MM]

STEEL PICKET SLIDING GATE
W/ STRAIGHT TOP & 1" PICKETS
SCALE: N.T.S.

NOTES:
1. METRIC DIMENSIONS ARE NOMINAL EQUIVALENTS TO U.S. DIMENSIONS.
2. ALL MATERIALS & ATTACHMENTS SHALL BE WELDED TO U.S. DIMENSIONS.
3. ALL PICKETS SHALL BE WELDED TO U.S. DIMENSIONS.

NOM. HEIGHT (H)	ACTUAL HEIGHT (H)
6'-0" [1829MM]	6'-0" [1829MM]
8'-8" 3/8" [2600MM]	8'-0" [2438MM]

STEEL PICKET DOUBLE SWING GATE
W/ STRAIGHT TOP & 1" PICKETS
SCALE: N.T.S.

NOTES:
1. METRIC DIMENSIONS ARE NOMINAL EQUIVALENTS TO U.S. DIMENSIONS.
2. GATES SHALL BE MANUALLY OPERATED.
3. GATES SHALL HAVE 3 RAILS TO MATCH FENCE.
4. SEE SITE PLAN FOR FENCE LOCATION & HEIGHTS.

NOM. HEIGHT (H)	ACTUAL HEIGHT (H)
6'-0" [1829MM]	6'-0" [1829MM]
8'-8" 3/8" [2600MM]	8'-0" [2438MM]

STEEL PICKET SINGLE SWING GATE
W/ STRAIGHT TOP & 1" PICKETS
SCALE: N.T.S.

NOTES:
1. METRIC DIMENSIONS ARE NOMINAL EQUIVALENTS TO U.S. DIMENSIONS.
2. GATES SHALL BE MANUALLY OPERATED.
3. GATES SHALL HAVE 3 RAILS TO MATCH FENCE.
4. SEE SITE PLAN FOR FENCE LOCATION & HEIGHTS.

NOM. HEIGHT (H)	ACTUAL HEIGHT (H)
6'-0" [1829MM]	6'-0" [1829MM]
8'-4" 7/8" [1922MM]	6'-0" [1829MM]

STEEL PICKET SINGLE CANTILEVERED SLIDING GATE
W/ 1" PICKETS
SCALE: N.T.S.

NOTES:
1. METRIC DIMENSIONS ARE NOMINAL EQUIVALENTS TO U.S. DIMENSIONS.
2. ALL MATERIALS & ATTACHMENTS SHALL BE INSTALLED PER MANUFACTURER'S SPECIFICATIONS.

STEEL PICKET PANEL LAYOUT
3 PANELS (TYP.)
SCALE: N.T.S.

NOTE:
(3) THREE FENCE PANELS SHALL BE INSTALLED BETWEEN COLUMNS AS LOCATED ON SITE PLAN UNLESS OTHERWISE STATED.

GATE ELEVATION - (5) BAYS SHOWN

NOTES:
1. METRIC DIMENSIONS ARE NOMINAL EQUIVALENTS TO U.S. DIMENSIONS.
2. ALL MATERIALS & ATTACHMENTS SHALL BE WELDED TO U.S. DIMENSIONS.
3. ALL PICKETS SHALL BE WELDED TO U.S. DIMENSIONS.

STEEL PICKET FENCE BASIC ASSEMBLY
SCALE: N.T.S.

NOTES:
1. METRIC DIMENSIONS ARE NOMINAL EQUIVALENTS TO U.S. DIMENSIONS.
2. FACE TO FACE DIM FOR 8' [2438MM] SECTION: 7'-8" 3/4" [2356MM].

STEEL PICKET FENCE CONNECTION DETAIL
SCALE: N.T.S.

STEEL PICKET FENCE CONNECTION DETAIL
SCALE: N.T.S.

STEEL PICKET FENCE CONNECTION DETAIL
SCALE: N.T.S.

STEEL PICKET FENCE CONNECTION DETAIL
SCALE: N.T.S.

STEEL PICKET FENCE CONNECTION DETAIL
SCALE: N.T.S.

STEEL PICKET FENCE CONNECTION DETAIL
SCALE: N.T.S.

NO. OF SHEETS: 03
SHEET NO.: 03
CAD FILE NO. DETL1
FILE NO. 04-129-40

PROJECT # (SERV. CONT.)
 ANNUAL CHAIN-LINK &
 PICKET FENCE INSTALL &
 REPAIR SERVICE CONTRACT
 FENCE & GATE DETAILS

NO.	DATE	BY	CHK'D	DESCRIPTION

CITY OF FORT LAUDERDALE
 PUBLIC WORKS DEPARTMENT
 ENGINEERING DIVISION
 FORT LAUDERDALE, FLORIDA

SCALE: N.T.S.
DESIGNED BY: DATE: 12/27/05
FLA. REG. ENG. NO. 48266
KARIM RAHMANKHAH
FINAL APPROVAL

- NOTES**
- STANDARD FITTINGS ARE FOR 4" O.D. POSTS.
 - MOUNT HANGERS 4" BELOW FENCELINE. INSTALL TRUCKS IN HANGERS AND TIGHTEN LOCKNUTS. TRUCKS MUST BE LEVEL WITH EACH OTHER.
 - MOVE GATE TO FULLY CLOSED POSITION. PROP UP LATCH END TO MAKE GATE LEVEL. THEN TIGHTEN ALL CABLES STARTING AT THE HANGER POST END, UNTIL GATE LIFTS SLIGHTLY.
 - PLACE GATE IN FULLY OPENED POSITION AND PROP UP COUNTERBALANCE END UNTIL GATE IS LEVEL. TIGHTEN THE OPPOSING CABLES UNTIL THE GATE LIFTS SLIGHTLY.

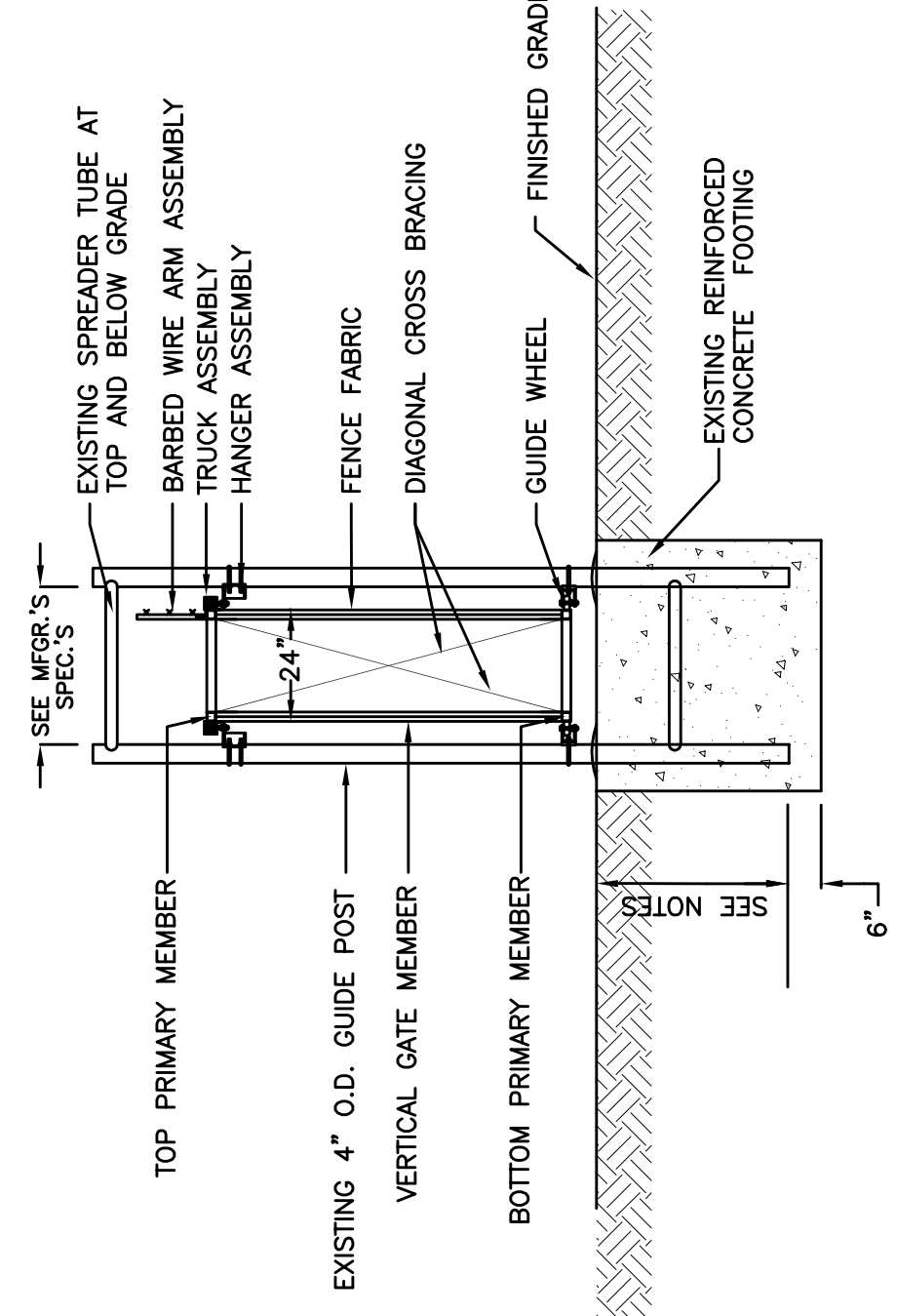
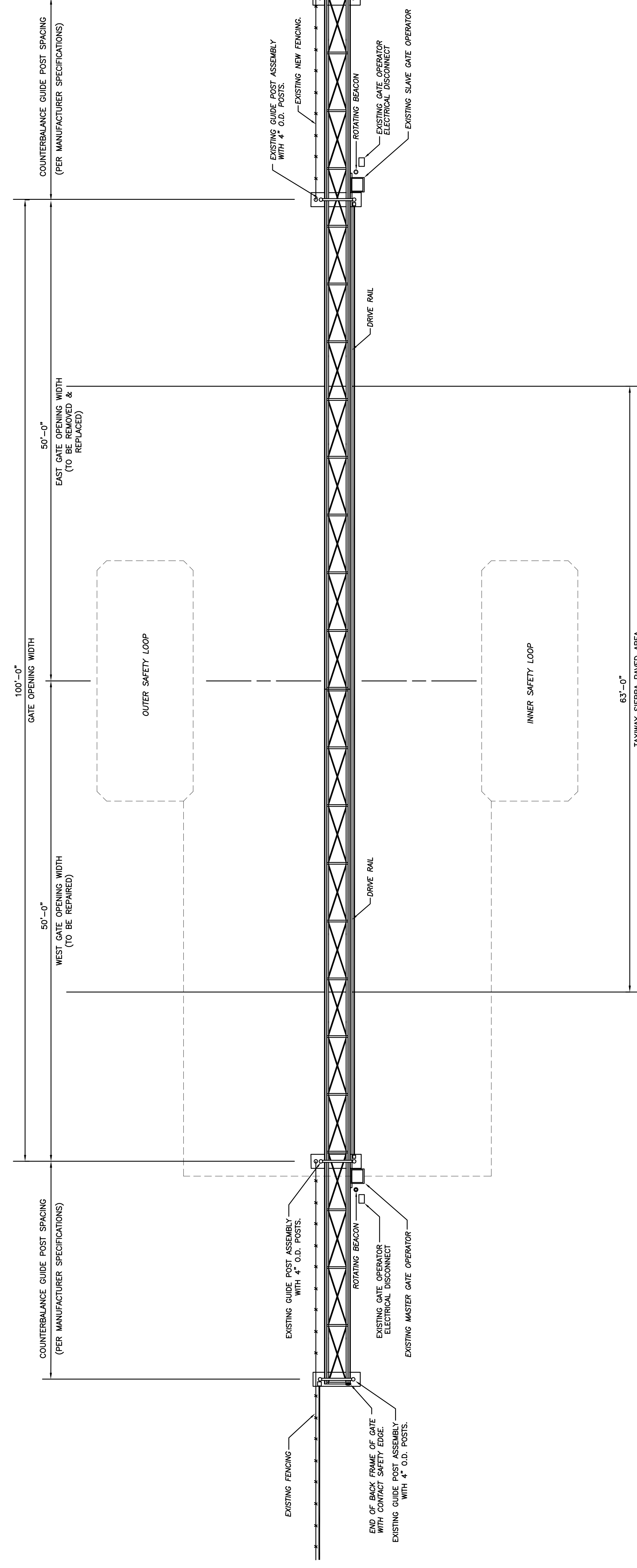
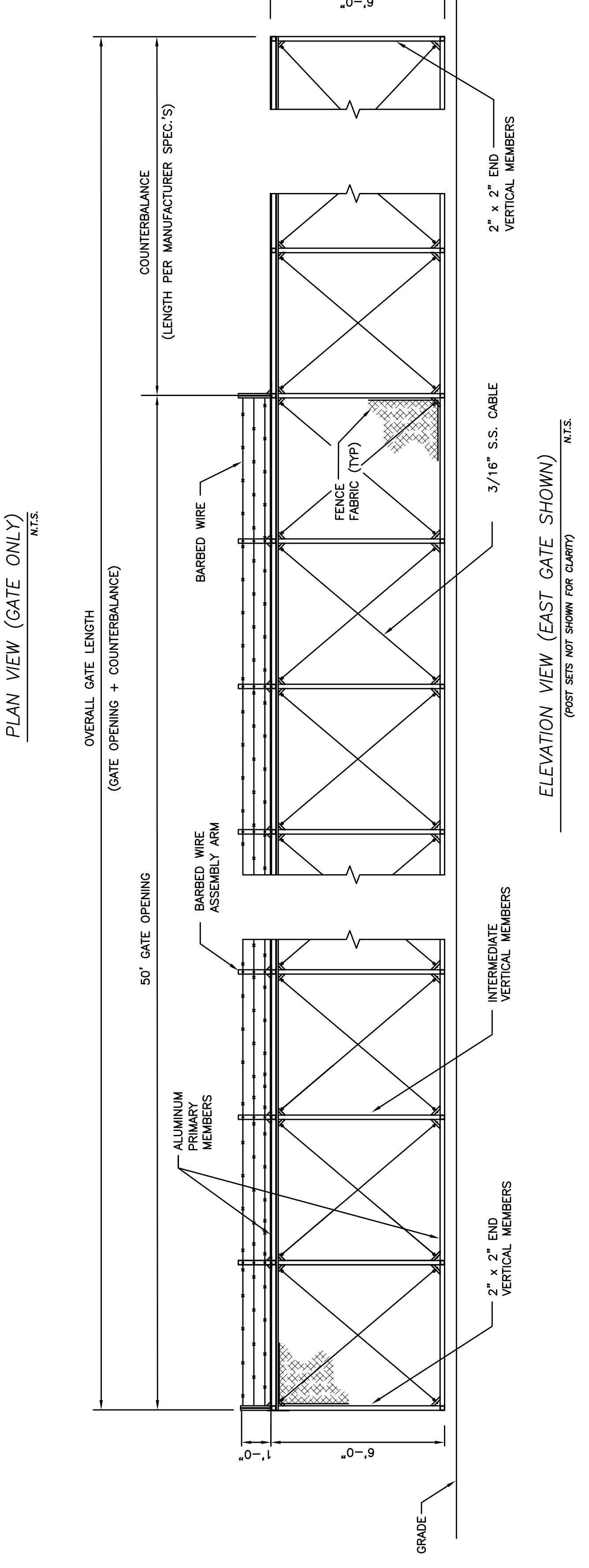
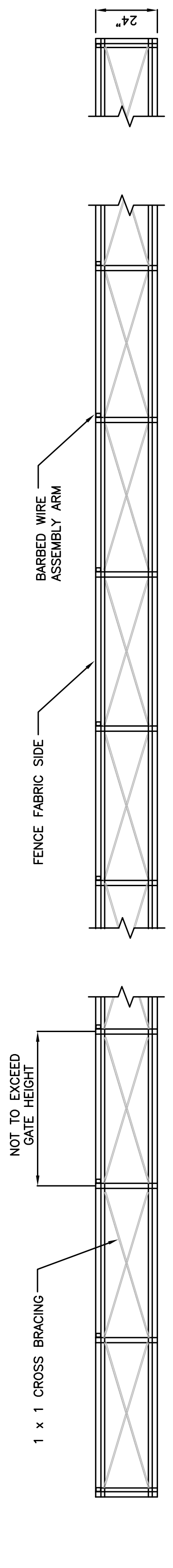

NOTES:
 PRIOR TO COMMENCEMENT OF CONSTRUCTION, THE CONTRACTOR SHALL PROVIDE A SHOP DRAWING SUBMITTAL SIGNED & SEALED BY A REGISTERED PROFESSIONAL ENGINEER LICENSED IN THE STATE OF FLORIDA, CONSISTING OF THE GATE SYSTEM DESIGN AND INSTALLATION.

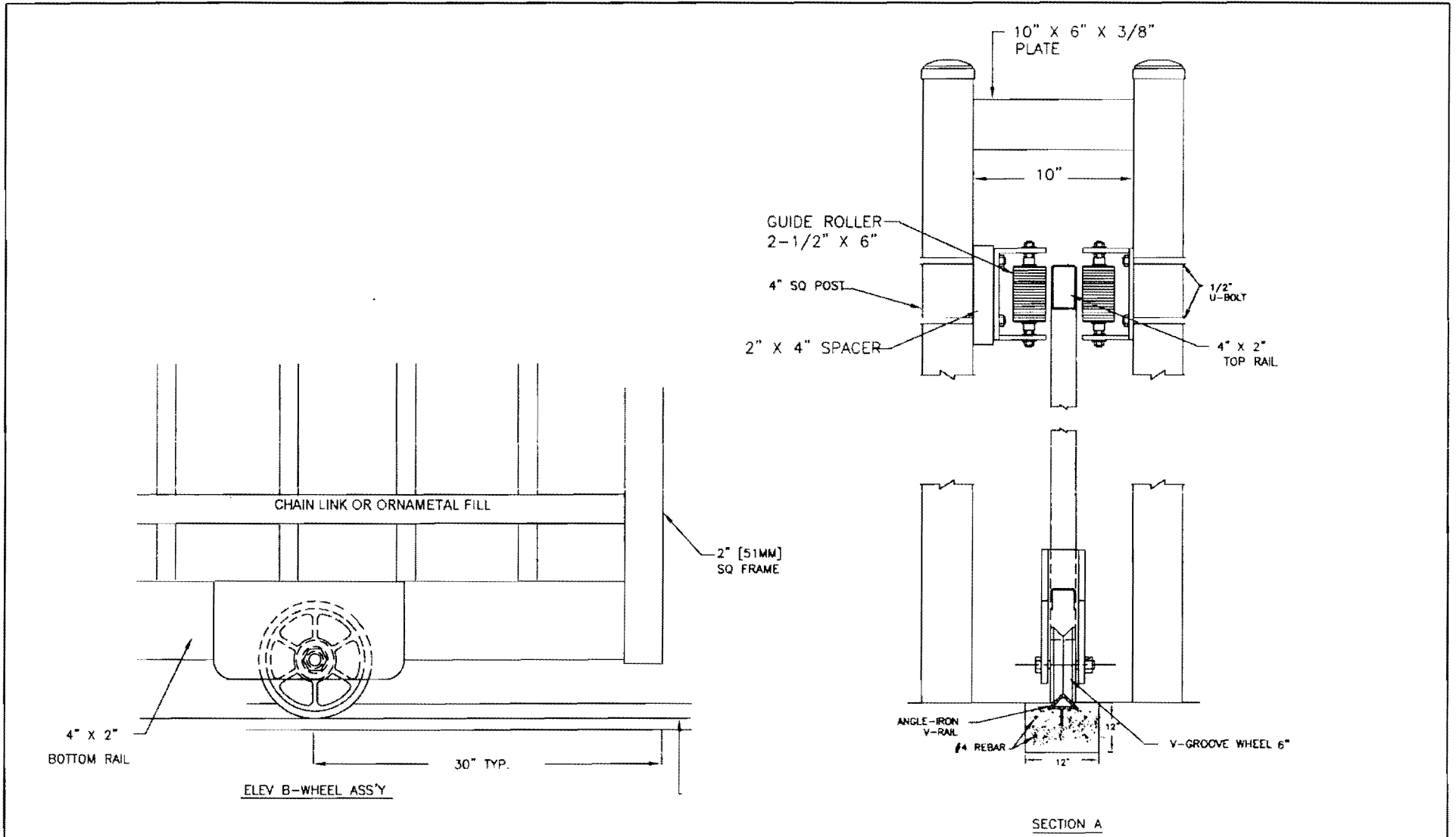

ROLLING GATE

INDUSTRIAL

BY:

DATE:

REV:

SCALE:

**CITY OF FORT LAUDERDALE
GENERAL CONDITIONS**

These instructions and conditions are standard for all contracts for commodities or services issued through the City of Fort Lauderdale Procurement Services Division. The City may delete, supersede, or modify any of these standard instructions for a particular contract by indicating such change in the Invitation to Bid (ITB) Special Conditions, Technical Specifications, Instructions, Proposal Pages, Addenda, and Legal Advertisement. In this general conditions document, Invitation to Bid (ITB), Request for Qualifications (RFQ), and Request for Proposal (RFP) are interchangeable.

PART I BIDDER PROPOSAL PAGE(S) CONDITIONS:

- 1.01 BIDDER ADDRESS:** The City maintains automated vendor address lists that have been generated for each specific Commodity Class item through our bid issuing service, BidSync. Notices of Invitations to Bid (ITB'S) are sent by e-mail to the selection of bidders who have fully registered with BidSync or faxed (if applicable) to every vendor on those lists, who may then view the bid documents online. Bidders who have been informed of a bid's availability in any other manner are responsible for registering with BidSync in order to view the bid documents. There is no fee for doing so. If you wish bid notifications be provided to another e-mail address or fax, please contact BidSync. If you wish purchase orders sent to a different address, please so indicate in your bid response. If you wish payments sent to a different address, please so indicate on your invoice.
- 1.02 DELIVERY:** Time will be of the essence for any orders placed as a result of this ITB. The City reserves the right to cancel any orders, or part thereof, without obligation if delivery is not made in accordance with the schedule specified by the Bidder and accepted by the City.
- 1.03 PACKING SLIPS:** It will be the responsibility of the awarded Contractor, to attach all packing slips to the OUTSIDE of each shipment. Packing slips must provide a detailed description of what is to be received and reference the City of Fort Lauderdale purchase order number that is associated with the shipment. Failure to provide a detailed packing slip attached to the outside of shipment may result in refusal of shipment at Contractor's expense.
- 1.04 PAYMENT TERMS AND CASH DISCOUNTS:** Payment terms, unless otherwise stated in this ITB, will be considered to be net 45 days after the date of satisfactory delivery at the place of acceptance and receipt of correct invoice at the office specified, whichever occurs last. Bidder may offer cash discounts for prompt payment but they will not be considered in determination of award. If a Bidder offers a discount, it is understood that the discount time will be computed from the date of satisfactory delivery, at the place of acceptance, and receipt of correct invoice, at the office specified, whichever occurs last.
- 1.05 TOTAL BID DISCOUNT:** If Bidder offers a discount for award of all items listed in the bid, such discount shall be deducted from the total of the firm net unit prices bid and shall be considered in tabulation and award of bid.
- 1.06 BIDS FIRM FOR ACCEPTANCE:** Bidder warrants, by virtue of bidding, that the bid and the prices quoted in the bid will be firm for acceptance by the City for a period of one hundred twenty (120) days from the date of bid opening unless otherwise stated in the ITB.
- 1.07 VARIANCES:** For purposes of bid evaluation, Bidder's must indicate any variances, no matter how slight, from ITB General Conditions, Special Conditions, Specifications or Addenda in the space provided in the ITB. No variations or exceptions by a Bidder will be considered or deemed a part of the bid submitted unless such variances or exceptions are listed in the bid and referenced in the space provided on the bidder proposal pages. If variances are not stated, or referenced as required, it will be assumed that the product or service fully complies with the City's terms, conditions, and specifications.

By receiving a bid, City does not necessarily accept any variances contained in the bid. All variances submitted are subject to review and approval by the City. If any bid contains material variances that, in the City's sole opinion, make that bid conditional in nature, the City reserves the right to reject the bid or part of the bid that is declared by the City as conditional.

- 1.08 NO BIDS:** If you do not intend to bid please indicate the reason, such as insufficient time to respond, do not offer product or service, unable to meet specifications, schedule would not permit, or any other reason, in the space provided in this ITB. Failure to bid or return no bid comments prior to the bid due and opening date and time, indicated in this ITB, may result in your firm being deleted from our Bidder's registration list for the Commodity Class Item requested in this ITB.
- 1.09 MINORITY AND WOMEN BUSINESS ENTERPRISE PARTICIPATION AND BUSINESS DEFINITIONS:** The City of Fort Lauderdale wants to increase the participation of Minority Business Enterprises (MBE), Women Business Enterprises (WBE), and Small Business Enterprises (SBE) in its procurement activities. If your firm qualifies in accordance with the below definitions please indicate in the space provided in this ITB.

Minority Business Enterprise (MBE) "A Minority Business" is a business enterprise that is owned or controlled by one or more socially or economically disadvantaged persons. Such disadvantage may arise from cultural, racial, chronic economic circumstances or background or other similar cause. Such persons include, but are not limited to: Blacks, Hispanics, Asian Americans, and Native Americans.

The term "Minority Business Enterprise" means a business at least 51 percent of which is owned by minority group members or, in the case of a publicly owned business, at least 51 percent of the stock of which is owned by minority group members. For the purpose of the preceding sentence, minority group members are citizens of the United States who include, but are not limited to: Blacks, Hispanics, Asian Americans, and Native Americans.

Women Business Enterprise (WBE) a "Women Owned or Controlled Business" is a business enterprise at least 51 percent of which is owned by females or, in the case of a publicly owned business, at least 51 percent of the stock of which is owned by females.

Small Business Enterprise (SBE) "Small Business" means a corporation, partnership, sole proprietorship, or other legal entity formed for the purpose of making a profit, which is independently owned and operated, has either fewer than 100 employees or less than \$1,000,000 in annual gross receipts.

BLACK, which includes persons having origins in any of the Black racial groups of Africa.

WHITE, which includes persons whose origins are Anglo-Saxon and Europeans and persons of Indo-European decent including Pakistani and East Indian.
 HISPANIC, which includes persons of Mexican, Puerto Rican, Cuban, Central and South American, or other Spanish culture or origin, regardless of race.
 NATIVE AMERICAN, which includes persons whose origins are American Indians, Eskimos, Aleuts, or Native Hawaiians.
 ASIAN AMERICAN, which includes persons having origin in any of the original peoples of the Far East, Southeast Asia, the Indian subcontinent, or the Pacific Islands.

1.10 MINORITY-WOMEN BUSINESS ENTERPRISE PARTICIPATION

It is the desire of the City of Fort Lauderdale to increase the participation of minority (MBE) and women-owned (WBE) businesses in its contracting and procurement programs. While the City does not have any preference or set aside programs in place, it is committed to a policy of equitable participation for these firms. Proposers are requested to include in their proposals a narrative describing their past accomplishments and intended actions in this area. If proposers are considering minority or women owned enterprise participation in their proposal, those firms, and their specific duties have to be identified in the proposal. If a proposer is considered for award, he or she will be asked to meet with City staff so that the intended MBE/WBE participation can be formalized and included in the subsequent contract.

1.11 SCRUTINIZED COMPANIES

As to any contract for goods or services of \$1 million or more and as to the renewal of any contract for goods or services of \$1 million or more, subject to *Odebrecht Construction, Inc., v. Prasad*, 876 F.Supp.2d 1305 (S.D. Fla. 2012), affirmed, *Odebrecht Construction, Inc., v. Secretary, Florida Department of Transportation*, 715 F.3d 1268 (11th Cir. 2013), with regard to the "Cuba Amendment," the Contractor certifies that it is not on the Scrutinized Companies with Activities in Sudan List or the Scrutinized Companies with Activities in the Iran Petroleum Energy Sector List, and that it does not have business operations in Cuba or Syria, as provided in section 287.135, Florida Statutes (2019), as may be amended or revised. As to any contract for goods or services of any amount and as to the renewal of any contract for goods or services of any amount, the Contractor certifies that it is not on the Scrutinized Companies that Boycott Israel List created pursuant to Section 215.4725, Florida Statutes (2019), and that it is not engaged in a boycott of Israel. The City may terminate this Agreement at the City's option if the Contractor is found to have submitted a false certification as provided under subsection (5) of section 287.135, Florida Statutes (2019), as may be amended or revised, or been placed on the Scrutinized Companies with Activities in Sudan List or the Scrutinized Companies with Activities in the Iran Petroleum Energy Sector List or the Scrutinized Companies that Boycott Israel List created pursuant to Section 215.4725, Florida Statutes (2019), or is engaged in a boycott of Israel, or has been engaged in business operations in Cuba or Syria, as defined in Section 287.135, Florida Statutes (2019), as may be amended or revised.

Rev. 2/2020

Page 1

1.12 DEBARRED OR SUSPENDED BIDDERS OR PROPOSERS

The bidder or proposer certifies, by submission of a response to this solicitation, that neither it nor its principals and subcontractors are presently debarred or suspended by any Federal department or agency.

Part II DEFINITIONS/ORDER OF PRECEDENCE:

2.01 BIDDING DEFINITIONS The City will use the following definitions in its general conditions, special conditions, technical specifications, instructions to bidders, addenda and any other document used in the bidding process:

INVITATION TO BID (ITB) The solicitation document used for soliciting competitive sealed bids for goods or services.

INVITATION TO NEGOTIATE (ITN) All solicitation documents, regardless of medium, whether attached to or incorporated by reference in solicitations for responses from firms that invite proposals from interested and qualified firms so the city may enter into negotiations with the firm(s) determined most capable of providing the required goods or services.

REQUEST FOR PROPOSALS (RFP) A solicitation method used for soliciting competitive sealed proposals to determine the best value among proposals for goods or services for which price may not be the prevailing factor in award of the contract, or the scope of work, specifications or contract terms and conditions may be difficult to define. Such solicitation will consider the qualifications of the proposers along with evaluation of each proposal using identified and generally weighted evaluation criteria. RFPs may include price criteria whenever feasible, at the discretion of the city.

REQUEST FOR QUALIFICATIONS (RFQ) A solicitation method used for requesting statements of qualifications in order to determine the most qualified proposer for professional services.

BID – a price and terms quote received in response to an ITB.

PROPOSAL – a proposal received in response to an RFP.

BIDDER – Person or firm submitting a Bid.

PROPOSER – Person or firm submitting a Proposal.

RESPONSIVE BIDDER – A firm who has submitted a bid, offer, quote, or response which conforms in all material respects to the competitive solicitation document and all of its requirements.

RESPONSIBLE BIDDER – A firm who is fully capable of meeting all requirements of the solicitation and subsequent contract. The respondent must possess the full capability, including financial and technical, ability, business judgment, experience, qualifications, facilities, equipment, integrity, capability, and reliability, in all respects to perform fully the contract requirements and assure good faith performance as determined by the city.

FIRST RANKED PROPOSER – That Proposer, responding to a City RFP, whose Proposal is deemed by the City, the most advantageous to the City after applying the evaluation criteria contained in the RFP.

SELLER – Successful Bidder or Proposer who is awarded a Purchase Order or Contract to provide goods or services to the City.

CONTRACTOR – Any firm having a contract with the city. Also referred to as a "Vendor".

CONTRACT – All types of agreements, including purchase orders, for procurement of supplies, services, and construction, regardless of what these agreements may be called.

CONSULTANT – A firm providing professional services for the city.

- 2.02 SPECIAL CONDITIONS:** Any and all Special Conditions contained in this ITB that may be in variance or conflict with these General Conditions shall have precedence over these General Conditions. If no changes or deletions to General Conditions are made in the Special Conditions, then the General Conditions shall prevail in their entirety,

PART III BIDDING AND AWARD PROCEDURES:

- 3.01 SUBMISSION AND RECEIPT OF BIDS:** To receive consideration, bids must be received prior to the bid opening date and time. Unless otherwise specified, Bidders should use the proposal forms provided by the City. These forms may be duplicated, but failure to use the forms may cause the bid to be rejected. Any erasures or corrections on the bid must be made in ink and initialed by Bidder in ink. All information submitted by the Bidder shall be printed, typewritten or filled in with pen and ink. Bids shall be signed in ink. Separate bids must be submitted for each ITB issued by the City in separate sealed envelopes properly marked. When a particular ITB or RFP requires multiple copies of bids or proposals they may be included in a single envelope or package properly sealed and identified. Only send bids via facsimile transmission (FAX) if the ITB specifically states that bids sent via FAX will be considered. If such a statement is not included in the ITB, bids sent via FAX will be rejected. Bids will be publicly opened in the Procurement Office, or other designated area, in the presence of Bidders, the public, and City staff. Bidders and the public are invited and encouraged to attend bid openings. Bids will be tabulated and made available for review by Bidder's and the public in accordance with applicable regulations.
- 3.02 MODEL NUMBER CORRECTIONS:** If the model number for the make specified in this ITB is incorrect, or no longer available and replaced with an updated model with new specifications, the Bidder shall enter the correct model number on the bidder proposal page. In the case of an updated model with new specifications, Bidder shall provide adequate information to allow the City to determine if the model bid meets the City's requirements.
- 3.03 PRICES QUOTED:** Deduct trade discounts, and quote firm net prices. Give both unit price and extended total. In the case of a discrepancy in computing the amount of the bid, the unit price quoted will govern. All prices quoted shall be F.O.B. destination, freight prepaid (Bidder pays and bears freight charges, Bidder owns goods in transit and files any claims), unless otherwise stated in Special Conditions. Each item must be bid separately. No attempt shall be made to tie any item or items contained in the ITB with any other business with the City.
- 3.04 TAXES:** The City of Fort Lauderdale is exempt from Federal Excise and Florida Sales taxes on direct purchase of tangible property. Exemption **number for EIN is 59-6000319, and State Sales tax exemption number is 85-8013875578C-1.**
- 3.05 WARRANTIES OF USAGE:** Any quantities listed in this ITB as estimated or projected are provided for tabulation and information purposes only. No warranty or guarantee of quantities is given or implied. It is understood that the Contractor will furnish the City's needs as they arise.
- 3.06 APPROVED EQUAL:** When the technical specifications call for a brand name, manufacturer, make, model, or vendor catalog number with acceptance of APPROVED EQUAL, it shall be for the purpose of establishing a level of quality and features desired and acceptable to the City. In such cases, the City will be receptive to any unit that would be considered by qualified City personnel as an approved equal. In that the specified make and model represent a level of quality and features desired by the City, the Bidder must state clearly in the bid any variance from those specifications. It is the Bidder's responsibility to provide adequate information, in the bid, to enable the City to ensure that the bid meets the required criteria. If adequate information is not submitted with the bid, it may be rejected. The City will be the sole judge in determining if the item bid qualifies as an approved equal.
- 3.07 MINIMUM AND MANDATORY TECHNICAL SPECIFICATIONS:** The technical specifications may include items that are considered minimum, mandatory, or required. If any Bidder is unable to meet or exceed these items, and feels that the technical specifications are overly restrictive, the bidder must notify the Procurement Services Division immediately. Such notification must be received by the Procurement Services Division prior to the deadline contained in the ITB, for questions of a material nature, or prior to five (5) days before bid due and open date, whichever occurs first. If no such notification is received prior to that deadline, the City will consider the technical specifications to be acceptable to all bidders.
- 3.08 MISTAKES:** Bidders are cautioned to examine all terms, conditions, specifications, drawings, exhibits, addenda, delivery instructions and special conditions pertaining to the ITB. Failure of the Bidder to examine all pertinent documents shall not entitle the bidder to any relief from the conditions imposed in the contract.
- 3.09 SAMPLES AND DEMONSTRATIONS:** Samples or inspection of product may be requested to determine suitability. Unless otherwise specified in Special Conditions, samples shall be requested after the date of bid opening, and if requested should be received by the City within seven (7) working days of request. Samples, when requested, must be furnished free of expense to the City and if not used in testing or destroyed, will upon request of the Bidder, be returned within thirty (30) days of bid award at Bidder's expense. When required, the City may request full demonstrations of units prior to award. When such demonstrations are requested, the Bidder shall respond promptly and arrange a demonstration at a convenient location. Failure to provide samples or demonstrations as specified by the City may result in rejection of a bid.
- 3.10 LIFE CYCLE COSTING:** If so specified in the ITB, the City may elect to evaluate equipment proposed on the basis of total cost of ownership. In using Life Cycle Costing, factors such as the following may be considered: estimated useful life, maintenance costs, cost of supplies, labor intensity, energy usage, environmental impact, and residual value. The City reserves the right to use those or other applicable criteria, in its sole opinion that will most accurately estimate total cost of use and ownership.
- 3.11 BIDDING ITEMS WITH RECYCLED CONTENT:** In addressing environmental concerns, the City of Fort Lauderdale encourages Bidders to submit bids or alternate bids containing items with recycled content. When submitting bids containing items with recycled content, Bidder shall provide documentation adequate for the City to verify the recycled content. The City prefers packaging consisting of materials that are degradable or able to be recycled. When specifically stated in the ITB, the City may give preference to bids containing items manufactured with recycled material or packaging that is able to be recycled.

- 3.12 USE OF OTHER GOVERNMENTAL CONTRACTS:** The City reserves the right to reject any part or all of any bids received and utilize other available governmental contracts, if such action is in its best interest.
- 3.13 QUALIFICATIONS/INSPECTION:** Bids will only be considered from firms normally engaged in providing the types of commodities/services specified herein. The City reserves the right to inspect the Bidder's facilities, equipment, personnel, and organization at any time, or to take any other action necessary to determine Bidder's ability to perform. The Procurement Director reserves the right to reject bids where evidence or evaluation is determined to indicate inability to perform.
- 3.14 BID SURETY:** If Special Conditions require a bid security, it shall be submitted in the amount stated. A bid security can be in the form of a bid bond or cashier's check. Bid security will be returned to the unsuccessful bidders as soon as practicable after opening of bids. Bid security will be returned to the successful bidder after acceptance of the performance bond, if required; acceptance of insurance coverage, if required; and full execution of contract documents, if required; or conditions as stated in Special Conditions.
- 3.15 PUBLIC RECORDS/TRADE SECRETS/COPYRIGHT:** The Proposer's response to the RFP is a public record pursuant to Florida law, which is subject to disclosure by the City under the State of Florida Public Records Law, Florida Statutes Chapter 119.07 ("Public Records Law"). The City shall permit public access to all documents, papers, letters or other material submitted in connection with this RFP and the Contract to be executed for this RFP, subject to the provisions of Chapter 119.07 of the Florida Statutes.

Any language contained in the Proposer's response to the RFP purporting to require confidentiality of any portion of the Proposer's response to the RFP, except to the extent that certain information is in the City's opinion a Trade Secret pursuant to Florida law, shall be void. If a Proposer submits any documents or other information to the City which the Proposer claims is Trade Secret information and exempt from Florida Statutes Chapter 119.07 ("Public Records Laws"), the Proposer shall clearly designate that it is a Trade Secret and that it is asserting that the document or information is exempt. The Proposer must specifically identify the exemption being claimed under Florida Statutes 119.07. The City shall be the final arbiter of whether any information contained in the Proposer's response to the RFP constitutes a Trade Secret. The city's determination of whether an exemption applies shall be final, and the proposer agrees to defend, indemnify, and hold harmless the City and the City's officers, employees, and agents, against any loss or damages incurred by any person or entity as a result of the City's treatment of records as public records. In addition, the proposer agrees to defend, indemnify, and hold harmless the City and the City's officers, employees, and agents, against any loss or damages incurred by any person or entity as a result of the City's treatment of records as exempt from disclosure or confidential. Proposals bearing copyright symbols or otherwise purporting to be subject to copyright protection in full or in part may be rejected. The proposer authorizes the City to publish, copy, and reproduce any and all documents submitted to the City bearing copyright symbols or otherwise purporting to be subject to copyright protection.

EXCEPT FOR CLEARLY MARKED PORTIONS THAT ARE BONA FIDE TRADE SECRETS PURSUANT TO FLORIDA LAW, DO NOT MARK YOUR RESPONSE TO THE RFP AS PROPRIETARY OR CONFIDENTIAL. DO NOT MARK YOUR RESPONSE TO THE RFP OR ANY PART THEREOF AS COPYRIGHTED.

- 3.16 PROHIBITION OF INTEREST:** No contract will be awarded to a bidding firm who has City elected officials, officers or employees affiliated with it, unless the bidding firm has fully complied with current Florida State Statutes and City Ordinances relating to this issue. Bidders must disclose any such affiliation. Failure to disclose any such affiliation will result in disqualification of the Bidder and removal of the Bidder from the City's bidder lists and prohibition from engaging in any business with the City.
- 3.17 RESERVATIONS FOR AWARD AND REJECTION OF BIDS:** The City reserves the right to accept or reject any or all bids, part of bids, and to waive minor irregularities or variations to specifications contained in bids, and minor irregularities in the bidding process. The City also reserves the right to award the contract on a split order basis, lump sum basis, individual item basis, or such combination as shall best serve the interest of the City. The City reserves the right to make an award to the responsive and responsible bidder whose product or service meets the terms, conditions, and specifications of the ITB and whose bid is considered to best serve the City's interest. In determining the responsiveness of the offer and the responsibility of the Bidder, the following shall be considered when applicable: the ability, capacity and skill of the Bidder to perform as required; whether the Bidder can perform promptly, or within the time specified, without delay or interference; the character, integrity, reputation, judgment, experience and efficiency of the Bidder; the quality of past performance by the Bidder; the previous and existing compliance by the Bidder with related laws and ordinances; the sufficiency of the Bidder's financial resources; the availability, quality and adaptability of the Bidder's supplies or services to the required use; the ability of the Bidder to provide future maintenance, service or parts; the number and scope of conditions attached to the bid.

If the ITB provides for a contract trial period, the City reserves the right, in the event the selected bidder does not perform satisfactorily, to award a trial period to the next ranked bidder or to award a contract to the next ranked bidder, if that bidder has successfully provided services to the City in the past. This procedure to continue until a bidder is selected or the contract is re-bid, at the sole option of the City.

- 3.18 LEGAL REQUIREMENTS:** Applicable provisions of all federal, state, county laws, and local ordinances, rules and regulations, shall govern development, submittal and evaluation of all bids received in response hereto and shall govern any and all claims and disputes which may arise between person(s) submitting a bid response hereto and the City by and through its officers, employees and authorized representatives, or any other person, natural or otherwise; and lack of knowledge by any bidder shall not constitute a cognizable defense against the legal effect thereof.
- 3.19 BID PROTEST PROCEDURE:** Any proposer or bidder who is not recommended for award of a contract and who alleges a failure by the city to follow the city's procurement ordinance or any applicable law may protest to the chief procurement officer, by delivering a letter of protest to the director of finance within five (5) days after a notice of intent to award is posted on the city's web site at the following url: <https://www.fortlauderdale.gov/departments/finance/procurement-services/notices-of-intent-to-award>

The complete protest ordinance may be found on the city's web site at the following url: https://library.municode.com/fl/fort_lauderdale/codes/code_of_ordinances?nodeid=coor_ch2ad_artvfi_div2pr_s2-182direpr

PART IV BONDS AND INSURANCE

- 4.01 PERFORMANCE BOND:** If a performance bond is required in Special Conditions, the Contractor shall within fifteen (15) working days after notification of award, furnish to the City a Performance Bond, payable to the City of Fort Lauderdale, Florida, in the face amount specified in Special Conditions as surety for faithful

performance under the terms and conditions of the contract. If the bond is on an annual coverage basis, renewal for each succeeding year shall be submitted to the City thirty (30) days prior to the termination date of the existing Performance Bond. The Performance Bond must be executed by a surety company of recognized standing, authorized to do business in the State of Florida and having a resident agent.

Acknowledgement and agreement is given by both parties that the amount herein set for the Performance Bond is not intended to be nor shall be deemed to be in the nature of liquidated damages nor is it intended to limit the liability of the Contractor to the City in the event of a material breach of this Agreement by the Contractor.

Rev. 2/2020

Page 3

4.02 INSURANCE: The Contractor shall assume full responsibility and expense to obtain all necessary insurance as required by City or specified in Special Conditions.

The Contractor shall provide to the Procurement Services Division original certificates of coverage and receive notification of approval of those certificates by the City's Risk Manager prior to engaging in any activities under this contract. The Contractor's insurance is subject to the approval of the City's Risk Manager. The certificates must list the City as an ADDITIONAL INSURED for General Liability Insurance and shall have no less than thirty (30) days written notice of cancellation or material change. Further modification of the insurance requirements may be made at the sole discretion of the City's Risk Manager if circumstances change or adequate protection of the City is not presented. Bidder, by submitting the bid, agrees to abide by such modifications.

PART V PURCHASE ORDER AND CONTRACT TERMS:

5.01 COMPLIANCE WITH SPECIFICATIONS, LATE DELIVERIES/PENALTIES: Items offered may be tested for compliance with bid specifications. Items delivered which do not conform to bid specifications may be rejected and returned at Contractor's expense. Any violation resulting in contract termination for cause or delivery of items not conforming to specifications, or late delivery may also result in:

- Bidder's name being removed from the City's bidder's mailing list for a specified period and Bidder will not be recommended for any award during that period.
- All City Departments being advised to refrain from doing business with the Bidder.
- All other remedies in law or equity.

5.02 ACCEPTANCE, CONDITION, AND PACKAGING: The material delivered in response to ITB award shall remain the property of the Seller until a physical inspection is made and the material accepted to the satisfaction of the City. The material must comply fully with the terms of the ITB, be of the required quality, new, and the latest model. All containers shall be suitable for storage and shipment by common carrier, and all prices shall include standard commercial packaging. The City will not accept substitutes of any kind. Any substitutes or material not meeting specifications will be returned at the Bidder's expense. Payment will be made only after City receipt and acceptance of materials or services.

5.03 SAFETY STANDARDS: All manufactured items and fabricated assemblies shall comply with applicable requirements of the Occupation Safety and Health Act of 1970 as amended.

5.04 ASBESTOS STATEMENT: All material supplied must be 100% asbestos free. Bidder, by virtue of bidding, certifies that if awarded any portion of the ITB the bidder will supply only material or equipment that is 100% asbestos free.

5.05 OTHER GOVERNMENTAL ENTITIES: If the Bidder is awarded a contract as a result of this ITB, the bidder may, if the bidder has sufficient capacity or quantities available, provide to other governmental agencies, so requesting, the products or services awarded in accordance with the terms and conditions of the ITB and resulting contract. Prices shall be F.O.B. delivered to the requesting agency.

5.06 VERBAL INSTRUCTIONS PROCEDURE: No negotiations, decisions, or actions shall be initiated or executed by the Contractor as a result of any discussions with any City employee. Only those communications which are in writing from an authorized City representative may be considered. Only written communications from Contractors, which are assigned by a person designated as authorized to bind the Contractor, will be recognized by the City as duly authorized expressions on behalf of Contractors.

5.07 INDEPENDENT CONTRACTOR: The Contractor is an independent contractor under this Agreement. Personal services provided by the Proposer shall be by employees of the Contractor and subject to supervision by the Contractor, and not as officers, employees, or agents of the City. Personnel policies, tax responsibilities, social security, health insurance, employee benefits, procurement policies unless otherwise stated in this ITB, and other similar administrative procedures applicable to services rendered under this contract shall be those of the Contractor.

5.08 INDEMNITY/HOLD HARMLESS AGREEMENT: Contractor shall protect and defend at Contractor's expense, counsel being subject to the City's approval, and indemnify and hold harmless the City and the City's officers, employees, volunteers, and agents from and against any and all losses, penalties, fines, damages, settlements, judgments, claims, costs, charges, expenses, or liabilities, including any award of attorney fees and any award of costs, in connection with or arising directly or indirectly out of any act or omission by the Contractor or by any officer, employee, agent, invitee, subcontractor, or sublicensee of the Contractor. Without limiting the foregoing, any and all such claims, suits, or other actions relating to personal injury, death, damage to property, defects in materials or workmanship, actual or alleged violations of any applicable statute, ordinance, administrative order, rule or regulation, or decree of any court shall be included in the indemnity hereunder.

5.09 TERMINATION FOR CAUSE: If, through any cause, the Contractor shall fail to fulfill in a timely and proper manner its obligations under this Agreement, or if the Contractor shall violate any of the provisions of this Agreement, the City may upon written notice to the Contractor terminate the right of the Contractor to proceed under this Agreement, or with such part or parts of the Agreement as to which there has been default, and may hold the Contractor liable for any damages caused to the City by reason of such default and termination. In the event of such termination, any completed services performed by the Contractor under this Agreement shall, at the option of the City, become the City's property and the Contractor shall be entitled to receive equitable compensation for any work completed to the satisfaction of

the City. The Contractor, however, shall not be relieved of liability to the City for damages sustained by the City by reason of any breach of the Agreement by the Contractor, and the City may withhold any payments to the Contractor for the purpose of setoff until such time as the amount of damages due to the City from the Contractor can be determined.

- 5.10 TERMINATION FOR CONVENIENCE:** The City reserves the right, in the City's best interest as determined by the City, to cancel any contract by giving written notice to the Contractor thirty (30) days prior to the effective date of such cancellation.
- 5.11 CANCELLATION FOR UNAPPROPRIATED FUNDS:** The obligation of the City for payment to a Contractor is limited to the availability of funds appropriated in a current fiscal period, and continuation of the contract into a subsequent fiscal period is subject to appropriation of funds, unless otherwise authorized by law.
- 5.12 RECORDS/AUDIT:** The Contractor shall maintain during the term of the contract all books of account, reports and records in accordance with generally accepted accounting practices and standards directly related to this contract. The Contractor agrees to make available to the City Auditor or the City Auditor's designee, during normal business hours and in Broward, Miami-Dade or Palm Beach Counties, all books of account, reports, and records relating to this contract. The Contractor shall retain all books of account, reports, and records relating to this contract for the duration of the contract and for three years after the final payment under this Agreement, until all pending audits, investigations or litigation matters relating to the contract are closed, or until expiration of the records retention period prescribed by Florida law or the records retention schedules adopted by the Division of Library and Information Services of the Florida Department of State, whichever is later.
- 5.13 PERMITS, TAXES, LICENSES:** The successful Contractor shall, at his/her/its own expense, obtain all necessary permits, pay all licenses, fees and taxes, required to comply with all local ordinances, state and federal laws, rules and regulations applicable to business to be carried out under this contract.
- 5.14 LAWS/ORDINANCES:** The Contractor shall observe and comply with all Federal, state, local and municipal laws, ordinances rules and regulations that would apply to this contract.

NON-DISCRIMINATION: The Contractor shall not, in any of its activities, including employment, discriminate against any individual on the basis of race, color, national origin, age, religion, creed, sex, disability, sexual orientation, gender, gender identity, gender expression, marital status, or any other protected classification as defined by applicable law.

1. The Contractor certifies and represents that the Contractor will comply with Section 2-187, Code of Ordinances of the City of Fort Lauderdale, Florida, (2019), as may be amended or revised, ("Section 2-187"), during the entire term of this Agreement.
2. The failure of the Contractor to comply with Section 2-187 shall be deemed to be a material breach of this Agreement, entitling the City to pursue any remedy stated below or any remedy provided under applicable law.
3. The City may terminate this Agreement if the Contractor fails to comply with Section 2-187.
4. The City may retain all monies due or to become due until the Contractor complies with Section 2-187.
5. The Contractor may be subject to debarment or suspension proceedings. Such proceedings will be consistent with the procedures in section 2-183 of the Code of Ordinances of the City of Fort Lauderdale, Florida.

Rev. 2/2020

Page 4

- 5.15 UNUSUAL CIRCUMSTANCES:** If during a contract term where costs to the City are to remain firm or adjustments are restricted by a percentage or CPI cap, unusual circumstances that could not have been foreseen by either party of the contract occur, and those circumstances significantly affect the Contractor's cost in providing the required prior items or services, then the Contractor may request adjustments to the costs to the City to reflect the changed circumstances. The circumstances must be beyond the control of the Contractor, and the requested adjustments must be fully documented. The City may, after examination, refuse to accept the adjusted costs if they are not properly documented, increases are considered to be excessive, or decreases are considered to be insufficient. In the event the City does not wish to accept the adjusted costs and the matter cannot be resolved to the satisfaction of the City, the City will reserve the following options:
1. The contract can be canceled by the City upon giving thirty (30) days written notice to the Contractor with no penalty to the City or Contractor. The Contractor shall fill all City requirements submitted to the Contractor until the termination date contained in the notice.
 2. The City requires the Contractor to continue to provide the items and services at the firm fixed (non-adjusted) cost until the termination of the contract term then in effect.
 3. If the City, in its interest and in its sole opinion, determines that the Contractor in a capricious manner attempted to use this section of the contract to relieve Contractor of a legitimate obligation under the contract, and no unusual circumstances had occurred, the City reserves the right to take any and all action under law or equity. Such action shall include, but not be limited to, declaring the Contractor in default and disqualifying Contractor from receiving any business from the City for a stated period of time.

If the City does agree to adjusted costs, these adjusted costs shall not be invoiced to the City until the Contractor receives notice in writing signed by a person authorized to bind the City in such matters.

- 5.16 ELIGIBILITY:** If applicable, the Contractor must first register with the Florida Department of State in accordance with Florida Statutes, prior to entering into a contract with the City.
- 5.17 PATENTS AND ROYALTIES:** The Contractor, without exception, shall defend, indemnify, and hold harmless the City and the City's employees, officers, employees, volunteers, and agents from and against liability of any nature and kind, including cost and expenses for or on account of any copyrighted, patented or un-patented invention, process, or article manufactured or used in the performance of the contract, including their use by the City. If the Contractor uses any design, device, or materials covered by letters, patent or copyright, it is mutually agreed and understood without exception that the bid prices shall include any and all royalties or costs arising from the use of such design, device, or materials in any way involved in the work.

- 5.18 **ASSIGNMENT:** Contractor shall not transfer or assign the performance required by this ITB without the prior written consent of the City. Any award issued pursuant to this ITB, and the monies, which may become due hereunder, are not assignable except with the prior written approval of the City Commission or the City Manager or City Manager's designee, depending on original award approval.
- 5.19 **GOVERNING LAW; VENUE:** The Contract shall be governed by and construed in accordance with the laws of the State of Florida. Venue for any lawsuit by either party against the other party or otherwise arising out of the Contract, and for any other legal proceeding, shall be in the courts in and for Broward County, Florida, or in the event of federal jurisdiction, in the Southern District of Florida.
- 5.20 **PUBLIC RECORDS:**

IF THE CONTRACTOR HAS QUESTIONS REGARDING THE APPLICATION OF CHAPTER 119, FLORIDA STATUTES, TO THE CONTRACTOR'S DUTY TO PROVIDE PUBLIC RECORDS RELATING TO THIS CONTRACT, CONTACT THE CUSTODIAN OF PUBLIC RECORDS AT PRRCONTRACT@FORTLAUDERDALE.GOV, 954-828-5002, CITY CLERK'S OFFICE, 100 N. ANDREWS AVENUE, FORT LAUDERDALE, FLORIDA 33301.

Contractor shall comply with public records laws, and Contractor shall:

1. Keep and maintain public records required by the City to perform the service.
2. Upon request from the City's custodian of public records, provide the City with a copy of the requested records or allow the records to be inspected or copied within a reasonable time at a cost that does not exceed the cost provided in Chapter 119, Florida Statutes (2019), as may be amended or revised, or as otherwise provided by law.
3. Ensure that public records that are exempt or confidential and exempt from public records disclosure requirements are not disclosed except as authorized by law for the duration of the contract term and following completion of the contract if the Contractor does not transfer the records to the City.
4. Upon completion of the Contract, transfer, at no cost, to the City all public records in possession of the Contractor or keep and maintain public records required by the City to perform the service. If the Contractor transfers all public records to the City upon completion of the Contract, the Contractor shall destroy any duplicate public records that are exempt or confidential and exempt from public records disclosure requirements. If the Contractor keeps and maintains public records upon completion of the Contract, the Contractor shall meet all applicable requirements for retaining public records. All records stored electronically must be provided to the City, upon request from the City's custodian of public records, in a format that is compatible with the information technology systems of the City.

REFERENCES

A minimum of three (3) references shall be provided:

1. Company Name:

Address:

Contact:

Phone #: Email:

Contract Value: Year:

Description:

2. Company Name:

Address:

Contact:

Phone #: Email:

Contract Value: Year:

Description:

3. Company Name:

Address:

Contact:

Phone #: Email:

Contract Value: Year:

Description:

4. **Company Name:**

Address:

Contact:

Phone #: Email:

Contract Value: Year:

Description:

5. **Company Name:**

Address:

Contact:

Phone #: Email:

Contract Value: Year:

Description:

NON-COLLUSION STATEMENT:

By signing this offer, the vendor/contractor certifies that this offer is made independently and *free* from collusion. Vendor shall disclose below any City of Fort Lauderdale, FL officer or employee, or any relative of any such officer or employee who is an officer or director of, or has a material interest in, the vendor's business, who is in a position to influence this procurement.

Any City of Fort Lauderdale, FL officer or employee who has any input into the writing of specifications or requirements, solicitation of offers, decision to award, evaluation of offers, or any other activity pertinent to this procurement is presumed, for purposes hereof, to be in a position to influence this procurement.

For purposes hereof, a person has a material interest if they directly or indirectly own more than 5 percent of the total assets or capital stock of any business entity, or if they otherwise stand to personally gain if the contract is awarded to this vendor.

In accordance with City of Fort Lauderdale, FL Policy and Standards Manual, 6.10.8.3,

3.3. City employees may not contract with the City through any corporation or business entity in which they or their immediate family members hold a controlling financial interest (e.g. ownership of five (5) percent or more).

3.4. Immediate family members (spouse, parents and children) are also prohibited from contracting with the City subject to the same general rules.

Failure of a vendor to disclose any relationship described herein shall be reason for debarment in accordance with the provisions of the City Procurement Code.

NAME

RELATIONSHIPS

In the event the vendor does not indicate any names, the City shall interpret this to mean that the vendor has indicated that no such relationships exist.

Authorized Signature

Title

Name (Printed)

Date

**CONTRACTOR'S CERTIFICATE OF COMPLIANCE WITH
NON-DISCRIMINATION PROVISIONS OF THE CONTRACT**

The completed and signed form should be returned with the Contractor's submittal. If not provided with submittal, the Contractor must submit within three business days of City's request. Contractor may be deemed non-responsive for failure to fully comply within stated timeframes.

Pursuant to City Ordinance Sec. 2-187(c), bidders must certify compliance with the Non-Discrimination provision of the ordinance.

The Contractor shall not, in any of his/her/its activities, including employment, discriminate against any individual on the basis of race, color, national origin, religion, creed, sex, disability, sexual orientation, gender, gender identity, gender expression, or marital status.

1. The Contractor certifies and represents that he/she/it will comply with Section 2-187, Code of Ordinances of the City of Fort Lauderdale, Florida, as amended by Ordinance C-18-33 (collectively, "Section 2-187").
2. The failure of the Contractor to comply with Section 2-187 shall be deemed to be a material breach of this Agreement, entitling the City to pursue any remedy stated below or any remedy provided under applicable law.
3. The City may terminate this Agreement if the Contractor fails to comply with Section 2-187.
4. The City may retain all monies due or to become due until the Contractor complies with Section 2-187.
5. The Contractor may be subject to debarment or suspension proceedings. Such proceedings will be consistent with the procedures in section 2-183 of the Code of Ordinances of the City of Fort Lauderdale, Florida.

Authorized Signature

Print Name and Title

Date

CONTRACT PAYMENT METHOD

The City of Fort Lauderdale has implemented a Procurement Card (P-Card) program which changes how payments are remitted to its vendors. The City has transitioned from traditional paper checks to credit card payments via MasterCard or Visa as part of this program.

This allows you as a vendor of the City of Fort Lauderdale to receive your payments fast and safely. No more waiting for checks to be printed and mailed.

In accordance with the contract, payments on this contract will be made utilizing the City's P-Card (MasterCard or Visa). Accordingly, bidders must presently have the ability to accept these credit cards or take whatever steps necessary to implement acceptance of a card before the start of the contract term, or contract award by the City.

All costs associated with the Contractor's participation in this purchasing program shall be borne by the Contractor. The City reserves the right to revise this program as necessary.

By signing below you agree with these terms.

Please indicate which credit card payment you prefer:

- MasterCard
- Visa

Company Name

Name (Printed)

Signature

Date

Title

LOCAL BUSINESS PREFERENCE

Section 2-199.2, Code of Ordinances of the City of Fort Lauderdale, (Ordinance No. C-12-04), provides for a local business preference.

In order to be considered for a local business preference, a bidder must include the Local Business Preference Certification Statement of this bid/proposal, as applicable to the local business preference class claimed **at the time of bid submittal**.

Upon formal request of the City, based on the application of a Local Business Preference the Bidder shall, within ten (10) calendar days, submit the following documentation to the Local Business Preference Class claimed:

- A) Copy of City of Fort Lauderdale current year business tax receipt, **or** Broward County current year business tax receipt, **and**
- B) List of the names of all employees of the bidder and evidence of employees' residence within the geographic bounds of the City of Fort Lauderdale or Broward County, as the case may be, such as current Florida driver license, residential utility bill (water, electric, telephone, cable television), or other type of similar documentation acceptable to the City.

Failure to comply at time of bid submittal shall result in the bidder being found ineligible for the local business preference.

THE COMPLETE LOCAL BUSINESS PREFERENCE ORDINANCE MAY BE FOUND ON THE CITY'S WEB SITE AT THE FOLLOWING LINK: https://library.municode.com/fl/fort_lauderdale/codes/code_of_ordinances?nodeId=COOR_CH2AD_ARTVFI_DIV2PR_S2-186LOBUPRPR

Definitions: The term "Business" shall mean a person, firm, corporation or other business entity which is duly licensed and authorized to engage in a particular work in the State of Florida. Business shall be broken down into four (4) types of classes:

- 1. Class A Business – shall mean any Business that has established and agrees to maintain a permanent place of business located in a non-residential zone and staffed with full-time employees within the limits of the City **and** shall maintain a staffing level of the prime contractor for the proposed work of at least fifty percent (50%) who are residents of the City.
- 2. Class B Business - shall mean any Business that has established and agrees to maintain a permanent place of business located in a non-residential zone and staffed with full-time employees within the limits of the City **or** shall maintain a staffing level of the prime contractor for the proposed work of at least fifty percent (50%) who are residents of the City.
- 3. Class C Business - shall mean any Business that has established and agrees to maintain a permanent place of business located in a non-residential zone **and** staffed with full-time employees within the limits of Broward County.
- 4. Class D Business – shall mean any Business that does not qualify as either a Class A, Class B, or Class C business.

LOCAL BUSINESS PREFERENCE CERTIFICATION STATEMENT

The Business identified below certifies that it qualifies for the local business preference classification as indicated herein, and further certifies and agrees that it will re-affirm its local preference classification annually no later than thirty (30) calendar days prior to the anniversary of the date of a contract awarded pursuant to this ITB. Violation of the foregoing provision may result in contract termination.

- (1) Business Name is a **Class A** Business as defined in City of Fort Lauderdale Ordinance No. C-17-26, Sec.2-186. A copy of the City of Fort Lauderdale current year Business Tax Receipt **and** a complete list of full-time employees and evidence of their addresses shall be provided within 10 calendar days of a formal request by the City.
- (2) Business Name is a **Class B** Business as defined in the City of Fort Lauderdale Ordinance No. C-17-26, Sec.2-186. A copy of the Business Tax Receipt **or** a complete list of full-time employees and evidence of their addresses shall be provided within 10 calendar days of a formal request by the City.
- (3) Business Name is a **Class C** Business as defined in the City of Fort Lauderdale Ordinance No. C-17-26, Sec.2-186. A copy of the Broward County Business Tax Receipt shall be provided within 10 calendar days of a formal request by the City.
- (4) Business Name requests a **Conditional Class A** classification as defined in the City of Fort Lauderdale Ordinance No. C-17-26, Sec.2-186. Written certification of intent shall be provided within 10 calendar days of a formal request by the City.
requests a **Conditional Class B** classification as defined in the City of Fort Lauderdale

(5)
Business Name

Ordinance No. C-17-26, Sec.2-186. Written certification of intent shall be provided within 10 calendar days of a formal request by the City.

(6)
Business Name

is considered a **Class D** Business as defined in the City of Fort Lauderdale Ordinance No. C-17-26, Sec.2-186 and does not qualify for Local Preference consideration.

BIDDER'S COMPANY:

AUTHORIZED
COMPANY
PERSON:

PRINTED NAME

TITLE

SIGNATURE:

DATE:

E-VERIFY AFFIRMATION STATEMENT

RFP/Bid /Contract No:

Project Description:

Contractor/Proposer/Bidder acknowledges and agrees to utilize the U.S. Department of Homeland Security's E-Verify System to verify the employment eligibility of,

- (a) all persons employed by Contractor/Proposer/Bidder to perform employment duties within Florida during the term of the Contract, and,
- (b) all persons (including subcontractors/vendors) assigned by Contractor/Proposer/Bidder to perform work pursuant to the Contract.

The Contractor/Proposer/Bidder acknowledges and agrees that use of the U.S. Department of Homeland Security's E-Verify System during the term of the Contract is a condition of the Contract.

Contractor/Proposer/ Bidder Company Name:

Authorized Company Person's Signature:

Authorized Company Person's Title:

Date:

9/15/2020

BID/PROPOSAL CERTIFICATION

Please Note: It is the sole responsibility of the bidder to ensure that his bid is submitted electronically through www.BidSync.com prior to the bid opening date and time listed. Paper bid submittals will not be accepted. All fields below must be completed. If the field does not apply to you, please note N/A in that field.

If you are a foreign corporation, you may be required to obtain a certificate of authority from the department of state, in accordance with Florida Statute §607.1501 (visit http://www.dos.state.fl.us/).

Company: (Legal Registration) EIN (Optional):

Address:

City: State: Zip:

Telephone No.: FAX No.: Email:

Delivery: Calendar days after receipt of Purchase Order (**section 1.02 of General Conditions**):

Total Bid Discount (**section 1.05 of General Conditions**):

Check box if your firm qualifies for MBE / SBE / WBE (**section 1.09 of General Conditions**):

ADDENDUM ACKNOWLEDGEMENT - Proposer acknowledges that the following addenda have been received and are included in the proposal:

<u>Addendum No.</u>	<u>Date Issued</u>	<u>Addendum No.</u>	<u>Date Issued</u>	<u>Addendum No.</u>	<u>Date Issued</u>
<input type="text"/>	<input type="text"/>	<input type="text"/>	<input type="text"/>	<input type="text"/>	<input type="text"/>
<input type="text"/>	<input type="text"/>	<input type="text"/>	<input type="text"/>	<input type="text"/>	<input type="text"/>

VARIANCES: If you take exception or have variances to any term, condition, specification, scope of service, or requirement in this competitive solicitation you must specify such exception or variance in the space provided below or reference in the space provided below all variances contained on other pages within your response. Additional pages may be attached if necessary. No exceptions or variances will be deemed to be part of the response submitted unless such is listed and contained in the space provided below. The City does not, by virtue of submitting a variance, necessarily accept any variances. If no statement is contained in the below space, it is hereby implied that your response is in full compliance with this competitive solicitation. If you do not have variances, simply mark N/A. **You must also click the "Take Exception" button.**

The below signatory hereby agrees to furnish the following article(s) or services at the price(s) and terms stated subject to all instructions, conditions, specifications addenda, legal advertisement, and conditions contained in the bid/proposal.

I have read all attachments including the specifications and fully understand what is required. By submitting this signed proposal, I will accept a contract if approved by the City and such acceptance covers all terms, conditions, and specifications of this bid/proposal. The below signatory also hereby agrees, by virtue of submitting or attempting to submit a response, that in no event shall the City's liability for respondent's direct, indirect, incidental, consequential, special or exemplary damages,

expenses, or lost profits arising out of this competitive solicitation process, including but not limited to public advertisement, bid conferences, site visits, evaluations, oral presentations, or award proceedings exceed the amount of Five Hundred Dollars (\$500.00). This limitation shall not apply to claims arising under any provision of indemnification or the City's protest ordinance contained in this competitive solicitation.

Submitted by:

Name (printed)

Signature

Date

Title

Revised 4/28/2020

Question and Answers for Bid #12493-512 - Fence, Chain Link and Picket, Annual Contract

Overall Bid Questions

Question 1

- 1.- Is there a Budget for this Project?
- 2.- What is the anticipated start date for this Project?
- 3.- Will there be a Public Bid opening?
- 4.- What is the job location? **(Submitted: Feb 15, 2021 10:13:09 AM EST)**

Answer

- 1. No
2. Refer to Section 2.35 of solicitation
3. No, Bid tab will be available on BidSync as soon as it's opened. If you wish to watch electronic opening via Zoom, please advise.
4. This is a City-wide as-needed annual contract. **(Answered: Feb 16, 2021 9:11:08 AM EST)**