

**BOBCAT COMPANY SUGGESTED PRICE LIST - 4-1-2015**

# Bobcat Company



*Florida State Contract*

**CLARK EQUIPMENT COMPANY dba BOBCAT COMPANY  
250 EAST BEATON DRIVE  
PO BOX 6000  
WEST FARGO, ND 58078-6000**

**TOLL FREE #: 800-965-4232, Opt#2  
FAX#: 701-280-7860 or 701-241-8704**

**PROMPT PAYMENT TERMS: Net 30  
TIME OF DELIVERY: 90 Days ARO  
COMMERCIAL CREDIT CARD: Accepted (Visa/Mastercard/American Express)**

**TID#: 38-0425350**

**PAYMENT ADDRESS:  
CLARK EQUIPMENT COMPANY dba BOBCAT COMPANY  
75 REMITTANCE DR, SUITE 1130  
CHICAGO, IL 60675-1130**

<b>Product</b>	<b>Discount Percent</b>
<b>SSL</b>	<b>30.0%</b>
<b>CTL</b>	<b>30.0%</b>
<b>AWS</b>	<b>30.0%</b>
<b>Loader Attachments</b>	<b>24.0%</b>
<b>MX (Excavators)</b>	<b>30.0%</b>
<b>MX - E63/E85</b>	<b>24.0%</b>
<b>MX Attachments</b>	<b>24.0%</b>
<b>Versahandler</b>	<b>24.0%</b>
<b>VH Attachments</b>	<b>24.0%</b>

- 2-1-15 - Updated 3600/3650 PNs-prices
- 3-1-15 - updated some additions
- 3-5-15 - 8811 deleted
- 3-10-15 - removal of certain backhoes from Ldr Attach list
- 3-29-15 - Added S740 and Tier 4 machine pricing chged
- 4-28-15 - E26 - PN and some opt price changes and opt additions





Part Number	Skid Steer Loader Description	SLP in US\$	Discount Percent
M0041	<b>S70 Bobcat Skid-Steer Loader (equipped with T4 engine)</b>	\$20,323.00	30.0%



Part Number	Factory Installed Options Description	SLP in US\$	Discount Percent
M0041-R02-C02	<b>Cab Enclosure with Heater and Sound Reduction</b> Includes Heater, Front Door with Wiper, Top and Side Sliding Windows, Side Instrument Panel and Sound Reducing Foam Insulation.	\$1,750.00	30.0%
M0041-A01-C04	<b>Sound Reduction Option</b> Includes Sound Reducing Foam Insulation, Top Window and Rear Portion of Side Windows.	\$220.00	30.0%
M0041-R05-C03	<b>Suspension Seat</b>	\$185.00	30.0%
M0041-R09-C02	<b>23x 8.50-12, 6 PR, Heavy Duty Tires</b> Set of four tires in place of base equipment. Loader width 44"	\$185.00	30.0%

Part Number	Skid Steer Loader Description	SLP in US\$	Discount Percent
M0201	<b>S450 Bobcat Skid-Steer Loader (equipped with T4 engine)</b>	\$33,085.00	30.0%



Part Number	Air Conditioned/Heated Cab Packages Description	SLP in US\$	Discount Percent
-------------	---	-------------	------------------

M__-P01-A51	<b>A51 Option Package</b>	\$4,828.00	30.0%
-	<u>A51</u> Enclosed Cab with AC/Heat Suspension Seat Cab Accessories Package* Power Bob-Tach	-	

Part Number	Heated Cab Packages Description	SLP in US\$	Discount Percent
-------------	---------------------------------	-------------	------------------

M__-P01-H51	<b>H51 Option Package</b>	\$3,393.00	30.0%
-	<u>H51</u> Enclosed Cab with Heat Suspension Seat Cab Accessories Package* Power Bob-Tach	-	

Part Number	Open Cab Packages Description	SLP in US\$	Discount Percent
-------------	-------------------------------	-------------	------------------

M__-P01-O31	<b>O31 Option Package</b>	\$797.00	30.0%
-	<u>O31</u> Suspension Seat Cab Accessories Package*	-	

\*Cab Accessories Pkg Incls: Deluxe Headliner with Dome Light, Cab Accessory Harness, Power Port, Lower Interior Panels with Storage Compartments and cup holder.

Part Number	Factory Installed Options Description	SLP in US\$	Discount Percent
-------------	---------------------------------------	-------------	------------------

	<u>Controls</u>		
M__-R01-C03	<b>Advanced Control System (ACS)*</b> Allows operator to select either hand or foot control of lift and tilt functions.	\$1,401.00	30.0%
M__-R01-C04	<b>Selectable Joystick Control (SJC)</b>	\$2,660.00	30.0%

Standard features include: Selectable patterns (ISO or H-Pattern), Horsepower Management, Speed Management, Drive Response and Foot Pedal for Engine Speed Control. **MUST**  
**ORDER** Cab Option Pkg

M\_\_-R80-C02      **\*IF a Cab Option Pkg is not ordered, a Cab Accessories Pkg must be ordered with Advanced Control System (ACS)**      **\$395.00**      **30.0%**

***Tire Options***

*(Set of 4 Tires in Place of Base Equipment)*

M\_\_-R09-C14      **7.00-15, 8 PR Narrow Tire (Loader width 53.4")**      **\$95.00**      **30.0%**

Part Number	Skid Steer Loader Description	SLP in US\$	Discount Percent
M0251	<b>S510 Skid Steer Loader (equipped with Final Tier 4 engine)</b>	\$33,883.00	30.0%
M0257	<b>S530 Skid Steer Loader (equipped with Final Tier 4 engine)</b>	\$35,435.00	30.0%



Part	Heated Cab Packages	SLP in US\$	Discount Percent
------	---------------------	-------------	------------------

Number	Description	SLP in US\$	Discount Percent
--------	-------------	-------------	------------------

M_-P01-H51	H51 Option Package	\$3,393.00	30.0%
------------	--------------------	------------	-------

**H51**

Enclosed Cab with Heat  
 Suspension Seat  
 Cab Accessories Package\*  
 Power Bob-Tach

Part Number	Open Cab Packages Description	SLP in US\$	Discount Percent
-------------	-------------------------------	-------------	------------------

M_-P01-O71	O71 Option Package	\$2,305.00	30.0%
M_-P01-O51	O51 Option Package	\$1,397.00	30.0%
M_-P01-O31	O31 Option Package	\$797.00	30.0%

**O31**  
 Suspension Seat  
 Cab Accessories Pkg\*

**O51**  
 Suspension Seat  
 Cab Accessories Package\*  
 Deluxe Instrument Panel with Keyless Start

**O71**  
 Suspension Seat  
 Cab Accessories Pkg\*  
 Deluxe Instrument Panel  
 with Keyless Start  
 Power Bob-Tach  
 Attachment Control Kit

*\*Cab Accessories Package : Deluxe Headliner with Dome Light, Cab Accessory  
 Harness, Power Port, Lower Interior Panels with Storage Compartments, and Cup*

Part	Factory Installed Options	SLP in US\$	Discount Percent
------	---------------------------	-------------	------------------

Number	Description		
<b><u>Controls</u></b>			
M__-R01-C03	<b>Advanced Control System (ACS)*</b> Allows operator to select either hand or foot control of lift and tilt functions.	\$1,401.00	30.0%
M__-R01-C04	<b>Selectable Joystick Control (SJC)</b> Standard features include: Selectable patterns (ISO or H-Pattern), Horsepower Management, Speed Management, Drive Response and Foot Pedal for Engine Speed Control. <b><u>MUST</u></b> <b><u>ORDER</u></b> Cab Option Pkg	\$2,195.00	30.0%
M__-R80-C02	<b>*IF a Cab Option Pkg is not ordered, a Cab Accessories Pkg must be ordered with ACS</b>	\$415.00	30.0%
<b><u>Other Factory Installed Options</u></b>			
M__-R28-C02	<b>7 Pin Attachment Control Kit</b> Kit is included in H71 Opt Pkg	\$205.00	30.0%
M__-P03-F20	<b>Two Speed, Engine Block Heater</b>	\$1,741.00	30.0%
M__-P03-F30	<b>Two Speed, Hydraulic Bucket Positioning, Cold Weather Pkg</b>	\$2,197.00	30.0%
M__-R11-C02	<b>Hydraulic Bucket Positioning</b> Bucket Positioning helps the operator to keep the same tilt of the load during lifting. Includes On/Off switch.	\$468.00	30.0%
M__-R05-C03	<b>Suspension Seat - Required for Two Speed if not ordering a "Cab Opt Pkg".</b>	\$499.00	30.0%
M__-R31-C02	<b>Cold Weather Pkg (Incls Eng Block Heater and Larger Battery (950 cca))</b>	\$200.00	30.0%
M__-R05-C11	<b>Air Ride Suspension Seat</b> Must order a Cab Option package.	\$314.00	30.0%
M__-R26-C02	<b>Radio</b> Must order a Cab Option package. Includes weatherproof AM/FM/NOAA Weather Band Radio, Speakers, and Antenna. Works with MP3 or other portable music player.	\$417.00	30.0%
<b><u>Tire Options</u></b> (Set of 4 Tires in Place of Base Equipment)			
M__-R09-C02	<b>10-16.5, 10 Pr, Bobcat Heavy Duty Tires</b>	\$247.00	30.0%
M__-R09-C03	<b>10-16.5, 10 Pr, Bobcat Heavy Duty Tires Offset</b>	\$289.00	30.0%
M__-R09-C04	<b>10-16.5, 10 Pr, Bobcat Severe Duty Tires</b>	\$929.00	30.0%
M__-R09-C05	<b>10-16.5, 10 Pr, Bobcat Severe Duty-Poly Fill Tires</b>	\$1,544.00	30.0%
M__-R09-C06	<b>31 x 12-16.5, 10 PR, Bobcat Heavy Duty Wide Flotation Tires</b>	\$582.00	30.0%

Part	Skid Steer Loader	SLP in US\$	Discount Percent
------	-------------------	-------------	------------------

Number	Description	SLP in US\$	Discount Percent
M0253	S550 Skid Steer Loader (equipped with Final Tier 4 engine)	\$37,123.00	30.0%
M0259	S570 Skid Steer Loader (equipped with Final Tier 4 engine)	\$39,192.00	30.0%
M0261	S590 Skid Steer Loader (equipped with Final Tier 4 engine)	\$40,519.00	30.0%



Part Number	Air Conditioned/Heated Cab Packages Description	SLP in US\$	Discount Percent
M__-P01-A91	A91 Option Package	\$9,788.00	30.0%
M__-P01-A71	A71 Option Package	\$6,165.00	30.0%
M__-P01-A51	A51 Option Package	\$4,930.00	30.0%
M__-P01-A31	A31 Option Package	\$4,295.00	30.0%
<b><u>A31</u></b>	<b><u>A51</u></b>	<b><u>A71</u></b>	<b><u>A91</u></b>
Enclosed Cab with AC/Heat	Enclosed Cab with AC/Heat	Enclosed Cab with AC/Heat	Enclosed Cab with AC/Heat
Cab Accessories Package*	Cab Accessories Package*	Cab Accessories Pkg*	Cab Accessories Pkg*
Suspension Seat	Power Bob-Tach	Power Bob-Tach	Power Bob-Tach
		Sound Reduction	Sound Reduction
		Deluxe Instrument Panel w/Keyless Start	Deluxe Instrument Panel w/Keyless Start
		Attachment Control Kit	Attachment Control High Flow Hydraulics
			Hydraulic Bucket Positioning
			Cold Weather Pkg

Part Number	Heated Cab Packages Description	SLP in US\$	Discount Percent
-------------	---------------------------------	-------------	------------------



M__-P01-H51	<b>H51 Option Package</b>	<b>\$3,495.00</b>	<b>30.0%</b>
-------------	---------------------------	-------------------	--------------

**H51**

Enclosed Cab with Heat  
 Suspension Seat  
 Cab Accessories Package\*  
 Power Bob-Tach

Part Number	Open Cab Packages Description	SLP in US\$	Discount Percent
-------------	-------------------------------	-------------	------------------

M__-P01-O71	<b>O71 Option Package</b>	<b>\$2,373.00</b>	<b>30.0%</b>
-------------	---------------------------	-------------------	--------------

M__-P01-O51	<b>O51 Option Package</b>	<b>\$1,440.00</b>	<b>30.0%</b>
-------------	---------------------------	-------------------	--------------

M__-P01-O31	<b>O31 Option Package</b>	<b>\$822.00</b>	<b>30.0%</b>
-------------	---------------------------	-----------------	--------------

**O31**  
 Suspension Seat  
 Cab Accessories Package\*

**O51**  
 Suspension Seat  
 Cab Accessories Package\*  
 Deluxe Instrument Panel with Keyless Start

**O71**  
 Suspension Seat  
 Cab Accessories Pkg\*  
 Deluxe Instrument Panel  
 w/Keyless Start  
 Power Bob-Tach  
 Attachment Control Kit

*\*Cab Accessories Package: Deluxe Headliner with Dome Light, Cab Accessory Harness, Power Port, Lower Interior Panels with Storage Compartments, and Cup*

Part	Factory Installed Options	SLP in US\$	Discount Percent
------	---------------------------	-------------	------------------

Number	Description		
	<u><b>Controls</b></u>		
M__-R01-C03	<b>Advanced Control System (ACS)</b> Allows operator to select either hand or foot control of lift and tilt functions.	\$1,401.00	30.0%
M__-R01-C04	<b>Selectable Joystick Control (SJC)</b> Standard features include: Selectable patterns (ISO or H-Pattern), Horsepower Management, Speed Management, Drive Response and Foot Pedal for Engine Speed Control. <u><b>MUST</b></u> <u><b>ORDER</b></u> Cab Option Pkg	\$2,195.00	30.0%
M__-R80-C02	<b>Cab Accessories Pkg - *IF a Cab Option Pkg is not ordered, this must be ordered with ACS</b>	\$415.00	30.0%
	<u><b>Other Factory Installed Options</b></u>		
M__-R05-C11	<b>Air Ride Suspension Seat</b> Must order a Cab Option package.	\$314.00	30.0%
M__-R26-C02	<b>Radio</b> Must order a Cab Option package. Includes weatherproof AM/FM/NOAA Weather Band Radio, Speakers, and Antenna. Works with MP3 or other portable music player.	\$417.00	30.0%
M__-R03-C03	<b>High Flow Hydraulics</b> Provides 26.7 GPM and 3500 PSI for attachment operation. The 7 pin attachment control kit is required.	\$1,571.00	30.0%
M__-R28-C02	<b>Attachment 7 Pin Control Kit</b> Required when ordering High Flow Hydraulics. Kit is included in A91, A71, H71 & O71 Opt Pkgs	\$205.00	30.0%
M__-P03-F50	<b>High Flow Hydraulics, Two Speed, Hydraulic Bucket Positioning, Cold Weather Package</b>	\$3,732.00	30.0%
M__-R04-C02	<b>Two Speed</b> Includes 2-speed motors and 3-Point Seat Belt. Low Travel Speed 7.4 MPH, High Travel Speed 11.0 MPH. Suspension Seat is required.	\$1,582.00	30.0%
M__-R05-C03	<b>Suspension Seat with Three Point Belt</b> Required if not ordering a Cab Opt Pkg when ordering Two Speed Option	\$499.00	30.0%
M__-P03-F20	<b>Two Speed, Cold Weather Package</b>	\$1,741.00	30.0%
M__-P03-F30	<b>Two Speed, Hydraulic Bucket Positioning, Cold Weather Package</b>	\$2,197.00	30.0%
M__-R11-C02	<b>Hydraulic Bucket Positioning</b> Bucket Positioning helps the operator to keep the same tilt of the load during lifting. Includes On/Off switch.	\$468.00	30.0%
M__-R31-C02	<b>Cold Weather Pkg (Incls Eng Block Heater and Larger Battery (950 cca))</b>	\$200.00	30.0%



Enclosed Cab with AC/Heat	Enclosed Cab with AC/Heat	Enclosed Cab with AC/Heat
Suspension Seat	Suspension Seat	Suspension Seat
Cab Accessories Package*	Cab Accessories Package*	Cab Accessories Pkg*
<u>A51</u>	Power Bob-Tach	Power Bob-Tach
Enclosed Cab with AC/Heat	Sound Reduction	Sound Reduction
Suspension Seat	Deluxe Instrument Panel with Keyless Start	Deluxe Instrument Panel with Keyless Start
Cab Accessories Package*	Attachment Control Kit	Attachment Control Kit
Power Bob-Tach		High Flow Hydraulics
		Two Speed with 3-Point Belt
		Hydraulic Bucket Positioning
		Engine Block Heater

Part Number	Heated Cab Packages Description	SLP in US\$	Discount Percent
M__-P01-H51	<b>H51 Option Package</b>	<b>\$3,600.00</b>	<b>30.0%</b>
	<u>H51</u> Enclosed Cab with Heat Suspension Seat Cab Accessories Package* Power Bob-Tach		

Part Number	Open Cab Packages Description	SLP in US\$	Discount Percent
M__-P01-O71	<b>O71 Option Package</b>	<b>\$2,443.00</b>	<b>30.0%</b>
M__-P01-O51	<b>O51 Option Package</b>	<b>\$1,484.00</b>	<b>30.0%</b>
M__-P01-O31	<b>O31 Option Package</b>	<b>\$848.00</b>	<b>30.0%</b>
<u>O31</u> Suspension Seat Cab Accessories Package*	<u>O51</u> Suspension Seat Cab Accessories Package* Deluxe Instrument Panel with Keyless Start	<u>O71</u> Suspension Seat Cab Accessories Pkg* Deluxe Instrument Panel with Keyless Start	

Power Bob-Tach  
Attachment Control Kit

*\*Cab Accessories Package : Deluxe Headliner with Dome Light, Cab Accessory Harness, Power Port, Lower Interior Panels with Storage Compartments, and Cup Holder.*

Part Number	Factory Installed Options Description	SLP in US\$	Discount Percent
	<u>Controls</u>		
M__-R01-C03	<b>Advanced Control System (ACS)</b> Allows operator to select either hand or foot control of lift and tilt functions. .	\$1,504.00	30.0%
M__-R01-C04	<b>Selectable Joystick Control (SJC)</b> Standard features include: Selectable patterns (ISO or H-Pattern), Horsepower Management, Speed Management, Drive Response and Foot Pedal for Engine Speed Control. <b><u>MUST ORDER</u></b> a Cab Pkg	\$2,395.00	30.0%
	<b>*IF a Cab Option Pkg is not ordered, a Cab Accessories Pkg must be ordered with ACS</b>	\$415.00	30.0%
	<u>Tire Options</u>		
	<i>(Set of 4 Tires in Place of Base Equipment)</i>		
M__-R09-C03	<b>12-16.5, 12 Pr, Bobcat Heavy Duty Tires Offset</b> Loader width 68"	\$85.00	30.0%
M__-R09-C04	<b>12-16.5, 12 Pr, Bobcat Severe Duty Tires</b> Loader width 72"	\$840.00	30.0%
M__-R09-C05	<b>12-16.5, 12 Pr, Bobcat Severe Duty-Poly Fill Tires</b> Loader width 72"	\$1,654.00	30.0%
M__-R09-C11	<b>33 x 15.5-16.5, 12 PR, Bobcat Super Float Tires- Offset Rims</b> Loader width 74"	\$882.00	30.0%
	<u>Factory Installed Options</u>		
M__-R05-C11	<b>Air Ride Suspension Seat</b> Must order an A,H or O cab package.	\$314.00	30.0%
M__-R26-C02	<b>Radio</b> Must order an A,H or O cab package. Includes weatherproof AM/FM/NOAA Weather Band Radio, Speakers, and Antenna. Works with MP3 or other portable music player.	\$417.00	30.0%
M__-R03-C03	<b>High Flow Hydraulics</b> Provides 30.5 GPM and 3500 PSI for attachment operation.	\$1,883.00	30.0%

<b>M__-R28-C02</b>	<b>Attachment 7 Pin Control Kit</b> Required when ordering High Flow Hydraulics. Kit is included in A91, A71, H71 & O71 Opt Pkgs	<b>\$205.00</b>	<b>30.0%</b>
<b>M__-P03-F50</b>	<b>High Flow Hydraulics, Two Speed, Hydraulic Bucket Positioning, Engine Block Heater</b>	<b>\$3,950.00</b>	<b>30.0%</b>
<b>M__-R04-C02</b>	<b>Two Speed</b> Includes 2-speed motors and Spring Applied/Pressure Release (SAPR) Brake. Low Travel Speed 7.1 MPH, High Travel Speed 12.3 MPH. When ordering 2 speed option, the Bobcat Ordering systems will automatically add the Suspension Seat with 3 Point Belt if the Two Speed Option is ordered; unless you are ordering a Cab Option Package which includes the suspension seat	<b>\$1,582.00</b>	<b>30.0%</b>
<b>M__-R05-C03</b>	<b>Suspension Seat with Three Point Belt</b> Required if not ordering a Cab Opt Pkg when ordering Two Speed Option	<b>\$499.00</b>	<b>30.0%</b>
<b>M__-P03-F30</b>	<b>Two Speed, Hydraulic Bucket Positioning, Engine Block Heater</b>	<b>\$2,111.00</b>	<b>30.0%</b>
<b>M__-P03-F20</b>	<b>Two Speed, Engine Block Heater</b>	<b>\$1,654.00</b>	<b>30.0%</b>
<b>M__-R11-C02</b>	<b>Hydraulic Bucket Positioning</b> Bucket Positioning helps the operator to keep the same tilt of the load during lifting. Includes On/Off switch	<b>\$468.00</b>	<b>30.0%</b>
<b>M__-A01-C02</b>	<b>Engine Block Heater</b>	<b>\$111.00</b>	<b>30.0%</b>
<b>M__-P03-F10</b>	<b>Hydraulic Bucket Positioning, Engine Block Heater</b>	<b>\$566.00</b>	<b>30.0%</b>

Part Number	Skid Steer Loader Description	SLP in US\$	Discount Percent
M0275	<b>S740 Skid Steer Loader (equipped with Final Tier 4 engine)</b>	\$49,990.00	30.0%



Part Number	Air Conditioned/Heated Cab Packages Description	SLP in US\$	Discount Percent
M__-P01-A91	A91 Option Package	\$10,137.00	30.0%
M__-P01-A71	A71 Option Package	\$6,349.00	30.0%
M__-P01-A51	A51 Option Package	\$5,076.00	30.0%
M__-P01-A31	A31 Option Package	\$4,425.00	30.0%

<u>A31</u>	<u>A71</u>	<u>A91</u>
Enclosed Cab with AC/Heat	Enclosed Cab with AC/Heat	Enclosed Cab with AC/Heat
Suspension Seat	Suspension Seat	Suspension Seat
Cab Accessories Package*	Cab Accessories Package*	Cab Accessories Pkg*
	Power Bob-Tach	Power Bob-Tach
	Sound Reduction	Sound Reduction
<u>A51</u>	Deluxe Instrument Panel with Keyless Start	Deluxe Instrument Panel with Keyless Start
Enclosed Cab with AC/Heat	Attachment Control Kit	Attachment Control Kit
Suspension Seat		High Flow Hydraulics
Cab Accessories Package*		Two Speed with 3 Point Belt
Power Bob-Tach		Hydraulic Bucket Positioning
		Engine Block Heater

Part Number	Heated Cab Packages Description	SLP in US\$	Discount Percent
-------------	---------------------------------	-------------	------------------

M__-P01-H51	<b>H51 Option Package</b>	<b>\$3,600.00</b>	<b>30.0%</b>
-------------	---------------------------	-------------------	--------------

**H51**

Enclosed Cab with Heat  
 Suspension Seat  
 Cab Accessories Package\*  
 Power Bob-Tach

Part Number	Open Cab Packages Description	SLP in US\$	Discount Percent
-------------	-------------------------------	-------------	------------------

M__-P01-O71	<b>O71 Option Package</b>	<b>\$2,443.00</b>	<b>30.0%</b>
M__-P01-O51	<b>O51 Option Package</b>	<b>\$1,484.00</b>	<b>30.0%</b>
M__-P01-O31	<b>O31 Option Package</b>	<b>\$848.00</b>	<b>30.0%</b>

**O31**

Suspension Seat  
 Cab Accessories Package\*

**O51**

Suspension Seat  
 Cab Accessories Package\*  
 Deluxe Instrument Panel with Keyless Start

**O71**

Suspension Seat  
 Cab Accessories Pkg\*  
 Deluxe Instrument Panel  
 with Keyless Start  
 Power Bob-Tach  
 Attachment Control Kit

*\*Cab Accessories Package: Deluxe Headliner with Dome Light, Cab Accessory Harness, Power Port, Lower Interior Panels with Storage Compartments, and Cup*

Part Number	Factory Installed Options Description	SLP in US\$	Discount Percent
-------------	---------------------------------------	-------------	------------------

**Controls**

M__-R01-C03	<b>Advanced Control System (ACS)</b> Allows operator to select either hand or foot control of lift and tilt functions.	<b>\$1,504.00</b>	<b>30.0%</b>
M__-R01-C04	<b>Selectable Joystick Control (SJC)</b> Standard features include: Selectable patterns (ISO or H-Pattern), Horsepower Management, Speed Management, Drive Response and Foot Pedal for Engine Speed Control. <b><u>MUST ORDER</u></b> a Cab Opt Pkg	<b>\$2,395.00</b>	<b>30.0%</b>
	<b>*IF a Cab Option Pkg is not ordered, a Cab Accessories Pkg must be ordered with ACS</b>	<b>\$415.00</b>	<b>30.0%</b>

**Tire Options**

*(Set of 4 Tires in Place of Base Equipment)*



M__-R09-C03	<b>12-16.5, 12 Pr, Bobcat Heavy Duty Tires Offset</b> Loader width 68.5"	\$85.00	30.0%
M__-R09-C04	<b>12-16.5, 12 Pr, Bobcat Severe Duty Tires</b> Loader width 72.1"	\$840.00	30.0%
M__-R09-C05	<b>12-16.5, 12 Pr, Bobcat Severe Duty-Poly Fill Tires</b> Loader width 72.1"	\$1,654.00	30.0%
M__-R09-C11	<b>33 x 15.5-16.5, 12 PR, Bobcat Super Float Tires- Offset Rims</b> Loader width 72.1"	\$882.00	30.0%
<b><u>Other Factory Installed Options</u></b>			
M__-R05-C11	<b>Air Ride Suspension Seat</b> Must order a Cab Option package.	\$314.00	30.0%
M__-R26-C02	<b>Radio</b> Must order a Cab Option package. Includes weatherproof AM/FM/NOAA Weather Band Radio, Speakers, and Antenna. Works with MP3 or other portable music player.	\$417.00	30.0%
M__-R03-C03	<b>High Flow Hydraulics</b> Provides 36.5 GPM and 3500 PSI for attachment operation. When ordering High Flow Hydraulics, the Bobcat Ordering systems will automatically add the 7 Pin Attachment Control Kit. Unless you are ordering an A71, H71 or O71 Cab Package that includes the Attachment Control Kit.	\$1,883.00	30.0%
M__-R28-C02	<b>Attachment 7 Pin Control Kit</b> Required when ordering High Flow Hydraulics. Kit is included in A91, A71, H71 & O71 Opt Pkgs	\$205.00	30.0%
M__-P03-F50	<b>High Flow Hydraulics, Two Speed, Hydraulic Bucket Positioning, Engine Block Heater</b>	\$3,950.00	30.0%
M__-R04-C02	<b>Two Speed</b> Includes 2-speed motors and Spring Applied/Pressure Release (SAPR) Brake. Low Travel Speed 7.1 MPH, High Travel Speed 12.3 MPH. When ordering 2 Speed option, the Bobcat Ordering systems will automatically add the Suspension seat with 3 point seat belt; Unless you are ordering a Cab Option Package which includes the suspension seat.	\$1,582.00	30.0%
M__-R05-C03	<b>Suspension Seat with Three Point Belt - Required if ordering a Two-Speed with No Cab Option Pkg</b>	\$499.00	30.0%
M__-P03-F20	<b>Two Speed, Engine Block Heater</b>	\$1,654.00	30.0%
M__-P03-F30	<b>Two Speed, Hydraulic Bucket Positioning, Engine Block Heater</b>	\$2,111.00	30.0%
M__-R11-C02	<b>Hydraulic Bucket Positioning</b> Bucket Positioning helps the operator to keep the same tilt of the load during lifting. Includes On/Off switch.	\$468.00	30.0%
M__-A01-C02	<b>Engine Block Heater</b>	\$111.00	30.0%

M\_\_-P03-F10 Hydraulic Bucket Positioning, Engine Block Heater \$566.00 30.0%

Part Number	Skid Steer Loader Description	SLP in US\$	Discount Percent
M0279	S750 Skid Steer Loader (equipped with Final Tier 4 engine)	\$55,329.00	30.0%
M0283	S770 Skid Steer Loader (equipped with Final Tier 4 engine)	\$56,953.00	30.0%



Part Number	Air Conditioned/Heated Cab Packages Description	SLP in US\$	Discount Percent
M__-P01-A91	A91 Option Package	\$10,137.00	30.0%
M__-P01-A71	A71 Option Package	\$6,349.00	30.0%
M__-P01-A51	A51 Option Package	\$5,076.00	30.0%
M__-P01-A31	A31 Option Package	\$4,425.00	30.0%

<u>A31</u>	<u>A71</u>	<u>A91</u>
Enclosed Cab with AC/Heat	Enclosed Cab with AC/Heat	Enclosed Cab with AC/Heat
Suspension Seat	Suspension Seat	Suspension Seat
Cab Accessories Package*	Cab Accessories Package*	Cab Accessories Pkg*
	Power Bob-Tach	Power Bob-Tach
	Sound Reduction	Sound Reduction
<u>A51</u>	Deluxe Instrument Panel with Keyless Start	Deluxe Instrument Panel with Keyless Start
Enclosed Cab with AC/Heat	Attachment Control Kit	Attachment Control Kit
Suspension Seat		High Flow Hydraulics
Cab Accessories Package*		Two Speed with 3 Point Belt
Power Bob-Tach		Hydraulic Bucket Positioning
		Engine Block Heater

Part Number	Heated Cab Packages Description	SLP in US\$	Discount Percent
-------------	---------------------------------	-------------	------------------

M__-P01-H51	<b>H51 Option Package</b>	<b>\$3,600.00</b>	<b>30.0%</b>
	<u>H51</u> Enclosed Cab with Heat Suspension Seat Cab Accessories Package* Power Bob-Tach		

Part Number	Open Cab Packages Description	SLP in US\$	Discount Percent
-------------	-------------------------------	-------------	------------------

M__-P01-O71	<b>O71 Option Package</b>	<b>\$2,443.00</b>	<b>30.0%</b>
M__-P01-O51	<b>O51 Option Package</b>	<b>\$1,484.00</b>	<b>30.0%</b>
M__-P01-O31	<b>O31 Option Package</b>	<b>\$848.00</b>	<b>30.0%</b>

<u>O31</u> Suspension Seat Cab Accessories Package*	<u>O51</u> Suspension Seat Cab Accessories Package* Deluxe Instrument Panel with Keyless Start	<u>O71</u> Suspension Seat Cab Accessories Pkg* Deluxe Instrument Panel with Keyless Start Power Bob-Tach Attachment Control Kit	
*Cab Accessories Package : Deluxe Headliner with Dome Light, Cab Accessory Harness, Power Port, Lower Interior Panels with Storage Compartments, and Cup			

Part Number	Factory Installed Options Description	SLP in US\$	Discount Percent
-------------	---------------------------------------	-------------	------------------

	<u>Controls</u>		
M__-R01-C03	<b>Advanced Control System (ACS)</b> Allows operator to select either hand or foot control of lift and tilt functions.	<b>\$1,504.00</b>	<b>30.0%</b>
M__-R01-C04	<b>Selectable Joystick Control (SJC)</b> Standard features include: Selectable patterns (ISO or H-Pattern), Horsepower Management, Speed Management, Drive Response and Foot Pedal for Engine Speed Control. <b>MUST ORDER</b> a Cab Opt Pkg	<b>\$2,395.00</b>	<b>30.0%</b>
	<b>*IF a Cab Option Pkg is not ordered, a Cab Accessories Pkg must be ordered with ACS</b>	<b>\$415.00</b>	<b>30.0%</b>

**Tire Options**

*(Set of 4 Tires in Place of Base Equipment)*

M__-R09-C03	<b>12-16.5, 12 Pr, Bobcat Heavy Duty Tires Offset</b> Loader width 68.5"	<b>\$85.00</b>	<b>30.0%</b>
M__-R09-C04	<b>12-16.5, 12 Pr, Bobcat Severe Duty Tires</b> Loader width 72.1"	<b>\$840.00</b>	<b>30.0%</b>
M__-R09-C05	<b>12-16.5, 12 Pr, Bobcat Severe Duty-Poly Fill Tires</b> Loader width 72.1"	<b>\$1,654.00</b>	<b>30.0%</b>
M__-R09-C11	<b>33 x 15.5-16.5, 12 PR, Bobcat Super Float Tires- Offset Rims</b> Loader width 72.1"	<b>\$882.00</b>	<b>30.0%</b>

**Other Factory Installed Options**

M__-R05-C11	<b>Air Ride Suspension Seat</b> Must order a Cab Option package.	<b>\$314.00</b>	<b>30.0%</b>
M__-R26-C02	<b>Radio</b> Must order a Cab Option package. Includes weatherproof AM/FM/NOAA Weather Band Radio, Speakers, and Antenna. Works with MP3 or other portable music player.	<b>\$417.00</b>	<b>30.0%</b>
M__-R03-C03	<b>High Flow Hydraulics</b> Provides 36.5 GPM and 3500 PSI for attachment operation. When ordering High Flow Hydraulics, the Bobcat Ordering systems will automatically add the 7 Pin Attachment Control Kit. Unless you are ordering an A71, H71 or O71 Cab Package that includes the Attachment Control Kit.	<b>\$1,883.00</b>	<b>30.0%</b>
M__-R28-C02	<b>Attachment 7 Pin Control Kit</b> Required when ordering High Flow Hydraulics. Kit is included in A91, A71, H71 & O71 Opt Pkgs	<b>\$205.00</b>	<b>30.0%</b>
M__-P03-F50	<b>High Flow Hydraulics, Two Speed, Hydraulic Bucket Positioning, Engine Block Heater</b>	<b>\$3,950.00</b>	<b>30.0%</b>
M__-R04-C02	<b>Two Speed</b> Includes 2-speed motors and Spring Applied/Pressure Release (SAPR) Brake. Low Travel Speed 7.1 MPH, High Travel Speed 12.3 MPH. When ordering 2 Speed option, the Bobcat Ordering systems will automatically add the Suspension seat with 3 point seat belt; Unless you are ordering a Cab Option Package which includes the suspension seat.	<b>\$1,582.00</b>	<b>30.0%</b>
M__-R05-C03	<b>Suspension Seat with Three Point Belt - Required if ordering a Two-Speed with No Cab Option Pkg</b>	<b>\$499.00</b>	<b>30.0%</b>
M__-P03-F20	<b>Two Speed, Engine Block Heater</b>	<b>\$1,654.00</b>	<b>30.0%</b>
M__-P03-F30	<b>Two Speed, Hydraulic Bucket Positioning, Engine Block Heater</b>	<b>\$2,111.00</b>	<b>30.0%</b>
M__-R11-C02	<b>Hydraulic Bucket Positioning</b>	<b>\$468.00</b>	<b>30.0%</b>

Bucket Positioning helps the operator to keep the same tilt of the load during lifting.

Includes On/Off switch.

M__-A01-C02	<b>Engine Block Heater</b>	<b>\$111.00</b>	<b>30.0%</b>
M__-P03-F10	<b>Hydraulic Bucket Positioning, Engine Block Heater</b>	<b>\$566.00</b>	<b>30.0%</b>

Part Number	Skid Steer Loader Description	SLP in US\$	Discount Percent
-------------	-------------------------------	-------------	------------------

M0291	<b>S850 Skid Steer Loader (equipped with Final Tier 4 engine)</b>	<b>\$65,714.00</b>	<b>30.0%</b>
-------	---	--------------------	--------------



Part Number	Air Conditioned/Heated Cab Packages Description	SLP in US\$	Discount Percent
-------------	---	-------------	------------------

M0191-P01-A91	<b>A91 Option Package</b>	<b>\$8,784.00</b>	<b>30.0%</b>
M0191-P01-A71	<b>A71 Option Package</b>	<b>\$6,349.00</b>	<b>30.0%</b>
M0191-P01-A51	<b>A51 Option Package</b>	<b>\$5,076.00</b>	<b>30.0%</b>
M0191-P01-A31	<b>A31 Option Package</b>	<b>\$4,425.00</b>	<b>30.0%</b>

<b><u>A31</u></b> Enclosed Cab with AC/Heat  Cab Accessories Package*	<b><u>A51</u></b> Enclosed Cab with AC/Heat  Cab Accessories Package* Power Bob-Tach	<b><u>A71</u></b> Enclosed Cab with AC/Heat  Cab Accessories Pkg* Power Bob-Tach Sound Reduction Deluxe Instrument Panel with Keyless Start  Attachment Control Kit	<b><u>A91</u></b> Enclosed Cab with AC/Heat  Cab Accessories Pkg* Power Bob-Tach Sound Reduction Deluxe Instrument Panel with Keyless Start  Attachment Control High Flow Hydraulics Hydraulic Bucket Positioning
--	--	--	---

Engine Block Heater

Part Number	Heated Cab Packages Description	SLP in US\$	Discount Percent
M0191-P01-H51	<b>H51 Option Package</b>	\$3,600.00	30.0%
	<u>H51</u> Enclosed Cab with Heat Cab Accessories Package* Power Bob-Tach		

Part Number	Open Cab Packages Description	SLP in US\$	Discount Percent
M0191-P01-O71	<b>O71 Option Package</b>	\$2,443.00	30.0%
M0191-P01-O51	<b>O51 Option Package</b>	\$1,484.00	30.0%
<u>O51</u> Cab Accessories Package* Deluxe Instrument Panel with Keyless Start	<u>O71</u> Cab Accessories Package* Deluxe Instrument Panel with Keyless Start Power Bob-Tach Attachment Control Kit		

*\*Cab Accessories Package : Deluxe Headliner with Dome Light, Cab Accessory Harness, Power Port, Lower Interior Panels with Storage Compartments, and Cup Holder.*

Part Number	Factory Installed Options Description	SLP in US\$	Discount Percent
-------------	---------------------------------------	-------------	------------------

**Controls**

M0191-R01-C04	<b>Selectable Joystick Control (SJC)</b> Standard features include: Selectable patterns (ISO or H-Pattern), Horsepower Management, Speed Management, Drive Response and Foot Pedal for Engine Speed Control. <b><u>MUST ORDER</u></b> a Cab Option Pkg	\$1,295.00	30.0%
---------------	---	------------	-------

Part Number	Factory Installed Options Description	SLP in US\$	Discount Percent
-------------	---------------------------------------	-------------	------------------

**Tire Options**

*(Set of 4 Tires in Place of Base Equipment)*

M0191-R09-C04	<b>14-17.5, 14 Pr, Bobcat Severe Duty Tires</b> Loader width 79"	\$1,353.00	30.0%
M0191-R09-C05	<b>14-17.5, 14 Pr, Bobcat Severe Duty-Poly Fill Tires</b> Loader width 79"	\$2,592.00	30.0%

**Factory Installed Options**

M0191-R05-C12	<b>Air Ride Suspension Seat</b>	\$314.00	30.0%
M0191-R26-C02	<b>Radio</b> Must order A Cab Option Package. Includes weatherproof AM/FM/NOAA Weather Band Radio, Speakers, and Antenna. Works with MP3 or other portable music player.	\$417.00	30.0%
M0191-R03-C03	<b>High Flow Hydraulics</b> Provides 37 GPM and 3500 PSI for attachment operation. The Bobcat Ordering systems will automatically add the 7 Pin Attachment Control Kit if the High Flow Hydraulics are ordered; Unless you are ordering an A71 or O71 Cab Option Package that includes the Attachment Control Kit	\$1,883.00	30.0%
M0191-R28-C02	<b>Attachment 7 Pin Control Kit</b> Required when ordering High Flow Hydraulics. Kit is included in A91, A71, H71 & O71 Opt Pkgs	\$205.00	30.0%
M0191-R11-C02	<b>Hydraulic Bucket Positioning</b> Bucket Positioning helps the operator to keep the same tilt of the load during lifting. Includes On/Off switch	\$468.00	30.0%
M0191-A01-C02	<b>Engine Block Heater</b>	\$111.00	30.0%
M0191-P03-F10	<b>Hydraulic Bucket Positioning, Engine Block Heater</b>	\$566.00	30.0%

**Price**

**\$14,226.10**

**Price**

**\$1,225.00**

**\$154.00**

**\$129.50**

**\$129.50**

**Price**

**\$23,159.50**

**Price**



**\$3,379.60**

**Price**

**\$2,375.10**

**Price**

**\$557.90**

**Price**

**\$980.70**

**\$1,862.00**

**\$276.50**

**\$66.50**

**Price**

**\$23,718.10**

**\$24,804.50**

**Price**

**\$2,375.10**

**Price**

**\$1,613.50**

**\$977.90**

**\$557.90**

**Price**

**\$980.70**

**\$1,536.50**

**\$290.50**

**\$143.50**

**\$1,218.70**

**\$1,537.90**

**\$327.60**

**\$349.30**

**\$140.00**

**\$219.80**

**\$291.90**

**\$172.90**

**\$202.30**

**\$650.30**

**\$1,080.80**

**\$407.40**

**Price**

**\$25,986.10**

**\$27,434.40**

**\$28,363.30**

**Price**

**\$6,851.60**

**\$4,315.50**

**\$3,451.00**

**\$3,006.50**

**Price**

**\$2,446.50**

**Price**

**\$1,661.10**

**\$1,008.00**

**\$575.40**

**Price**



**\$980.70**

**\$1,536.50**

**\$290.50**

**\$219.80**

**\$291.90**

**\$1,099.70**

**\$143.50**

**\$2,612.40**

**\$1,107.40**

**\$349.30**

**\$1,218.70**

**\$1,537.90**

**\$327.60**

**\$140.00**

**\$457.10**

**\$172.90**

**\$202.30**

**\$650.30**

**\$1,080.80**

**\$407.40**

**\$0.00**

**\$37.10**

**\$481.60**

**\$911.40**

**Price**

**\$30,153.20**

**\$31,821.30**

**Price**

**\$7,095.90**

**\$4,444.30**

**\$3,553.20**

**\$3,097.50**



**Price**

**\$2,520.00**

**Price**

**\$1,710.10**

**\$1,038.80**

**\$593.60**

<b>Price</b>
--------------

**\$1,052.80**

**\$1,676.50**

**\$290.50**

**\$59.50**

**\$588.00**

**\$1,157.80**

**\$617.40**

**\$219.80**

**\$291.90**

**\$1,318.10**

**\$143.50**

**\$2,765.00**

**\$1,107.40**

**\$349.30**

**\$1,477.70**

**\$1,157.80**

**\$327.60**

**\$77.70**

**\$396.20**

**Price**

**\$34,993.00**

**Price**

**\$7,095.90**

**\$4,444.30**

**\$3,553.20**

**\$3,097.50**

**Price**

**\$2,520.00**

**Price**

**\$1,710.10**

**\$1,038.80**

**\$593.60**

**Price**

**\$1,052.80**

**\$1,676.50**

**\$290.50**

**\$59.50**

**\$588.00**

**\$1,157.80**

**\$617.40**

**\$219.80**

**\$291.90**

**\$1,318.10**

**\$143.50**

**\$2,765.00**

**\$1,107.40**

**\$349.30**

**\$1,157.80**

**\$1,477.70**

**\$327.60**

**\$77.70**

**\$396.20**

**Price**

**\$38,730.30**

**\$39,867.10**

**Price**

**\$7,095.90**

**\$4,444.30**

**\$3,553.20**

**\$3,097.50**

**Price**

**\$2,520.00**

**Price**

**\$1,710.10**

**\$1,038.80**

**\$593.60**

**Price**

**\$1,052.80**

**\$1,676.50**

**\$290.50**



**\$59.50**

**\$588.00**

**\$1,157.80**

**\$617.40**

**\$219.80**

**\$291.90**

**\$1,318.10**

**\$143.50**

**\$2,765.00**

**\$1,107.40**

**\$349.30**

**\$1,157.80**

**\$1,477.70**

**\$327.60**

\$77.70  
\$396.20

Price

\$45,999.80

Price

\$6,148.80  
\$4,444.30  
\$3,553.20  
\$3,097.50

**Price**

**\$2,520.00**

**Price**

**\$1,710.10**

**\$1,038.80**

**Price**

**\$906.50**

**Price**

**\$947.10**

**\$1,814.40**

**\$219.80**

**\$291.90**

**\$1,318.10**

**\$143.50**

**\$327.60**

**\$77.70**

**\$396.20**



Part Number	Compact Track Loader Description	SLP in US\$	Discount Percent
M0207	T450 Compact Track Loader (equipped with Tier 4 Engine)	\$45,128.00	30.0%



Part Number	Air Conditioned/Heated Cab Packages Description	SLP in US\$	Discount Percent
M__-P01-A81	A81 Option Package	\$7,706.00	30.0%
-	<p style="text-align: center;"><u>A81</u>                      Enclosed Cab with AC/Heat                      Two Speed                      Cab Accessories Package*                      Power Bob-Tach                      Sound Reduction                      Deluxe Instrument Panel with Keyless Start                      Attachment Control Kit                      3-Point Seat Belt</p>		

Part Number	Open Cab Packages Description	SLP in US\$	Discount Percent
M__-P01-O71	O71 Option Package	\$2,055.00	30.0%
	<p style="text-align: center;"><u>O71</u>                      Cab Accessories Package*                      Power Bob-Tach                      Deluxe Instrument Panel with Keyless Start                      Attachment Control Kit</p>		

*\*Cab Accessories Pkg Incls : Deluxe Headliner with Dome Light, Cab Accessory Harness, Power Port, Lower Interior Panels with Storage Compartments, and Cup Holder.*

Part Number	Factory Installed Options Description	SLP in US\$	Discount Percent
	<b><u>Controls</u></b>		
M__-R01-C03	<b>Advanced Control System (ACS)*</b> Allows operator to select either hand or foot control of lift and tilt functions.	<b>\$1,401.00</b>	<b>30.0%</b>
M__-R01-C04	<b>Selectable Joystick Control (SJC)*</b> Standard features include: Selectable patterns (ISO or H-Pattern), Horsepower Management, Speed Management, Drive Response and Foot Pedal for Engine Speed Control.	<b>\$2,555.00</b>	<b>30.0%</b>
M__-R80-C02	<b>*IF a Cab Option Pkg is not ordered, a Cab Accessories Pkg must be ordered with ACS or SJC</b>	<b>\$415.00</b>	<b>30.0%</b>
	<b><u>Other Options</u></b>		
M__-R04-C02	<b>Two Speed</b> Incls 2-speed motor and 3-point seat belt. Low Travel Speed 7.3 MPH, High Travel Speed 11.0 MPH	<b>\$1,859.00</b>	<b>30.0%</b>

Part Number	Compact Track Loader Description	SLP in US\$	Discount Percent
M0255	T550 Compact Track Loader (equipped with Final Tier 4 Engine)	\$49,276.00	30.0%
M0263	T590 Compact Track Loader (equipped with Final Tier 4 engine)	\$52,952.00	30.0%



Part Number	Air Conditioned/Heated Cab Packages Description	SLP in US\$	Discount Percent
M_-P01-A91	A91 Option Package	\$7,988.00	30.0%
M_-P01-A71	A71 Option Package	\$5,847.00	30.0%
M_-P01-A51	A51 Option Package	\$4,612.00	30.0%
M_-P01-A31	A31 Option Package	\$3,976.00	30.0%

**A31**  
Enclosed Cab with AC/Heat

**A51**  
Enclosed Cab with AC/Heat

**A71**  
Enclosed Cab with AC/Heat

**A91**  
Enclosed Cab with AC/Heat

Cab Accessories Package\*

Cab Accessories Package\*  
Power Bob-Tach

Cab Accessories Package\*  
Power Bob-Tach  
Sound Reduction  
Deluxe Instrument Panel w/Keyless Start  
Attachment Control Kit

Cab Accessories Pkg\*  
Power Bob-Tach  
Sound Reduction  
Deluxe Instrument Panel w/Keyless Start  
Attachment Control  
High Flow Hydraulics  
Hydraulic Bucket Positioning  
Cold Weather Pkg

Part Number	Heated Cab Packages Description	SLP in US\$	Discount Percent
-------------	---------------------------------	-------------	------------------

M__-P01-H51	<b>H51 Option Package</b>	<b>\$3,177.00</b>	<b>30.0%</b>
-------------	---------------------------	-------------------	--------------

**H51**

Enclosed Cab with Heat  
 Suspension Seat  
 Cab Accessories Package\*  
 Power Bob-Tach

Part Number	Open Cab Packages Description	SLP in US\$	Discount Percent
-------------	-------------------------------	-------------	------------------

M__-P01-O71	<b>O71 Option Package</b>	<b>\$2,055.00</b>	<b>30.0%</b>
M__-P01-O51	<b>O51 Option Package</b>	<b>\$1,122.00</b>	<b>30.0%</b>

**O51**

Suspension Seat  
 Cab Accessories Package\*  
 Deluxe Instrument Panel with Keyless Start

**O71**

Suspension Seat  
 Cab Accessories Package\*  
 Deluxe Instrument Panel with  
 Keyless Start  
 Power Bob-Tach  
 Attachment Control Kit

*\*Cab Accessories Package : Deluxe Headliner with Dome Light, Cab Accessory Harness, Power Port, Lower Interior Panels with Storage Compartments, and Cup*

Part Number	Factory Installed Options Description	SLP in US\$	Discount Percent
-------------	---------------------------------------	-------------	------------------

**Controls**

M__-R01-C03	<b>Advanced Control System (ACS)</b>	<b>\$1,401.00</b>	<b>30.0%</b>
-------------	--------------------------------------	-------------------	--------------

Allows operator to select either hand or foot control of lift and tilt functions.

M__-R01-C04	<b>Selectable Joystick Control (SJC)</b>	<b>\$2,555.00</b>	<b>30.0%</b>
-------------	--	-------------------	--------------

Standard features include: Selectable patterns (ISO or H-Pattern), Horsepower Management, Speed Management, Drive Response and Foot Pedal for Engine Speed Control.

M__-R80-C02	<b>*IF a Cab Option Pkg is not ordered, a Cab Accessories Pkg must be ordered with ACS or SJC</b>	<b>\$415.00</b>	<b>30.0%</b>
-------------	---	-----------------	--------------

**Other Factory Installed Options**



M__-R05-C11	<b>Air Ride Suspension Seat</b> Must order a Cab Option package.	<b>\$314.00</b>	<b>30.0%</b>
M__-R26-C02	<b>Radio</b> Must order a Cab Option package. Includes weatherproof AM/FM/NOAA Weather Band Radio, Speakers, and Antenna. Works with MP3 or other portable music player.	<b>\$417.00</b>	<b>30.0%</b>
M__-R03-C03	<b>High Flow Hydraulics</b> Provides 26.7 GPM and 3500 PSI for attachment operation. The 7 pin attachment control kit is required.	<b>\$1,571.00</b>	<b>30.0%</b>
M__-R28-C02	<b>7 Pin Attachment Control Kit</b> Required when ordering High Flow Hydraulics. Kit is included in A91, A71 & O71 Opt Pkgs	<b>\$205.00</b>	<b>30.0%</b>
M__-R11-C02	<b>Hydraulic Bucket Positioning</b> Bucket Positioning helps the operator to keep the same tilt of the load during lifting. Includes On/Off switch.	<b>\$468.00</b>	<b>30.0%</b>
M__-P03-F10	<b>Hydraulic Bucket Positioning, Cold Weather Package</b>	<b>\$653.00</b>	<b>30.0%</b>
M__-A01-C02	<b>Cold Weather Package</b> (Incs Eng Block Heater and Larger Battery (950 cca))	<b>\$200.00</b>	<b>30.0%</b>
<b><u>Track Options</u></b>			
M__-R09-C02	<b>16" Rubber Track, with Solid Mount Carriage</b> Includes Solid Mounted Undercarriage with 4 Solid Mounted Rollers	<b>\$1,437.00</b>	<b>30.0%</b>
M__-R09-C03	<b>12" Rubber Track with Roller Suspension Carriage</b> Includes Solid Mounted undercarriage and 3 Rollers with Leaf Spring style suspension.	<b>\$1,558.00</b>	<b>30.0%</b>
M__-R09-C04	<b>16" Rubber Track with Roller Suspension Carriage</b> Includes Solid Mounted undercarriage and 3 Rollers with Leaf Spring style suspension.	<b>\$2,995.00</b>	<b>30.0%</b>

Part Number	Compact Track Loader Description	SLP in US\$	Discount Percent
M0267	<b>T630 Compact Track Loader (equipped with Final Tier 4 engine)</b>	\$54,856.00	30.0%
M0271	<b>T650 Compact Track loader (equipped with Final Tier 4 engine)</b>	\$58,560.00	30.0%



Part Number	Air Conditioned/Heated Cab Packages Description	SLP in US\$	Discount Percent
M__-P01-A91	<b>A91 Option Package</b>	\$10,137.00	30.0%
M__-P01-A71	<b>A71 Option Package</b>	\$6,030.00	30.0%
M__-P01-A51	<b>A51 Option Package</b>	\$4,757.00	30.0%
M__-P01-A31	<b>A31 Option Package</b>	\$4,106.00	30.0%

**A31**  
Enclosed Cab with AC/Heat  
Cab Accessories Package\*

**A71**  
Enclosed Cab with AC/Heat  
Cab Accessories Package\*  
Power Bob-Tach  
Sound Reduction  
Deluxe Instrument Panel with Keyless Start

**A51**  
Enclosed Cab with AC/Heat  
Cab Accessories Package\*  
Power Bob-Tach

Attachment Control Kit

**A91**  
Enclosed Cab with AC/Heat  
Cab Accessories Package\*  
Power Bob-Tach  
Sound Reduction  
Deluxe Instrument Panel with Keyless Start  
Attachment Control Kit  
High Flow Hydraulics  
Hydraulic Bucket Positioning  
Two Speed, 3 pt Seat Belt  
Engine Block Heater

Part Number	Heated Cab Packages Description	SLP in US\$	Discount Percent
M__-P01-H51	<b>H51 Option Package</b>	\$3,282.00	30.0%

**H51**

Enclosed Cab with Heat  
Cab Accessories Package\*  
Power Bob-Tach

Part Number	Open Cab Packages Description	SLP in US\$	Discount Percent
-------------	-------------------------------	-------------	------------------

M__-P01-O71	<b>O71 Option Package</b>	<b>\$2,125.00</b>	<b>30.0%</b>
M__-P01-O51	<b>O51 Option Package</b>	<b>\$1,166.00</b>	<b>30.0%</b>

**O51**

Cab Accessories Package\*  
Deluxe Instrument Panel with  
Keyless Start

**O71**

Cab Accessories Package\*  
Deluxe Instrument Panel with Keyless Start  
Power Bob-Tach  
Attachment Control Kit

*\*Cab Accessories Package: Deluxe Headliner with Dome Light, Rear Cab Corner Trim, Cab Accessory Harness, Power Port, Lower Interior Panels with Storage Compartments and Cup Holder.*

Part Number	Factory Installed Options Description	SLP in US\$	Discount Percent
-------------	---------------------------------------	-------------	------------------

<b><u>Controls</u></b>			
M__-R01-C03	<b>Advanced Control System (ACS)</b> Allows operator to select either hand or foot control of lift and tilt functions.	<b>1,504.00</b>	<b>30.0%</b>
M__-R01-C04	<b>Selectable Joystick Control (SJC)</b> Standard features include: Selectable patterns (ISO or H-Pattern), Horsepower Management, Speed Management, Drive Response and Foot Pedal for Engine Speed Control.	<b>2,750.00</b>	<b>30.0%</b>
M__-R80-C02	<b>*IF a Cab Option Pkg is not ordered, a Cab Accessories Pkg must be ordered with ACS or SJC</b>	<b>\$395.00</b>	<b>30.0%</b>

<b><u>Track Options</u></b>			
M__-R09-C02	<b>17.7" Rubber Tracks</b> Compatible with Solid Mounted or Roller Suspension Carriages - Width 78.0"	<b>\$1,494.00</b>	<b>30.0%</b>
M__-R21-C02	<b>Roller Suspension Carriage</b> Includes Solid Mounted undercarriage and 4 Rollers with Leaf Spring style suspension. Compatible with 18" tracks. - Width 78"	<b>\$1,638.00</b>	<b>30.0%</b>

**Individual Options**

M__-R05-C11	<b>Air Ride Suspension Seat</b>	<b>\$314.00</b>	<b>30.0%</b>
M__-R26-C02	<b>Radio</b> Must order a Cab Option package. Includes weatherproof AM/FM/NOAA Weather Band Radio, Speakers, and Antenna. Works with MP3 or other portable music player.	<b>\$417.00</b>	<b>30.0%</b>
<b><u>Other Factory Installed Options</u></b>			
M__-R03-C03	<b>High Flow Hydraulics</b> Provides 30.5 GPM and 3500 PSI for attachment operation. The Bobcat Ordering systems will automatically add the 7 Pin Attachment Control Kit if the High Flow Hydraulics are ordered. Unless you are ordering a Cab Option Package that includes the Attachment Control Kit	<b>\$1,883.00</b>	<b>30.0%</b>
M__-R28-C02	<b>Attachment 7 Pin Control Kit</b> Required when ordering High Flow Hydraulics. Kit is included in A91, A71, H71 & O71 Opt Pkgs	<b>\$205.00</b>	<b>30.0%</b>
M__-P03-F50	<b>High Flow Hydraulics, Two Speed, Hydraulic Bucket Positioning, Engine Block Heater</b>	<b>\$4,367.00</b>	<b>30.0%</b>
M__-RO4-C02	<b>Two Speed</b> Two Speed Option includes 3-Point Seat Belt	<b>\$2,010.00</b>	<b>30.0%</b>
M__-P03-F30	<b>Two Speed, Hydraulic Bucket Positioning, Engine Block Heater</b>	<b>\$2,529.00</b>	<b>30.0%</b>
M__-P03-F20	<b>Two Speed, Engine Block Heater</b>	<b>\$2,072.00</b>	<b>30.0%</b>
M__-R11-C02	<b>Hydraulic Bucket Positioning</b> Bucket positioning helps the operator to keep the same tilt of the load during lifting. Includes On/Off switch	<b>\$468.00</b>	<b>30.0%</b>
M__-A01-C02	<b>Engine Block Heater</b>	<b>\$111.00</b>	<b>30.0%</b>
M__-P03-F10	<b>Hydraulic Bucket Positioning, Engine Block Heater</b>	<b>\$566.00</b>	<b>30.0%</b>

Part Number	Compact Track Loader Description	SLP in US\$	Discount Percent
M0281	<b>T750 Compact Track Loader (equipped with Final Tier 4 engine)</b>	\$71,091.00	30.0%
M0285	<b>T770 Compact Track Loader (equipped with Final Tier 4 engine)</b>	\$74,337.00	30.0%



Part Number	Air Conditioned/Heated Cab Packages Description	SLP in US\$	Discount Percent
M__-P01-A91	A91 Option Package	\$10,137.00	30.0%
M__-P01-A71	A71 Option Package	\$6,030.00	30.0%
M__-P01-A51	A51 Option Package	\$4,757.00	30.0%
M__-P01-A31	A31 Option Package	\$4,106.00	30.0%

**A31**

Enclosed Cab with AC/Heat  
Cab Accessories Package\*

**A71**

Enclosed Cab with AC/Heat  
Cab Accessories Package\*  
Power Bob-Tach

**A91**

Enclosed Cab with AC/Heat  
Cab Accessories Package\*  
Power Bob-Tach

**A51**

Enclosed Cab with AC/Heat  
Cab Accessories Package\*  
Power Bob-Tach

**Sound Reduction**

Deluxe Instrument Panel with Keyless Start  
Attachment Control Kit

**Sound Reduction**

Deluxe Instrument Panel with Keyless Start  
Attachment Control Kit  
High Flow Hydraulics  
Two Speed with 3 Point Belt  
Hydraulic Bucket Positioning  
Engine Block Heater

Part Number	Heated Cab Packages Description	SLP in US\$	Discount Percent
-------------	---------------------------------	-------------	------------------

M__-P01-H51	H51 Option Package	\$3,282.00	30.0%
-------------	--------------------	------------	-------

**H51**

Enclosed Cab with Heat  
Cab Accessories Package\*  
Power Bob-Tach

Part Number	Open Cab Packages Description	SLP in US\$	Discount Percent
-------------	-------------------------------	-------------	------------------

M__-P01-O71	O71 Option Package	\$2,125.00	30.0%
M__-P01-O51	O51 Option Package	\$1,166.00	30.0%

**O51**

**O71**

Cab Accessories Package\*  
 Deluxe Instrument Panel with  
 Keyless Start

Cab Accessories Package\*  
 Deluxe Instrument Panel with Keyless Start  
 Power Bob-Tach  
 Attachment Control Kit

*\*Cab Accessories Package: Deluxe Headliner with Dome Light, Cab Accessory Harness, Power Port, Lower Interior Panels with Storage Compartments and Cup Holder.*

Part Number	Factory Installed Options Description	SLP in US\$	Discount Percent
<b><u>Controls</u></b>			
M__-R01-C03	<b>Advanced Control System (ACS)*</b> Allows operator to select either hand or foot control of lift and tilt functions.	<b>\$1,504.00</b>	<b>30.0%</b>
M__-R01-C04	<b>Selectable Joystick Control (SJC)*</b> Standard features include: Selectable patterns (ISO or H-Pattern), Horsepower Management, Speed Management, Drive Response and Foot Pedal for Engine Speed Control.	<b>\$2,750.00</b>	<b>30.0%</b>
M__-R80-C02	<b>*IF a Cab Option Pkg is not ordered, a Cab Accessories Pkg must be ordered with ACS or SJC</b>	<b>\$415.00</b>	<b>30.0%</b>
<b><u>Track Options</u></b>			
M__-R21-C02	<b>Roller Suspension Carriage</b> Includes Solid Mounted undercarriage and 4 Rollers with Leaf Spring style suspension. Compatible with 12.6" Tracks (Machine Width 73.4") or 17.7" Tracks. (Machine Width 78.0")	<b>\$1,638.00</b>	<b>30.0%</b>
<b><u>Other Factory Installed Options</u></b>			
M__-R05-C11	<b>Air Ride Suspension Seat</b> Must order a Cab Option Package.	<b>\$314.00</b>	<b>30.0%</b>
M__-R26-C02	<b>Radio</b> Must order a Cab Option Package. Includes weatherproof AM/FM/NOAA Weather Band Radio, Speakers, and Antenna. Works with MP3 or other portable music player.	<b>\$417.00</b>	<b>30.0%</b>
M__-R03-C03	<b>High Flow Hydraulics</b> Provides 36.5 GPM and 3500 PSI for attachment operation. When ordering High Flow Hydraulics, the Bobcat Ordering systems will automatically add the 7 Pin Attachment Control Kit. Unless you are ordering an A71 or O71 Cab Package that includes the Attachment Control Kit	<b>\$1,883.00</b>	<b>30.0%</b>
M__-R28-C02	<b>Attachment 7 Pin Control Kit</b> Required when ordering High Flow Hydraulics. Kit is included in A91, A71, H71 & O71 Opt Pkgs	<b>\$205.00</b>	<b>30.0%</b>
M__-P03-F50	<b>High Flow Hydraulics, Two Speed, Hydraulic Bucket</b>	<b>\$4,367.00</b>	<b>30.0%</b>

<b>M__-R04-C02</b>	<b>Positioning, Engine Block Heater Two Speed</b>	<b>\$2,010.00</b>	<b>30.0%</b>
	Includes 2-speed motors, Spring Applied/Pressure Release (SAPR) Brake and 3 point Seat Belt. Low Travel Speed 6.1 MPH, High Travel Speed 10.7 MPH		
<b>M__-P03-F30</b>	<b>Two Speed, Hydraulic Bucket Positioning, Engine Block Heater</b>	<b>\$2,529.00</b>	<b>30.0%</b>
<b>M__-P03-F20</b>	<b>Two Speed, Engine Block Heater</b>	<b>\$2,072.00</b>	<b>30.0%</b>
<b>M__-R11-C02</b>	<b>Hydraulic Bucket Positioning</b>	<b>\$468.00</b>	<b>30.0%</b>
	Bucket Positioning helps the operator to keep the same tilt of the load during lifting. Includes On/Off switch		
<b>M__-A01-C02</b>	<b>Engine Block Heater</b>	<b>\$111.00</b>	<b>30.0%</b>
<b>M__-P03-F10</b>	<b>Hydraulic Bucket Positioning, Engine Block Heater</b>	<b>\$566.00</b>	<b>30.0%</b>

<b>Part Number</b>	<b>Compact Track Loader Description</b>	<b>SLP in US\$</b>	<b>Discount Percent</b>
<b>M0195</b>	<b>T870 Compact Track Loader (equipped with Final Tier 4 engine)</b>	<b>\$82,204.00</b>	<b>30.0%</b>



<b>Part Number</b>	<b>Air Conditioned/Heated Cab Packages Description</b>	<b>SLP in US\$</b>	<b>Discount Percent</b>
<b>M0195-P01-A91</b>	<b>A91 Option Package</b>	<b>\$8,465.00</b>	<b>30.0%</b>
<b>M0195-P01-A71</b>	<b>A71 Option Package</b>	<b>\$6,349.00</b>	<b>30.0%</b>
<b>M0195-P01-A51</b>	<b>A51 Option Package</b>	<b>\$5,076.00</b>	<b>30.0%</b>
<b>M0195-P01-A31</b>	<b>A31 Option Package</b>	<b>\$4,425.00</b>	<b>30.0%</b>

**A31**  
Enclosed Cab with AC/Heat  
Cab Accessories Package\*

**A71**  
Enclosed Cab with AC/Heat  
Cab Accessories Package\*  
Power Bob-Tach

Sound Reduction  
Deluxe Instrument Panel with Keyless Start

Attachment Control Kit

**A51**  
Enclosed Cab with AC/Heat  
Cab Accessories Package\*  
Power Bob-Tach

**A91**  
Enclosed Cab with AC/Heat  
Cab Accessories Package\*  
Power Bob-Tach  
Sound Reduction  
Deluxe Instrument Panel with Keyless Start  
Attachment Control Kit  
High Flow Hydraulics

Two Speed with 3 Point Belt  
 Hydraulic Bucket Positioning  
 Engine Block Heater

Part Number	Open Cab Packages Description	SLP in US\$	Discount Percent
M0195-P01-O71	<b>O71 Option Package</b>	<b>\$2,443.00</b>	<b>30.0%</b>
M0195-P01-O51	<b>O51 Option Package</b>	<b>\$1,484.00</b>	<b>30.0%</b>

<u>O51</u>	<u>O71</u>
Cab Accessories Package*	Cab Accessories Package*
Deluxe Instrument Panel with Keyless Start	Deluxe Instrument Panel with Keyless Start
	Power Bob-Tach
	Attachment Control Kit
	<i>*Cab Accessories Package: Deluxe Headliner with Dome Light, Cab Accessory Harness, Power Port, Lower Interior Panels with Storage Compartments, and Cup Holder.</i>

Part Number	Factory Installed Options Description	SLP in US\$	Discount Percent
<u>Controls</u>			
M0195-R01-C04	<b>Selectable Joystick Control (SJC)</b> Standard features include: Selectable patterns (ISO or H-Pattern), Horsepower Management, Speed Management, Drive Response and Foot Pedal for Engine Speed Control.	<b>\$1,295.00</b>	<b>30.0%</b>

Part Number	Factory Installed Options Description	SLP in US\$	Discount Percent
M0195-R05-C11	<b>Air Ride Suspension Seat</b> Must order an A, H or O Cab Package.	<b>\$314.00</b>	<b>30.0%</b>
M0195-R26-C02	<b>Radio</b> Must order an A, H or O Cab Package. Includes weatherproof AM/FM/NOAA Weather Band Radio, Speakers, and Antenna. Works with MP3 or other portable music player.	<b>\$417.00</b>	<b>30.0%</b>
M0195-R03-C03	<b>High Flow Hydraulics</b> Provides 37.4 GPM and 3500 PSI for attachment operation. When ordering High Flow Hydraulics, the Bobcat Ordering systems will automatically add a 7 Pin Attachment Control Kit. Unless you are ordering an A71 or O71 Cab Package that includes the Attachment Control Kit	<b>\$1,883.00</b>	<b>30.0%</b>
M0195-R28-C02	<b>Attachment 7 Pin Control Kit</b> Required when ordering High Flow Hydraulics. Kit is included in A91, A71, O71 Opt Pkgs	<b>\$205.00</b>	<b>30.0%</b>



<b>M0195-R11-C02</b>	<b>Hydraulic Bucket Positioning</b> Bucket Positioning helps the operator to keep the same tilt of the load during lifting. Includes On/Off switch	<b>\$468.00</b>	<b>30.0%</b>
<b>M0195-A01-C02</b>	<b>Engine Block Heater</b>	<b>\$111.00</b>	<b>30.0%</b>
<b>M0195-P03-F10</b>	<b>Hydraulic Bucket Positioning, Engine Block Heater</b>	<b>\$566.00</b>	<b>30.0%</b>

**Price**

**\$31,589.60**

**Price**

**\$5,394.20**

**Price**

**\$1,438.50**

Price
-------

**\$980.70**

**\$1,788.50**

**\$290.50**

**\$1,301.30**

**Price**

**\$34,493.20**

**\$37,066.40**

**Price**

**\$5,591.60**

**\$4,092.90**

**\$3,228.40**

**\$2,783.20**

**Price**

**\$2,223.90**

**Price**

**\$1,438.50**  
**\$785.40**

**Price**

**\$980.70**

**\$1,788.50**

**\$290.50**

**\$219.80**

**\$291.90**

**\$1,099.70**

**\$143.50**

**\$327.60**

**\$457.10**

**\$140.00**

**\$1,005.90**

**\$1,090.60**

**\$2,096.50**

**Price**

**\$38,399.20**

**\$40,992.00**

**Price**

**\$7,095.90**

**\$4,221.00**

**\$3,329.90**

**\$2,874.20**

**Price**

**\$2,297.40**

**Price**

**\$1,487.50**

**\$816.20**

**Price**

**\$1,052.80**

**\$1,925.00**

**\$276.50**

**\$1,045.80**

**\$1,146.60**



**\$219.80**  
**\$291.90**

**\$1,318.10**

**\$143.50**

**\$3,056.90**

**\$1,407.00**

**\$1,770.30**

**\$1,450.40**

**\$327.60**

**\$77.70**

**\$396.20**

**Price**

**\$49,763.70**

**\$52,035.90**

**Price**

**\$7,095.90**

**\$4,221.00**

**\$3,329.90**

**\$2,874.20**

**Price**

**\$2,297.40**

**Price**

**\$1,487.50**

**\$816.20**

Price
-------

**\$1,052.80**

**\$1,925.00**

**\$290.50**

**\$1,146.60**

**\$219.80**

**\$291.90**

**\$1,318.10**

**\$143.50**

**\$3,056.90**

**\$1,407.00**

**\$1,770.30**

**\$1,450.40**

**\$327.60**

**\$77.70**

**\$396.20**

**Price**

**\$57,542.80**

**Price**

**\$5,925.50**

**\$4,444.30**

**\$3,553.20**

**\$3,097.50**

**Price**

**\$1,710.10**

**\$1,038.80**

**Price**

**\$906.50**

**Price**

**\$219.80**

**\$291.90**

**\$1,318.10**

**\$143.50**

**\$327.60**

**\$77.70**

**\$396.20**

April 1, 2015  
BOBCAT SLP Pages



Part Number	All Wheel Steer Loader Description	SLP in US\$	Discount Percent	Price
M0187	A770 All Wheel Steer Loader (equipped with Final T4 engine)	\$65,214.00	30.0%	\$45,649.80



Part Number	Air Conditioned/Heated Cab Packages Description	SLP in US\$	Discount Percent	Price
M0187-P01-A91	A91 Option Package	\$8,465.00	30.0%	\$5,925.50
M0187-P01-A71	A71 Option Package	\$6,030.00	30.0%	\$4,221.00
M0187-P01-A51	A51 Option Package	\$4,757.00	30.0%	\$3,329.90

**A51**

Enclosed Cab with AC/Heat  
Cab Accessories Package\*  
Power Bob-Tach

**A71**

Enclosed Cab with AC/Heat  
Cab Accessories Package\*  
Power Bob-Tach  
Sound Reduction  
Deluxe Instrument Panel with Keyless Start  
Attachment Control Kit

**A91**

Enclosed Cab with AC/Heat  
Cab Accessories Package\*  
Power Bob-Tach  
Sound Reduction  
Deluxe Instrument Panel with Keyless Start  
Attachment Control Kit  
High Flow Hydraulics  
Hydraulic Bucket Positioning  
Engine Block Heater

Part Number	Open Cab Packages Description	SLP in US\$	Discount Percent	Price
M0187-P01-O71	<b>O71 Option Package</b>	\$2,125.00	30.0%	\$1,487.50
	<u><b>O71</b></u> Cab Accessories Package* Deluxe Instrument Panel with Keyless Start Power Bob-Tach Attachment Control Kit			
	<i>Cab Accessories Package: Deluxe Headliner with Dome Light, Cab Accessory Harness, Power Port, Lower Interior Panels with Storage Compartments and Cup Holder.</i>			

Part Number	Factory Installed Options Description	SLP in US\$	Discount Percent	Price
	<u><b>Tire Options</b></u> (Set of 4 Tires in Place of Base Equipment)			
M0187-R09-C04	<b>12-16.5, 12 Pr, Bobcat Severe Duty Tires</b> Loader width 72.1"	\$840.00	30.0%	\$588.00
M0187-R09-C05	<b>12-16.5, 12 Pr, Bobcat Severe Duty-Poly Fill Tires</b> Loader width 72.1"	\$1,654.00	30.0%	\$1,157.80
M0187-R09-C06	<b>33 x 15.5-16.5, 12 PR, Bobcat Super Float Tires- Offset Rims</b> Loader width 80"	\$882.00	30.0%	\$617.40
M0187-R09-C12	<b>33 x 15.5-16.5, 12 PR, Turf and Sand Tires</b> Loader width 80"	\$929.00	30.0%	\$650.30

Part Number	Factory Installed Options Description	SLP in US\$	Discount Percent	Price
M0187-R05-C12	<b>Air Ride Suspension Seat</b> Must order a Cab Option Package	\$314.00	30.0%	\$219.80
M0187-R26-C12	<b>Radio</b> Must order a Cab Option Package Includes weatherproof AM/FM/NOAA Weather Band Radio, Speakers, and Antenna. Works with MP3 or other portable music player.	\$417.00	30.0%	\$291.90
M0187-R03-C03	<b>High Flow Hydraulics</b> Provides 36.5 GPM and 3500 PSI for attachment operation. The Bobcat Ordering systems will automatically add the 7 Pin Attachment Control Kit if the High Flow Hydraulics are ordered. Unless you are ordering an A71, H71 or O71 Cab Package that includes the Attachment Control Kit	\$1,883.00	30.0%	\$1,318.10
M0187-P01-F20	<b>Attachment 7 Pin Control Kit</b>	\$205.00	30.0%	\$143.50



Required when ordering High Flow Hydraulics.  
Kit is included in A91, A71, H71 & O71 Opt Pkgs

**Hydraulic Bucket Positioning**

Bucket Positioning helps the operator to keep the same tilt of the load during lifting.  
Includes On/Off switch

**Engine Block Heater**

**Hydraulic Bucket Positioning, Engine Block Heater**

**M0187-R11-C02**

**\$468.00**

**30.0%**

**\$327.60**

**M0187-A01-C02**

**\$111.00**

**30.0%**

**\$77.70**

**M0187-P03-F10**

**\$566.00**

**30.0%**

**\$396.20**



Part Number	Angle Brooms Description	SLP in US\$	Discount Percent	Labor	Price
-------------	--------------------------	-------------	------------------	-------	-------

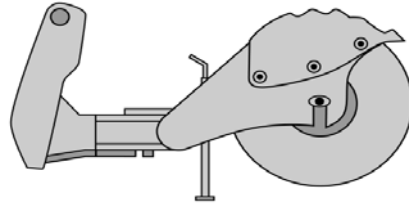

(S70) 6907000	<b>48" Angle Broom</b> (Manual Angle, 3-Positions: 30° Right, Left and Straight)	\$3,190.00	24.0%	\$0.00	\$2,424.40
------------------	---	------------	-------	--------	------------

(S450 S510, S550, S530, S570, S590) (S630, S650, S740, S750, S770) (T450, T550, T590) (A770) (T630, T650, T750, T770) 6905805	<b>68" Angle Broom</b> (Loader must be equipped with an Attachment Control Kit) (When used on loaders equipped with a 14-Pin Attachment Control Kit, a 14-Pin Attachment T-Harness Kit is required)	\$5,315.00	24.0%	\$0.00	\$4,039.40
--	---	------------	-------	--------	------------

(S510, S550, S550H, S530, S530H, S570, S570H, S590, S590H) (S630, S650, S740, S750, S770, S850) (A770) (T550, T550H, T590, T590H) (T630, T650, T750, T770, T870) 6905806	<b>84" Angle Broom</b> (Loader must be equipped with an Attachment Control Kit) (When used on loaders equipped with a 14-Pin Attachment Control Kit, a 14-Pin Attachment T-Harness Kit is required)	\$6,080.00	24.0%	\$0.00	\$4,620.80
---	---	------------	-------	--------	------------

Part Number	Augers Description	SLP in US\$	Discount Percent	Labor	Price
-------------	--------------------	-------------	------------------	-------	-------

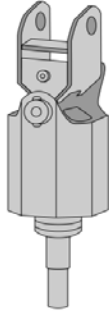

6808799	<p>(S70, S450 S510, S550, S530, S570, S590) (T450)</p> <p><b>Model 10 Auger Drive Unit</b></p> <p>(Must also order Mounting Frame and Bit) (Must order mounting frame, light duty bit and swing stop kit when installing on MT50 and MT52)</p>	\$1,305.00	24.0%	\$0.00	\$991.80
6809442	<p>(S450, S510, S550, S530, S570, S590, S220, S250, S300, S330)</p> <p>(S630*, S650*, S740*, S750*, S770*, S850*) (A770*)</p> <p>(T450, T550, T590, T250, T300, T320) (T630*, T650*, T750*, T770*, T870*)</p> <p><b>Model 15C Auger Drive Unit</b></p> <p>(Must also order Mounting Frame and Bit)</p> <p>(Auger drive unit is shipped with a 7/8" round bit retention pin, if used in conjunction with a hex bit a 5/8" Pin Kit P/N 6809733 is required.)</p>	\$1,580.00	24.0%	\$0.00	\$1,200.80
7145345	<p><b>Model 15H Hex Shaft Auger Drive Unit</b></p> <p>(Must also order Mounting Frame and Bit)</p>	\$1,580.00	24.0%	\$0.00	\$1,200.80
6809445	<p>(S450, S510, S550, S550H, S530, S530H, S570, S570H, S590, S590H, S220, S220H, S250, S250H, S300, S300H, S330, S330H) (S630*, S630H*, S650*, S650H*, S740*, S750*, S750H*, S770*, S770H*, S850*, S850H*) (A300, A300H) (A770*, A770H*)</p> <p>(T450, T550, T550H, T590, T590H, T250, T250H, T300, T300H, T320, T320H)</p> <p>(T630*, T630H*, T650*, T650H*, T750*, T750H*, T770*, T770H*, T870*, T870H*)</p> <p><b>Model 30C Auger Drive Unit</b></p> <p>(Must also order Mounting Frame and Bit)</p> <p>(Auger drive unit is shipped with a 7/8" round bit retention pin, if used in conjunction with a hex bit a 5/8" Pin Kit P/N 6809733 is required.)</p>	\$2,120.00	24.0%	\$0.00	\$1,611.20
7138264	<p><b>Model 30H Hex Shaft Auger Drive Unit</b></p> <p>(Must also order Mounting Frame and Bit)</p>	\$2,120.00	24.0%	\$0.00	\$1,611.20

6812946	<b>Mounting Frame, 463, S70</b> (Includes Mounting Hardware)	\$435.00	24.0%	\$0.00	\$330.60
(S450-S330, S630-S850, A770, T450, T550, T590, T630, T650, T750, T770, T870)					
6812980	<b>Mounting Frame,</b> (Includes Mounting Hardware) *Must also order Bumper Kit p/n 7172609 for M-Series Loaders – S630, S650, S870, T630, T650, T870 *Must also order Swing Stop Kit, PN 6811444 for Mini-Track Loaders. *Auger Bits are not Included with the Auger Drive Units.	\$370.00	24.0%	\$0.00	\$281.20
(S510, S530, S550, S570, S590, S630, S650, S740, S750, S770, S850) (A770)					
(T550, T590, T630, T650, T750, T770, T870)					
7220280	<b>Model 35PH Planetary Auger Drive Unit</b> (Must also order Mounting Frame and Bit)	\$3,220.00	24.0%	\$0.00	\$2,447.20
(S550H, S570H, S590H, S630, S650, S740, S750, S770, S850) (A770)					
(T550H, T590H, T630, T650, T750, T770, T870)					
7227985	<b>Model 50PH Planetary Auger Drive Unit</b> (Must also order Mounting Frame and Bit)	\$3,765.00	24.0%	\$0.00	\$2,861.40
(S510 - S850, A770, T550 - T870)					
7223507	<b>35PH/50PH Mounting Frame,</b> (Includes Mounting Hardware)	\$465.00	24.0%	\$0.00	\$353.40

**Auger Drive & Bit Recommendations**

**Model 10 Augers—Recommended bit size 6", 9", 12", 15", 16", 18"**

**Model 15C and 30C Augers—Recommended bit size 6", 9", 12", 15", 18", 24", 30", 36"**

**Model 15H and 30H Augers—Recommended bit size 6", 9", 12", 15", 18", 24", 30", 36"**

**Model 35PH and 50PH Augers—Recommended bit size - HD - 8", 12", 18", 24", 30", 36", 48" And Rock Bits - 8", 12", 18", 24", 30"**

**Light Duty, Standard Duty, Heavy Duty and Rock Bits are Available.**

**Auger bit combinations should be used as a guideline. Recommendations are based upon average digging conditions.**

Part Number	Bob-Tach Mounted Backhoe Description	SLP in US\$	Discount Percent	Labor	Price
-------------	--------------------------------------	-------------	------------------	-------	-------

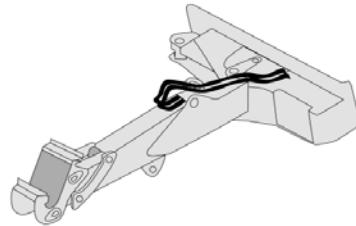

(S510, S550, S530, S570, S590) (T550, T590)

6906767	<b>Bob-Tach Mounted Backhoe</b> (Must also order bucket, see Backhoe Bucket pages) (Loader must be equipped with an Attachment Control Kit) (If installing on loader with 14-Pin Attachment Control, must also order 14-pin Attachment T-Harness P/N 6725383) (Bob-Tach Mounted Backhoe is NOT compatible with Rear Stabilizers)	\$4,640.00	24.0%	\$0.00	\$3,526.40
---------	---	------------	-------	--------	------------

Part Number	Accessories Description	SLP in US\$	Discount Percent	Labor	Price
-------------	-------------------------	-------------	------------------	-------	-------

7104321	<b>Hydraulic Clamp</b> (Includes cylinder, hoses & pins)(Must also order Auxiliary Hydraulic Kit) (Price includes \$270 for installation)	\$1,560.00	24.0%	\$270.00	\$1,455.60
---------	---	------------	-------	----------	------------

Part Number	Backhoe Buckets Description	SLP in US\$	Discount Percent	Labor	Price
-------------	-----------------------------	-------------	------------------	-------	-------

**Backhoe Buckets – Current**

(Bob-Tach Mounted Backhoe X-Change™ Style)

6735375	13" Trenching Bucket, 3 Bolt-On Teeth	\$590.00	24.0%	\$0.00	\$448.40
6735380	16" Trenching Bucket, 4 Bolt-On Teeth	\$620.00	24.0%	\$0.00	\$471.20
6735395	20" Trenching Bucket, 4 Bolt-On Teeth	\$670.00	24.0%	\$0.00	\$509.20

Part Number	Backhoe	SLP in US\$	Discount Percent	Labor	Price
-------------	---------	-------------	------------------	-------	-------

Number	Description	SLP in US\$	Discount Percent	Labor	Price
(S70) 6906310	<b>406 Backhoe (Mounting Kit included with Backhoe)</b> (Must also order bucket, see Backhoe Bucket pages)	\$5,960.00	0.0%	\$0.00	\$5,960.00
(S70) 6906864	<b>506 Backhoe</b> (Must also order Mounting Kit and Bucket, see Backhoe Bucket pages)	\$6,145.00	0.0%	\$0.00	\$6,145.00

Part Number	Accessories Description	SLP in US\$	Discount Percent	Labor	Price
6958101	<b>Mounting Kit for 506 Backhoe</b> (Required when ordering 506 Backhoe - to be installed on S70)	\$190.00	0.0%	\$180.00	\$370.00

Part Number	Backhoe Buckets Description	SLP in US\$	Discount Percent	Labor	Price
(406/506 Pin-On Style)					
6715495	9" Trenching Bucket, 2 Bolt-On Teeth	\$420.00	0.0%	\$0.00	\$420.00
6715496	12" Trenching Bucket, 3 Bolt-On Teeth	\$465.00	0.0%	\$0.00	\$465.00
6715497	16" Trenching Bucket, 3 Bolt-On Teeth	\$510.00	0.0%	\$0.00	\$510.00
7109522	18" Trenching Bucket, 4 Bolt-On Teeth	\$525.00	0.0%	\$0.00	\$525.00
6715498	20" Trenching Bucket, 4 Bolt-On Teeth	\$555.00	0.0%	\$0.00	\$555.00

Part Number	Boring Unit Description	SLP in US\$	Discount Percent	Labor	Price
-------------	-------------------------	-------------	------------------	-------	-------

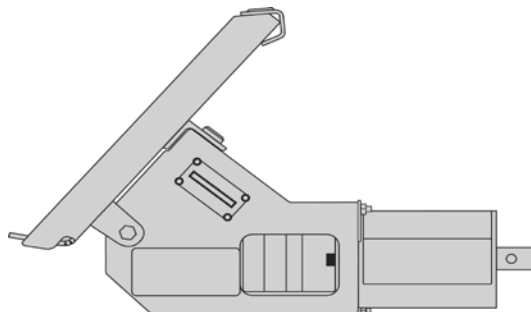

(S70)

7110098

**Boring Unit**

(Includes drive unit and guide tool)

(Boring Tool Kit is available)

\$2,075.00

24.0%

\$0.00

\$1,577.00

Part Number	Box Blade Description	SLP in US\$	Discount Percent	Labor	Price
-------------	-----------------------	-------------	------------------	-------	-------

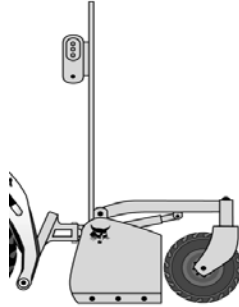

Box Blade with Laser Receiver

(S510, S550, S530, S570, S590, S220, S250, S300, S330) (S630, S650, S740, S750, S770)  
 (A770) (T450, T550, T590) (T630, T650)

6906574	<b>84" Box Blade</b> (Used for rough grading and landscaping)	\$4,060.00	24.0%	\$0.00	\$3,085.60
---------	--	------------	-------	--------	------------

(S510, S550, S530, S570, S590, S220, S250, S300, S330) (S630, S650, S740, S750, S770)  
 (A770)(T450, T550, T590) (T630, T650)

6906676	<b>84" Box Blade With Laser Mounting</b> (Must also order receiver p/n 7160486) (Approved for use only on BICS loaders.) (Includes integrated laser control) (May also need laser transmitter and tripod—unless customer has this equipment.) (The laser receiver will work with most rotating laser beacons) (Loader must be equipped with an Attachment Control Kit) (If installing on loader with 14-Pin Attachment Control, must also order 14-Pin Attachment T-Harness P/N 7164095)	\$6,275.00	24.0%	\$0.00	\$4,769.00
---------	--	------------	-------	--------	------------

Part Number	Accessories Description	SLP in US\$	Discount Percent	Labor	Price
-------------	-------------------------	-------------	------------------	-------	-------

6680073	<b>Laser Transmitter, Dual Slope</b> (Trimble GL722)	\$7,720.00	24.0%	\$0.00	\$5,867.20
---------	---	------------	-------	--------	------------

6697973	<b>Laser Transmitter, Dual Slope</b> (Trimble GL422; includes CR600 receiver)	\$2,300.00	24.0%	\$0.00	\$1,748.00
---------	--	------------	-------	--------	------------



6697972	<b>Laser Transmitter, Single Slope</b> (Trimble GL412)	\$1,930.00	24.0%	\$0.00	\$1,466.80
6688806	<b>Tripod</b>	\$240.00	24.0%	\$0.00	\$182.40
7160486	<b>Laser Receiver, BLR2</b> (For use with Laser Box Blade S/N 657500370 and above). (May also need a laser transmitter and tripod—unless customer has this equipment.) (The laser receivers will work with most rotating laser transmitters. (Must order 1 for use with laser kit)	\$1,940.00	24.0%	\$0.00	\$1,474.40

Part Number	Breaker, Hydraulic Description	SLP in US\$	Discount Percent	Labor	Price
-------------	--------------------------------	-------------	------------------	-------	-------



(S70) 7113419	<b>HB680 Breaker</b> (Includes Nail Point, fixing cap bolts, cradle, isolation mount, gauge tool, retainer clip and hose protector) (Must also order Loader Mounting Frame and Hose Kit) (Special Applications Kit must be used when operating a Hydraulic Breaker) (When installing on MT50, must also order Shutdown Kit, p/n 6735945)	\$4,430.00	24.0%	\$0.00	\$3,366.80
------------------	---	------------	-------	--------	------------

**Mounting Frames –HB680**

7113736	<b>Loader Mounting Frame</b> (Must also order a hose kit, P/N 6727411)	\$630.00	24.0%	\$0.00	\$478.80
7150181	<b>Loader X-Change Mounting Frame</b> (Uses X-Change pin-through design) (Must also order Breaker X-Change Mounting Cap p/n 7113656. This allows breaker with X-Change Mounting Cap to be installed on loader) (Must also order a hose kit, P/N 6727411)	\$925.00	24.0%	\$0.00	\$703.00
7113656	<b>X-Change Mounting Cap</b>	\$410.00	24.0%	\$0.00	\$311.60

**Accessories – HB680**

6727411	<b>Hose Kit</b> (Includes hoses and quick couplers)	\$180.00	24.0%	\$0.00	\$136.80
---------	--	----------	-------	--------	----------

Part Number	HB880 Breaker Description	SLP in US\$	Discount Percent	Labor	Price
-------------	------------------------------	-------------	---------------------	-------	-------

(S450, S510, S550, S530, S570, S590) (T450, T550, T590)

7113420	<b>HB880 Breaker</b> (Includes Nail Point, flow control valve, fixing cap bolts, cradle, isolation mount, gauge tool, retainer clip and hose protector) (Must also order Loader Mounting Frame and Hose Kit) (Special Applications Kit must be used when operating a Hydraulic Breaker)	\$6,275.00	24.0%	\$0.00	\$4,769.00
---------	---	------------	-------	--------	------------

**Mounting Frame – HB880**

7113737	<b>Loader Mounting Frame</b> (Breaker mounting frame allows for breaking horizontal or vertical surfaces.) (Must also order a hose kit, P/N 7114764)	\$670.00	24.0%	\$0.00	\$509.20
7113738	<b>Horizontal Loader Mounting Frame</b> (Recommended mounting frame for horizontal surface breaking only) (Must also order a hose kit, P/N 7114764)	\$710.00	24.0%	\$0.00	\$539.60
7141800	<b>Loader X-Change Mounting Frame</b> Allows breaker with X-Change Mounting Cap to be installed on loader, breaker can then be used on excavator and loader. Uses X-Change pin-through design. (Breaker mounting frame allows for breaking horizontal or vertical surfaces) (Must also order Breaker X-Change Mounting Cap P/N 7113657) (Must also order a hose kit, P/N 7114764)	\$985.00	24.0%	\$0.00	\$748.60
7113657	<b>X-Change Mounting Cap</b>	\$410.00	24.0%	\$0.00	\$311.60

**Accessories – HB880**

7114764	<b>Hose Kit</b> (Ship Weight 20 lbs.)	\$205.00	24.0%	\$0.00	\$155.80
---------	--	----------	-------	--------	----------

Part Number	HB980 Breaker Description	SLP in US\$	Discount Percent	Labor	Price
-------------	------------------------------	-------------	---------------------	-------	-------

(S450, S510, S550, S530, S570, S590, S220, S250, S300, S330)

(S630\*, S650\*, S750\*, S740\*, S770\*) (A770\*)

(T450, T550, T590, T250, T300, T320) (T630\*, T650\*, T750\*, T770\*)

7113421	<b>HB980 Breaker</b> (Includes Nail Point, flow control valve, fixing cap bolts, cradle, isolation mount, gauge tool, retainer clip and hose protector)	\$7,860.00	24.0%	\$0.00	\$5,973.60
---------	--	------------	-------	--------	------------

(Must also order Loader Mounting Frame and Hose Kit)  
 (Special Applications Kit must be used when operating a Hydraulic Breaker)  
**\*Must also order Flow Control Valve Kit, for M-Series p/n 7177744**

**Mounting Frame –HB980**

<b>7113737</b>	<b>Loader Mounting Frame</b> (Breaker mounting frame allows for breaking horizontal or vertical surfaces.) (Must also order a hose kit, P/N 7114764)	<b>\$670.00</b>	<b>24.0%</b>	<b>\$0.00</b>	<b>\$509.20</b>
<b>7113738</b>	<b>Horizontal Loader Mounting Frame</b> (Recommended mounting frame for horizontal surface breaking only) (Must also order a hose kit, P/N 7114764)	<b>\$710.00</b>	<b>24.0%</b>	<b>\$0.00</b>	<b>\$539.60</b>
<b>7141800</b>	<b>Loader X-Change Mounting Frame</b> Allows breaker with X-Change Mounting Cap to be installed on loader, breaker can then be used on excavator and loader. Uses X-Change pin-through design. (Breaker mounting frame allows for breaking horizontal or vertical surfaces) (Must also order Breaker X-Change Mounting Cap P/N 7113657) (Must also order a hose kit, P/N 7114764)	<b>\$985.00</b>	<b>24.0%</b>	<b>\$0.00</b>	<b>\$748.60</b>
<b>7113657</b>	<b>X-Change Mounting Cap</b>	<b>\$410.00</b>	<b>24.0%</b>	<b>\$0.00</b>	<b>\$311.60</b>

**Accessories –HB980**

<b>7114764</b>	<b>Hose Kit</b>	<b>\$205.00</b>	<b>24.0%</b>	<b>\$0.00</b>	<b>\$155.80</b>
----------------	-----------------	-----------------	--------------	---------------	-----------------

Part Number	HB1180 Breaker Description	SLP in US\$	Discount Percent	Labor	Price
-------------	----------------------------	-------------	------------------	-------	-------

(S220, S250, S300, S330) (S630, S650, S740, S750, S770, S850) (A300) (A770) (T250, T300, T320) (T630, T650, T750, T770, T870)

7115923	<b>HB1180 Breaker</b> (Includes Nail Point, fixing cap bolts, cradle, isolation mount, gauge tool, retainer clip and hose protector) (Must also order Loader Mounting Frame and Hose Kit) (Special Applications Kit must be used when operating a Hydraulic Breaker)	\$10,335.00	24.0%	\$0.00	\$7,854.60
---------	--	-------------	-------	--------	------------

**Mounting Frame –HB1180**

7115937	<b>Loader Mounting Frame</b> (Breaker mounting frame allows for breaking horizontal or vertical surfaces.) (Must also order a hose kit, P/N 7114764)	\$765.00	24.0%	\$0.00	\$581.40
---------	--	----------	-------	--------	----------

7141800	<b>Loader X-Change Mounting Frame</b> Allows breaker with X-Change Mounting Cap to be installed on loader, breaker can then be used on excavator and loader. Uses X-Change pin-through design. (Breaker mounting frame allows for breaking horizontal or vertical surfaces) (Must also order Breaker X-Change Mounting Cap P/N 7117325) (Must also order a hose kit, P/N 7114764)	\$985.00	24.0%	\$0.00	\$748.60
---------	---	----------	-------	--------	----------

7117325	<b>X-Change Mounting Cap</b>	\$555.00	24.0%	\$0.00	\$421.80
---------	------------------------------	----------	-------	--------	----------

**Accessories –HB1180**

7114764	<b>Hose Kit</b>	\$205.00	24.0%	\$0.00	\$155.80
---------	-----------------	----------	-------	--------	----------

Part Number	HB1380 Breaker Description	SLP in US\$	Discount Percent	Labor	Price
-------------	----------------------------	-------------	------------------	-------	-------

(S220, S250, S300, S330) (S740, S750, S770, S850) (A300) (A770) (T250, T300, T320) (T750, T770, T870)

7157576	<b>HB1380 Breaker</b> (Includes Nail Point, fixing cap bolts, cradle, isolation mount, gauge tool, retainer clip and hose protector) (Must also order Loader Mounting Frame and Hose Kit) (Special Applications Kit must be used when operating a Hydraulic Breaker)	\$12,825.00	24.0%	\$0.00	\$9,747.00
---------	--	-------------	-------	--------	------------

**Mounting Frame –HB1380**

7115937	<b>Loader Mounting Frame</b>	\$765.00	24.0%	\$0.00	\$581.40
---------	------------------------------	----------	-------	--------	----------

(Breaker mounting frame allows for breaking horizontal or vertical surfaces.)  
 (Must also order a hose kit, P/N 7114764)

Accessories – HB1380

7114764	Hose Kit	\$205.00	24.0%	\$0.00	\$155.80
---------	----------	----------	-------	--------	----------

Part Number	HB2380 Breaker Description	SLP in US\$	Discount Percent	Labor	Price
-------------	----------------------------	-------------	------------------	-------	-------

(S220, S250, S300, S330) (S740, S750, S770, S850) (A300) (A770) (T250, T300, T320) (T750, T770, T870)

7133203	<b>HB2380 Breaker</b> (Includes Nail Point, fixing cap bolts, cradle, isolation mount, and hose protector) (Must also order Loader Mounting Frame and Hose Kit) (Special Applications Kit must be used when operating a Hydraulic Breaker)	\$15,760.00	24.0%	\$0.00	\$11,977.60
---------	---	-------------	-------	--------	-------------

Mounting Frames – HB2380

7115937	<b>Loader Mounting Frame</b> (Breaker mounting frame allows for breaking horizontal or vertical surfaces.) (Must also order a hose kit, P/N 7114764)	\$765.00	24.0%	\$0.00	\$581.40
---------	--	----------	-------	--------	----------

Accessories – HB2380

7114764	Hose Kit	\$205.00	24.0%	\$0.00	\$155.80
---------	----------	----------	-------	--------	----------

Part Number	Brush Saw Description	SLP in US\$	Discount Percent	Labor	Price
-------------	-----------------------	-------------	------------------	-------	-------

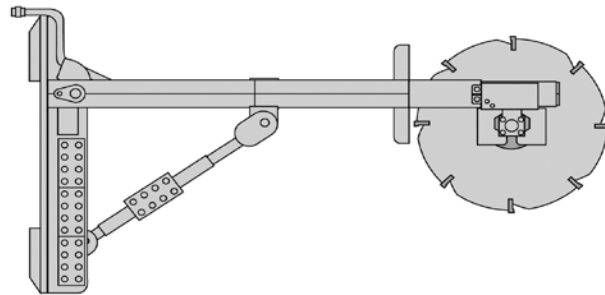

(S450, S510, S550, S530, S570, S590, S220, S250, S300, S330)  
 (S630, S650, S740, S750, S770, S850) (A770)

(T450, T550, T590, T250, T300, T320) (T630, T650, T750, T770, T870)

7121030	<b>Brush Saw</b> (Special Applications kit must be installed on loader when operating Brush Saw)	\$6,215.00	24.0%	\$0.00	\$4,723.40
---------	---	------------	-------	--------	------------

Part Number	Bruschcat Rotary Cutter Description	SLP in US\$	Discount Percent	Labor	Price
-------------	-------------------------------------	-------------	------------------	-------	-------

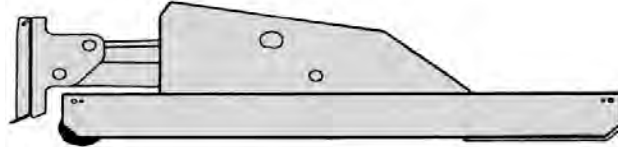

(S450, S510, S530, S550, S530, S570, S590) (T450, T550, T590)					
7234049	66" Brushcat Rotary Cutter, Standard Flow (RC66)	\$6,120.00	24.0%	\$0.00	\$4,651.20

(S550H, S570H, S590H) (T550H, T590H)					
7233014	66" Brushcat Rotary Cutter, High Flow (RC66HF)	\$6,200.00	24.0%	\$0.00	\$4,712.00

(S510, S530, S550, S570, S590, S630, S650, S740, S750, S770) (A770)					
(T550, T590, T630, T650, T750, T770)					
7218087	72" Brushcat Rotary Cutter, Standard Flow (RC72)	\$6,295.00	24.0%	\$0.00	\$4,784.20

(S550H, S570H, S590H, S630H, S650H, S740H, S750H, S770H) (A770H)					
(T550H, T590H, T630H, T650H, T750H, T770H)					
7233002	72" Brushcat Rotary Cutter, High Flow (RC72HF)	\$6,540.00	24.0%	\$0.00	\$4,970.40

(S630H, S650H, S740H, S750H, S770H, S850H) (A770H)					
(T630H, T650H, T750H, T770H, T870H)					
7233092	80" Brushcat Rotary Cutter, High Flow (RC80)	\$6,910.00	24.0%	\$0.00	\$5,251.60

Part Number	Buckets Description	SLP in US\$	Discount Percent	Labor	Price
-------------	---------------------	-------------	------------------	-------	-------

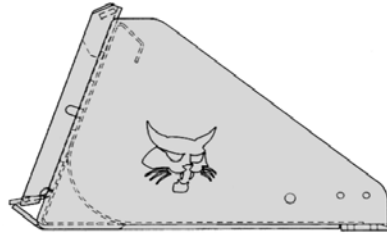

(S70)					
7117432	36" Dirt Bucket ♦	\$485.00	24.0%	\$0.00	\$368.60
7117433	44" Dirt Bucket ♦	\$515.00	24.0%	\$0.00	\$391.40
7114488	36" General Purpose Bucket ♦	\$530.00	24.0%	\$0.00	\$402.80
7114581	44" General Purpose Bucket ♦	\$560.00	24.0%	\$0.00	\$425.60
7114583	50" General Purpose Bucket ♦	\$585.00	24.0%	\$0.00	\$444.60
(S450)					
6737399	56" Constr./Ind. Bucket ♦	\$940.00	24.0%	\$0.00	\$714.40
6731403	62" Constr./Ind. Bucket ♦	\$855.00	24.0%	\$0.00	\$649.80
6731406	68" Constr./Ind. Bucket ♦	\$970.00	24.0%	\$0.00	\$737.20
6557599	54" Fertilizer & Grain Bucket D	\$805.00	24.0%	\$0.00	\$611.80
6558681	60" Fertilizer & Grain Bucket D	\$820.00	24.0%	\$0.00	\$623.20
7114584	56" General Purpose Bucket ♦	\$645.00	24.0%	\$0.00	\$490.20
7114585	62" General Purpose Bucket ♦	\$680.00	24.0%	\$0.00	\$516.80
7114586	68" General Purpose Bucket ♦	\$695.00	24.0%	\$0.00	\$528.20
7114587	74" General Purpose Bucket ♦	\$740.00	24.0%	\$0.00	\$562.40
7101903	56" Low Profile Bucket ♦	\$950.00	24.0%	\$0.00	\$722.00
6731415	62" Low Profile Bucket ♦	\$870.00	24.0%	\$0.00	\$661.20
6731418	68" Low Profile Bucket ♦	\$980.00	24.0%	\$0.00	\$744.80
7184103	68" Snow & Light Material Bucket D	\$1,120.00	24.0%	\$0.00	\$851.20
7184105	74" Snow & Light Material Bucket D	\$1,185.00	24.0%	\$0.00	\$900.60

**D** Buckets have holes predrilled to accept bolt-on cutting edges.

♦ Buckets have holes predrilled to accept bolt-on cutting edges or bolt-on teeth.

(S510, S550, S530, S570, S590)

6731403	62" Constr./Ind. Bucket ♦	\$855.00	24.0%	\$0.00	\$649.80
6731406	68" Constr./Ind. Bucket ♦	\$970.00	24.0%	\$0.00	\$737.20
7124426	68" Constr./Ind. Heavy Duty Bucket ♦ (S530, S570, S590 only) Recommended for severe-duty use (Not approved for use with the 55" Farm Grapple P/N 7176977)	\$1,375.00	24.0%	\$0.00	\$1,045.00
6731409	74" Constr./Ind. Bucket ♦	\$1,050.00	24.0%	\$0.00	\$798.00
6558681	60" Fertilizer & Grain Bucket D	\$820.00	24.0%	\$0.00	\$623.20
6706479	66" Fertilizer & Grain Bucket D	\$1,020.00	24.0%	\$0.00	\$775.20
6706483	72" Fertilizer & Grain Bucket D	\$1,185.00	24.0%	\$0.00	\$900.60
7114585	62" General Purpose Bucket ♦ (Only for S510, S530, S550, S570)	\$680.00	24.0%	\$0.00	\$516.80
7114586	68" General Purpose Bucket ♦ (Only for S510, S530, S550, S570)	\$695.00	24.0%	\$0.00	\$528.20
7114587	74" General Purpose Bucket ♦ (Only for S510, S530, S550, S570)	\$740.00	24.0%	\$0.00	\$562.40
6731415	62" Low Profile Bucket ♦	\$870.00	24.0%	\$0.00	\$661.20
6731418	68" Low Profile Bucket ♦	\$980.00	24.0%	\$0.00	\$744.80
6731421	74" Low Profile Bucket ♦	\$1,065.00	24.0%	\$0.00	\$809.40
7184103	68" Snow & Light Material Bucket D	\$1,120.00	24.0%	\$0.00	\$851.20
7184105	74" Snow & Light Material Bucket D	\$1,185.00	24.0%	\$0.00	\$900.60
7184110	80" Snow & Light Material Bucket D	\$1,300.00	24.0%	\$0.00	\$988.00
7184098	88" Snow & Light Material Bucket D (S530, S570, S590 Only)	\$1,385.00	24.0%	\$0.00	\$1,052.60

(S630, S650)

6731406	68" Constr./Ind. Bucket ♦ (for use with offset rims only)	\$970.00	24.0%	\$0.00	\$737.20
7124426	68" Constr./Ind. Heavy Duty Bucket ♦ (S530, S570, S590 only) Recommended for severe-duty use (Not approved for use with the 55" Farm Grapple P/N 7176977)	\$1,375.00	24.0%	\$0.00	\$1,045.00
6731409	74" Constr./Ind. Bucket ♦	\$1,050.00	24.0%	\$0.00	\$798.00
6732305	74" Constr./Ind. Heavy Duty Bucket ♦ (Recommended for severe-duty use) (Not approved for use with the 55" Farm Grapple, P/N 7176977)	\$1,425.00	24.0%	\$0.00	\$1,083.00
6731412	80" Constr./Ind. Bucket ♦	\$1,145.00	24.0%	\$0.00	\$870.20
6726344	80" Constr./Ind. Heavy Duty Bucket ♦ (Recommended for severe-duty use) (Not approved for use with the 55" Farm Grapple, P/N 7176977)	\$1,535.00	24.0%	\$0.00	\$1,166.60
7125917	84" Constr./Ind. Heavy Duty Bucket ♦ (For use with S650 only) (Recommended for severe-duty use) (Not approved for use with the 55" Farm Grapple, P/N 7176977)	\$1,610.00	24.0%	\$0.00	\$1,223.60

**D** Buckets have holes predrilled to accept bolt-on cutting edges.

♦ Buckets have holes predrilled to accept bolt-on cutting edges or bolt-on teeth.



<b>(S630, S650)</b>					
6706479	<b>66" Fertilizer &amp; Grain Bucket D</b> (for use with offset rims only)	\$1,020.00	24.0%	\$0.00	\$775.20
6706483	<b>72" Fertilizer &amp; Grain Bucket D</b>	\$1,185.00	24.0%	\$0.00	\$900.60
6731418	<b>68" Low Profile Bucket ♦</b> (for use with offset rims only)	\$980.00	24.0%	\$0.00	\$744.80
6731421	<b>74" Low Profile Bucket ♦</b>	\$1,065.00	24.0%	\$0.00	\$809.40
6731424	<b>80" Low Profile Bucket ♦</b>	\$1,160.00	24.0%	\$0.00	\$881.60
7184103	<b>68" Snow &amp; Light Material Bucket D</b> (For use with offset rims only)	\$1,120.00	24.0%	\$0.00	\$851.20
7184105	<b>74" Snow &amp; Light Material Bucket D</b>	\$1,185.00	24.0%	\$0.00	\$900.60
7184110	<b>80" Snow &amp; Light Material Bucket D</b>	\$1,300.00	24.0%	\$0.00	\$988.00
7184098	<b>88" Snow &amp; Light Material Bucket D</b>	\$1,385.00	24.0%	\$0.00	\$1,052.60
<b>(S740, S750, S770)</b>					
6731406	<b>68" Constr./Ind. Bucket ♦</b> (For use with offset rims only)	\$970.00	24.0%	\$0.00	\$737.20
7124426	<b>68" Constr./Ind. Heavy Duty Bucket ♦</b> (S530, S570, S590 only) Recommended for severe-duty use (Not approved for use with the 55" Farm Grapple P/N 7176977)	\$1,375.00	24.0%	\$0.00	\$1,045.00
6731409	<b>74" Constr./Ind. Bucket ♦</b>	\$1,050.00	24.0%	\$0.00	\$798.00
6732305	<b>74" Constr./Ind. Heavy Duty Bucket ♦</b> (Not approved for use with the 55" Farm Grapple, P/N 7176977)	\$1,425.00	24.0%	\$0.00	\$1,083.00
6731412	<b>80" Constr./Ind. Bucket ♦</b>	\$1,145.00	24.0%	\$0.00	\$870.20
6726344	<b>80" Constr./Ind. Heavy Duty Bucket ♦</b> (Not approved for use with the 55" Farm Grapple, P/N 7176977)	\$1,535.00	24.0%	\$0.00	\$1,166.60
7125917	<b>84" Constr./Ind. Heavy Duty Bucket ♦</b> (Not approved for use with the 55" Farm Grapple, P/N 7176977)	\$1,610.00	24.0%	\$0.00	\$1,223.60
6726328	<b>88" Constr./Ind. Heavy Duty Bucket ♦</b> (Not approved for use with the 55" Farm Grapple, P/N 7176977)	\$1,685.00	24.0%	\$0.00	\$1,280.60
7173162	<b>82" Constr./Ind. Severe Duty Bucket ♦</b>	\$1,840.00	24.0%	\$0.00	\$1,398.40
7173161	<b>88" Constr./Ind. Severe Duty Bucket ♦</b>	\$1,975.00	24.0%	\$0.00	\$1,501.00
6706483	<b>72" Fertilizer &amp; Grain Bucket D</b>	\$1,185.00	24.0%	\$0.00	\$900.60
6731418	<b>68" Low Profile Bucket ♦</b> (for use with offset rims only)	\$980.00	24.0%	\$0.00	\$744.80
6731421	<b>74" Low Profile Bucket ♦</b>	\$1,065.00	24.0%	\$0.00	\$809.40
6731424	<b>80" Low Profile Bucket ♦</b>	\$1,160.00	24.0%	\$0.00	\$881.60
7184103	<b>68" Snow &amp; Light Material Bucket D</b> (For use with offset rims only)	\$1,120.00	24.0%	\$0.00	\$851.20
7184105	<b>74" Snow &amp; Light Material Bucket D</b>	\$1,185.00	24.0%	\$0.00	\$900.60
7184110	<b>80" Snow &amp; Light Material Bucket D</b>	\$1,300.00	24.0%	\$0.00	\$988.00
7184098	<b>88" Snow &amp; Light Material Bucket D</b>	\$1,385.00	24.0%	\$0.00	\$1,052.60
6727787	<b>100" Snow &amp; Light Material Bucket ♦</b>	\$1,805.00	24.0%	\$0.00	\$1,371.80

**D** Buckets have holes predrilled to accept bolt-on cutting edges.

**♦** Buckets have holes predrilled to accept bolt-on cutting edges or bolt-on teeth.

(S850)					
6726344	<b>80" Constr./Ind. Heavy Duty Bucket ♦</b>	\$1,535.00	24.0%	\$0.00	\$1,166.60
	(Not approved for use with the 55" Farm Grapple, P/N 7176977)				
7125917	<b>84" Constr./Ind. Heavy Duty Bucket ♦</b>	\$1,610.00	24.0%	\$0.00	\$1,223.60
	(Not approved for use with the 55" Farm Grapple, P/N 7176977)				
6726328	<b>88" Constr./Ind. Heavy Duty Bucket ♦</b>	\$1,685.00	24.0%	\$0.00	\$1,280.60
	(Not approved for use with the 55" Farm Grapple, P/N 7176977)				
7173162	<b>82" Constr./Ind. Severe Duty Bucket ♦</b>	\$1,840.00	24.0%	\$0.00	\$1,398.40
7173161	<b>88" Constr./Ind. Severe Duty Bucket ♦</b>	\$1,975.00	24.0%	\$0.00	\$1,501.00
7184110	<b>80" Snow &amp; Light Material Bucket D</b>	\$1,300.00	24.0%	\$0.00	\$988.00
7184098	<b>88" Snow &amp; Light Material Bucket D</b>	\$1,385.00	24.0%	\$0.00	\$1,052.60
6727787	<b>100" Snow &amp; Light Material Bucket ♦</b>	\$1,805.00	24.0%	\$0.00	\$1,371.80
(A770)					
6731409	<b>74" Constr./Ind. Bucket ♦</b>	\$1,050.00	24.0%	\$0.00	\$798.00
6732305	<b>74" Constr./Ind. Heavy Duty Bucket ♦</b>	\$1,425.00	24.0%	\$0.00	\$1,083.00
	(Not approved for use with the 55" Farm Grapple, P/N 7176977)				
6731412	<b>80" Constr./Ind. Bucket ♦</b>	\$1,145.00	24.0%	\$0.00	\$870.20
6726344	<b>80" Constr./Ind. Heavy Duty Bucket ♦</b>	\$1,535.00	24.0%	\$0.00	\$1,166.60
	(Not approved for use with the 55" Farm Grapple, P/N 7176977)				
7125917	<b>84" Constr./Ind. Heavy Duty Bucket ♦</b>	\$1,610.00	24.0%	\$0.00	\$1,223.60
	(Not approved for use with the 55" Farm Grapple, P/N 7176977)				
6726328	<b>88" Constr./Ind. Heavy Duty Bucket ♦</b>	\$1,685.00	24.0%	\$0.00	\$1,280.60
	(Not approved for use with the 55" Farm Grapple, P/N 7176977)				
7173162	<b>82" Constr./Ind. Severe Duty Bucket ♦</b>	\$1,840.00	24.0%	\$0.00	\$1,398.40
7173161	<b>88" Constr./Ind. Severe Duty Bucket ♦</b>	\$1,975.00	24.0%	\$0.00	\$1,501.00
6706483	<b>72" Fertilizer &amp; Grain Bucket D</b>	\$1,185.00	24.0%	\$0.00	\$900.60
6731421	<b>74" Low Profile Bucket ♦</b>	\$1,065.00	24.0%	\$0.00	\$809.40
6731424	<b>80" Low Profile Bucket ♦</b>	\$1,160.00	24.0%	\$0.00	\$881.60
7184105	<b>74" Snow &amp; Light Material Bucket D</b>	\$1,185.00	24.0%	\$0.00	\$900.60
7184110	<b>80" Snow &amp; Light Material Bucket D</b>	\$1,300.00	24.0%	\$0.00	\$988.00
7184098	<b>88" Snow &amp; Light Material Bucket D</b>	\$1,385.00	24.0%	\$0.00	\$1,052.60
6727787	<b>100" Snow &amp; Light Material Bucket ♦</b>	\$1,805.00	24.0%	\$0.00	\$1,371.80

**D** Buckets have holes predrilled to accept bolt-on cutting edges.

**♦** Buckets have holes predrilled to accept bolt-on cutting edges or bolt-on teeth.

<b>(T450)</b>					
6737399	56" Constr./Ind. Bucket ♦	\$940.00	24.0%	\$0.00	\$714.40
6731403	62" Constr./Ind. Bucket ♦	\$855.00	24.0%	\$0.00	\$649.80
6731406	68" Constr./Ind. Bucket ♦	\$970.00	24.0%	\$0.00	\$737.20
6557599	54" Fertilizer & Grain Bucket D	\$805.00	24.0%	\$0.00	\$611.80
6558681	60" Fertilizer & Grain Bucket D	\$820.00	24.0%	\$0.00	\$623.20
7101903	56" Low Profile Bucket ♦	\$950.00	24.0%	\$0.00	\$722.00
6731415	62" Low Profile Bucket ♦	\$870.00	24.0%	\$0.00	\$661.20
(Must also order Side Edge Cutting kit p/n 6732094 when used with wide track option)					
6731418	68" Low Profile Bucket ♦	\$980.00	24.0%	\$0.00	\$744.80
7184103	68" Snow & Light Material Bucket D	\$1,120.00	24.0%	\$0.00	\$851.20
7184105	74" Snow & Light Material Bucket D	\$1,185.00	24.0%	\$0.00	\$900.60
<b>(T550, T590)</b>					
6731406	68" Constr./Ind. Bucket ♦	\$970.00	24.0%	\$0.00	\$737.20
7124426	68" Constr./Ind. Heavy Duty Bucket ♦	\$1,375.00	24.0%	\$0.00	\$1,045.00
(S530, S570, S590 only) Recommended for severe-duty use					
(Not approved for use with the 55" Farm Grapple P/N 7176977)					
6731409	74" Constr./Ind. Bucket ♦	\$1,050.00	24.0%	\$0.00	\$798.00
(Must also order Side Edge Cutting kit p/n 6732093 when used with wide track option)					
6732305	74" Constr./Ind. Heavy Duty Bucket ♦	\$1,425.00	24.0%	\$0.00	\$1,083.00
(Recommended for severe-duty use)					
(Not approved for use with the 55" Farm Grapple, P/N 7176977)					
6706479	66" Fertilizer & Grain Bucket D	\$1,020.00	24.0%	\$0.00	\$775.20
6706483	72" Fertilizer & Grain Bucket D	\$1,185.00	24.0%	\$0.00	\$900.60
6731418	68" Low Profile Bucket ♦	\$980.00	24.0%	\$0.00	\$744.80
6731421	74" Low Profile Bucket ♦	\$1,065.00	24.0%	\$0.00	\$809.40
(Must also order Side Edge Cutting kit p/n 6732094 when used with wide track option)					
7184103	68" Snow & Light Material Bucket D	\$1,120.00	24.0%	\$0.00	\$851.20
7184105	74" Snow & Light Material Bucket D	\$1,185.00	24.0%	\$0.00	\$900.60
7184110	80" Snow & Light Material Bucket D	\$1,300.00	24.0%	\$0.00	\$988.00
7184098	88" Snow & Light Material Bucket D	\$1,385.00	24.0%	\$0.00	\$1,052.60

**D** Buckets have holes predrilled to accept bolt-on cutting edges.

♦ Buckets have holes predrilled to accept bolt-on cutting edges or bolt-on teeth.

<b>(T630, T650)</b>					
6731409	<b>74" Constr./Ind. Bucket ♦</b> (Must also order Side Edge Cutting kit p/n 6732093 when used with wide track option)	\$1,050.00	24.0%	\$0.00	\$798.00
6732305	<b>74" Constr./Ind. Heavy Duty Bucket ♦</b> (Not approved for use with the 55" Farm Grapple, P/N 7176977)	\$1,425.00	24.0%	\$0.00	\$1,083.00
6731412	<b>80" Constr./Ind. Bucket ♦</b>	\$1,145.00	24.0%	\$0.00	\$870.20
6726344	<b>80" Constr./Ind. Heavy Duty Bucket ♦</b> (Not approved for use with the 55" Farm Grapple, P/N 7176977)	\$1,535.00	24.0%	\$0.00	\$1,166.60
7125917	<b>84" Constr./Ind. Heavy Duty Bucket ♦</b> (Not approved for use with the 55" Farm Grapple, P/N 7176977)	\$1,610.00	24.0%	\$0.00	\$1,223.60
6706483	<b>72" Fertilizer &amp; Grain Bucket D</b> (For use with narrow track only)	\$1,185.00	24.0%	\$0.00	\$900.60
6731421	<b>74" Low Profile Bucket ♦</b> (Must also order Side Edge Cutting kit p/n 6732094 when used with wide track option)	\$1,065.00	24.0%	\$0.00	\$809.40
6731424	<b>80" Low Profile Bucket ♦</b>	\$1,160.00	24.0%	\$0.00	\$881.60
7184105	<b>74" Snow &amp; Light Material Bucket D</b>	\$1,185.00	24.0%	\$0.00	\$900.60
7184110	<b>80" Snow &amp; Light Material Bucket D</b>	\$1,300.00	24.0%	\$0.00	\$988.00
7184098	<b>88" Snow &amp; Light Material Bucket D</b>	\$1,385.00	24.0%	\$0.00	\$1,052.60
<b>(T750, T770)</b>					
6732305	<b>74" Constr./Ind. Heavy Duty Bucket ♦</b> (Not approved for use with the 55" Farm Grapple, P/N 7176977)	\$1,425.00	24.0%	\$0.00	\$1,083.00
6726344	<b>80" Constr./Ind. Heavy Duty Bucket ♦</b> (Not approved for use with the 55" Farm Grapple, P/N 7176977)	\$1,535.00	24.0%	\$0.00	\$1,166.60
7125917	<b>84" Constr./Ind. Heavy Duty Bucket ♦</b> (Not approved for use with the 55" Farm Grapple, P/N 7176977)	\$1,610.00	24.0%	\$0.00	\$1,223.60
6726328	<b>88" Constr./Ind. Heavy Duty Bucket ♦</b> (Not approved for use with the 55" Farm Grapple, P/N 7176977)	\$1,685.00	24.0%	\$0.00	\$1,280.60
7173162	<b>82" Constr./Ind. Severe Duty Bucket ♦</b>	\$1,840.00	24.0%	\$0.00	\$1,398.40
7173161	<b>88" Constr./Ind. Severe Duty Bucket ♦</b>	\$1,975.00	24.0%	\$0.00	\$1,501.00
6706483	<b>72" Fertilizer &amp; Grain Bucket D</b> (For use with narrow track only)	\$1,185.00	24.0%	\$0.00	\$900.60
7184110	<b>80" Snow &amp; Light Material Bucket D</b>	\$1,300.00	24.0%	\$0.00	\$988.00
7184098	<b>88" Snow &amp; Light Material Bucket D</b>	\$1,385.00	24.0%	\$0.00	\$1,052.60
6727787	<b>100" Snow &amp; Light Material Bucket ♦</b>	\$1,805.00	24.0%	\$0.00	\$1,371.80

**D** Buckets have holes predrilled to accept bolt-on cutting edges.

◆ Buckets have holes predrilled to accept bolt-on cutting edges or bolt-on teeth.

(T870) 7125917	<b>84" Constr./Ind. Heavy Duty Bucket ◆</b> (Recommended for severe-duty use) (Not approved for use with the 55" Farm Grapple, P/N 7176977)	\$1,610.00	24.0%	\$0.00	\$1,223.60
6726328	<b>88" Constr./Ind. Heavy Duty Bucket ◆</b> (Recommended for severe-duty use) (Not approved for use with the 55" Farm Grapple, P/N 7176977)	\$1,685.00	24.0%	\$0.00	\$1,280.60
7173161	<b>88" Constr./Ind. Severe Duty Bucket ◆</b> (Recommended for severe-duty use)	\$1,975.00	24.0%	\$0.00	\$1,501.00
7184098	<b>88" Snow &amp; Light Material Bucket D</b>	\$1,385.00	24.0%	\$0.00	\$1,052.60
6727787	<b>100" Snow &amp; Light Material Bucket ◆</b>	\$1,805.00	24.0%	\$0.00	\$1,371.80

D Buckets have holes predrilled to accept bolt-on cutting edges.

◆ Buckets have holes predrilled to accept bolt-on cutting edges or bolt-on teeth.

Part Number	Chipper Description	SLP in US\$	Discount Percent	Labor	Price
-------------	---------------------	-------------	------------------	-------	-------

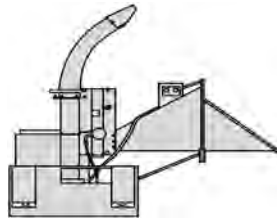

(S450, S510, S550, S530, S570, S590, S220, S250, S300, S330) (A770) (S630, S650, S740, S750, S770, S850) (T450, T550, T590, T250, T300, T320) (T630, T650, T750, T770, T870)	<b>5A Chipper</b> (Loader must be equipped with an Attachment Control Kit) (Attachment includes a 7-pin harness only) (Approved G-Series and newer Loaders only)	\$9,690.00	24.0%	\$0.00	\$7,364.40
(S550H, S570H, S590H, S220H, S250H, S300H, S330H) (A300H) (A770H) (S630H, S650H, S740H, S750H, S770H, S850H) (T550H, T590H, T250H, T300H) (T630H, T650H, T750H, T770H, T870H)	<b>8B Chipper</b> (Loader must be equipped with a 7-Pin Attachment Control Kit) (Approved G Series & New Loaders Only) 5A Chipper must be installed on 700-800 Series BICS Loaders. Will not function on non-BICS loaders, 953s or 963s. 700-800 Series Loaders prior to G-Series need a Remote Attachment Control Kit, P/N 6716566	\$12,190.00	24.0%	\$0.00	\$9,264.40

8B Chipper must be installed on G-Series and new loaders only

Part Number	Combination Bucket Description	SLP in US\$	Discount Percent	Labor	Price
(S70) 6815543	<b>44" Combination Bucket</b> (Bolt-on Teeth are available from Bobcat Dealer)	\$2,295.00	24.0%	\$0.00	\$1,744.20
(S450, S510*, S550*, S530*, S570*) (T450) 7167310	<b>62" Combination Bucket</b> (Bolt-on Teeth are available from Bobcat Dealer)	\$3,040.00	24.0%	\$0.00	\$2,310.40
(S510, S550, S530, S570, S590, S220*, S250*, S300*) (S630*, S650*, S740*, S750*, S770*) (T550, T590) 7167311	<b>68" Combination Bucket</b> (Bolt-on Teeth are available from Bobcat Dealer)	\$3,235.00	24.0%	\$0.00	\$2,458.60
(S510, S550, S530, S570, S590, S220, S250, S300) (S630, S650, S740, S750, S770) (A770) (T550, T590) (T630, T650) 7167312	<b>74" Combination Bucket</b> (Bolt-on Teeth are available from Bobcat Dealer)	\$3,410.00	24.0%	\$0.00	\$2,591.60
(S220, S250, S300, S330) (S630, S650, S740, S750, S770) (A300) (A770) (T250, T300, T320) (T630, T650, T750, T770) 7167313	<b>80" Combination Bucket</b> (Bolt-on Teeth are available from Bobcat Dealer)	\$4,080.00	24.0%	\$0.00	\$3,100.80
(S220, S250, S300, S330) (S740, S750, S770) (A300) (A770) (T250, T300, T320) (T650, T750, T770) 7167314	<b>84" Combination Bucket</b> (Bolt-on Teeth are available from Bobcat Dealer)	\$4,565.00	24.0%	\$0.00	\$3,469.40

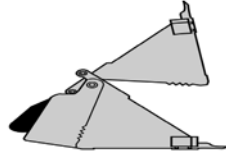

**\*Requires Inset Rims**

Combination Buckets are not approved for use with the Tilt-Tatch.

Combination Buckets may interfere with tracks at extreme roll-back position on some loaders. Use of lift-arm stop is required if this occurs.

It is recommended that a port relief be installed for use with the Combination Buckets. Installation instructions are included in the Operation Manual.

Optional Open/Close Restrictor is available to slow down the open/close functions of the combination bucket.

Part Number	Concrete Mixer Description	SLP in US\$	Discount Percent	Labor	Price
-------------	----------------------------	-------------	------------------	-------	-------

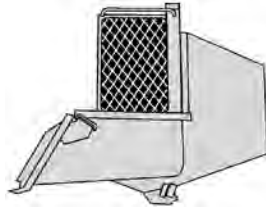

(S450, S510, S550, S530, S570, S590, S630, S650, S740, S750, S770, S850) (S175, S185, S205, S220, S250, S300, S330)

(A770) (T450, T550, T590, T180, T190, T250, T300, T320, T650, T750, T770, T870, T180, T190, T250, T300, T320)

7186695 Concrete Mixer - M-Series Compatible \$4,050.00 24.0% \$0.00 \$3,078.00

(Loader must be equipped with an Attachment Control Kit)

(F-Series and prior Loaders require Remote Attachment Control Kit)

(Attachment includes a 7-Pin Harness only)

Part Number	Concrete Pump Description	SLP in US\$	Discount Percent	Labor	Price
-------------	---------------------------	-------------	------------------	-------	-------

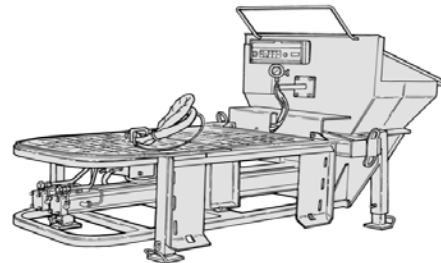

(S570, S570H, S590, S590H, S220, S220H, S250, S250H, S300, S300H, S330, S330H)

(S630, S630H, S650, S650H, S740, S750, S750H, S770, S770H, S850, S850H) (A300, A300H)

(A770, A770H) (T550, T550H, T590, T590H, T250, T250H, T300, T300H, T320, T320H)

(T630, T630H, T650, T650H, T750, T750H, T770, T770H, T870, T870H)

7108693 Concrete Pump \$24,095.00 24.0% \$0.00 \$18,312.20

(Loader must be equipped with an Attachment Control Kit)

(Attachment includes a 7-Pin Harness only)

(May also need Delivery System Kit-unless customer has this equipment)

Concrete Pump needs to be installed on 700-800, S570-S300, A220-A300, T550-T300 G-Series or newer BICS Loaders or 963 G-Series, will not function on F-Series or non-BICS loaders, 953s or 963 C-Series.

Part Number	Accessories Description	SLP in US\$	Discount Percent	Labor	Price
6906079	<b>Delivery System Kit</b> (Includes 5" elbow, 5" to 3" reducer, (3) 25 ft. sections of 3" flexible hose, 3" x 6' flexible hose, (3) 3" x 10' steel lines, (2) 5" couplings, (8) 3" couplings, 3" cleanout ball) (Ship Weight 640 lbs.)	\$4,770.00	24.0%	\$0.00	\$3,625.20
6906813	<b>Remote Control Kit</b> (The hand held transmitter runs all functions of the Concrete Pump within a range of 200-400 feet from the pump.) <i>(Price includes \$90 for installation)</i>	\$1,910.00	24.0%	\$90.00	\$1,541.60

Part Number	Digger Description	SLP in US\$	Discount Percent	Labor	Price
-------------	--------------------	-------------	------------------	-------	-------

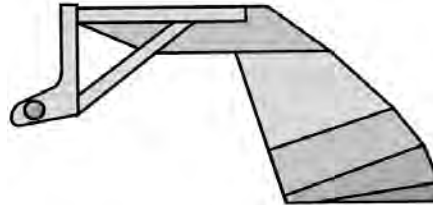

(S70)					
7100915	<b>12S" Digger</b>	\$740.00	24.0%	\$0.00	\$562.40
(S450, S510, S550, S530, S570, S590, S220, S250, S300, S330)					
(S630, S650, S740, S750, S770) (A770) (T450, T550, T590)					
6719756	<b>25" Digger</b>	\$1,020.00	24.0%	\$0.00	\$775.20
6719757	<b>30" Digger</b>	\$1,075.00	24.0%	\$0.00	\$817.00
6719758	<b>36" Digger</b>	\$1,120.00	24.0%	\$0.00	\$851.20



Part Number	Dozer Blade Description	SLP in US\$	Discount Percent	Labor	Price
-------------	-------------------------	-------------	------------------	-------	-------

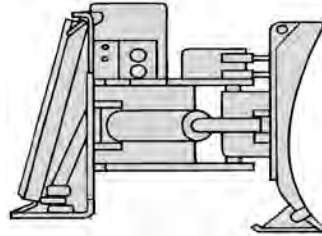

(S70) 7196165	<b>54" Utility Blade (with hydraulic angle)</b> (To be used as either a Snow Blade or a Dozer Blade)	\$1,380.00	24.0%	\$0.00	\$1,048.80
(S450, S510, S550, S530, S570, S590, S220, S250, S300, S330) (S630, S650, S750, S770) (T450, T550, T590) (T630, T650) 6905884	<b>80" Dozer Blade, 6-Way</b> (Loader must be equipped with an Attachment Control Kit) (When used on loaders equipped with a 14-Pin Attachment Control Kit, a 14-Pin Attachment T-Harness Kit is required)	\$4,595.00	24.0%	\$0.00	\$3,492.20
(S220, S250, S300, S330) (S630, S650, S750, S770) (A300) (A770) (T630, T650) 6905811	<b>90" Dozer Blade, 6-Way</b> (Loader must be equipped with an Attachment Control Kit) (When used on loaders equipped with a 14-Pin Attachment Control Kit, a 14-Pin Attachment T-Harness Kit is required)	\$4,960.00	24.0%	\$0.00	\$3,769.60
(S220, S250, S300, S330) (S630, S650, S750, S770, S850) (A300) (A770) (T250, T300, T320) (T630, T650, T750, T770, T870) 7105781	<b>96" Dozer Blade, 6-Way</b> (Loader must be equipped with an Attachment Control Kit) (When used on loaders equipped with a 14-Pin Attachment Control Kit, a 14-Pin Attachment T-Harness Kit is required)	\$6,250.00	24.0%	\$0.00	\$4,750.00

Part Number	Drop Hammer Description	SLP in US\$	Discount Percent	Labor	Price
-------------	-------------------------	-------------	------------------	-------	-------



(S530, S570, S590, S220, S250, S300, S330) (S630, S650, S740, S750, S770, S850) (A300) (A770)  
(T550, T590, T250, T300, T320) (T630, T650, T750, T770, T870)

7137810	Drop Hammer	\$8,120.00	24.0%	\$0.00	\$6,171.20
---------	-------------	------------	-------	--------	------------

Part Number	Dumping Hopper Description	SLP in US\$	Discount Percent	Labor	Price
-------------	----------------------------	-------------	------------------	-------	-------

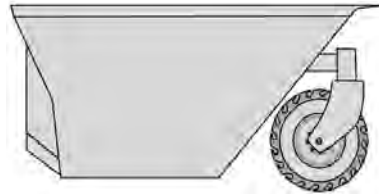

(S70)  
**6727275**                      **Model 10 Dumping Hopper**  
(Includes 8.5 x 12 Bobcat Heavy Duty Tire. Tire is not installed on Dumping Hopper.)  
(For 553, S100 and T110 must also order Mounting Frame P/N 6729483)

		\$2,980.00	24.0%	\$0.00	\$2,264.80
--	--	------------	-------	--------	------------

(S510, S550, S530, S570, S590, S220, S250, S300, S330) (S630, S650, S740, S750, S770, S850)  
(A770) (T450, T550, T590, T250, T300, T320) (T630, T650, T750, T770, T870)

**6717597**                      **Model 25 Dumping Hopper**  
(Includes 8.5 x 12 Bobcat Heavy Duty Tires. Tires are not installed on Dumping Hopper.)

		\$4,610.00	24.0%	\$0.00	\$3,503.60
--	--	------------	-------	--------	------------

Part Number	Flail Cutter Description	SLP in US\$	Discount Percent	Labor	Price
-------------	--------------------------	-------------	------------------	-------	-------

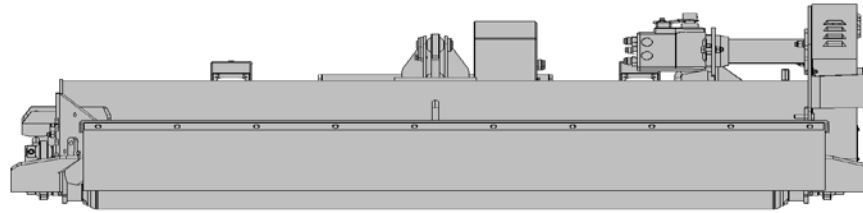

(S530, S530H, S570, S570H, S590, S590H, S220, S220H, S250, S250H, S300, S300H, S330, S330H)(S630, S630H, S650, S650H, S740, S750, S750H, S770, S770H, S850, S850H)  
(A300, A300H)(A770, A770H) (T550, T550H, T590, T590H, T250, T250H, T300, T300H, T320, T320H)(T630, T630H, T650, T650H, T750, T750H, T770, T770H, T870, T870H)  
7101894 FC200 Flail Cutter

\$11,120.00 24.0% \$0.00 \$8,451.20

Part Number	Forestry Cutter Description	SLP in US\$	Discount Percent	Labor	Price
-------------	-----------------------------	-------------	------------------	-------	-------

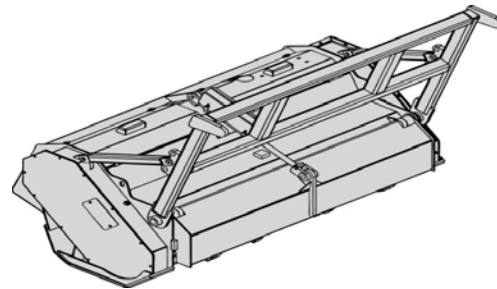

(S300H, S330H) (S750H, S770H, S850H) (A300H) (A770H) (T250H, T300H, T320H) (T750H, T770H, T870H)

7194306

Forestry Cutter, 50"

\$24,470.00 24.0% \$0.00 \$18,597.20

- Must also order Forestry Applications Kit, for K-Series Loaders, p/n 7131810
- For M-Series Loaders (S750H, S770H, S850H, A770H, T750H, T770H, T870H) must order Forestry Apps Kit, PN 7174126
- Loader must be equipped with high flow and certain K-Series SN'd Loaders must be equipped with a upgraded cooling system

(The following K-Series loader serial numbers must be equipped with the cooling system upgrade kit p/n 7126319: A300, SN 539911675 & below; T300 s/n 532015066 & below; T250 s/n 531812826 & below; S300 s/n 531115051 & below) (All S330 Loader are equipped with upgrade cooling system)  
For Certain SN'd A300, S300, S330, T250, T300, T320 Loaders must also order Door Wiring Harness - Will need to provide Serial No of machine

(S300H, S330H) (S750H, S770H, S850H) (A300H) (A770H) (T250H, T300H, T320H)  
(T750H, T770H, T870H)

<b>7194305</b>	<b>Forestry Cutter, 60"</b> <ul style="list-style-type: none"><li>For K-Series Loaders (S300H, S330H, A300H, T250H, T300H, T320H)</li><li>Must also order Forestry Applications Kit, K-Series p/n 7131810</li><li>For M-Series Loaders (S750H, S770H, S850H, A770H, T750H, T770H, T870H)</li></ul> must also order Forestry Applications Kit, M-Series p/n 7174126 <ul style="list-style-type: none"><li>Loader must be equipped with high flow and upgraded cooling system</li></ul>	<b>\$25,730.00</b>	<b>24.0%</b>	<b>\$0.00</b>	<b>\$19,554.80</b>
----------------	---	--------------------	--------------	---------------	--------------------

(The following K-Series loader serial numbers must be equipped with the cooling system upgrade kit p/n 7126319: A300, SN 539911675 & below;  
T300 s/n 532015066 & below; T250 s/n 531812826 & below; S300 s/n 531115051 & below) (All S330 Loader are equipped with upgrade cooling system)  
For Certain SN'd A300, S300, S330, T250, T300, T320 Loaders must also order Door Wiring Harness - Will need to provide Serial No of machine

(S300H, S330H) (S750H, S770H, S850H) (A300H) (A770H) (T250H, T300H, T320H)  
(T750H, T770H, T870H)

<b>7204123</b>	<b>Forestry Cutter, 50" 2 Speed</b> <ul style="list-style-type: none"><li>For K-Series Loaders (S300H, S330H, A300H, T250H, T300H, T320H)</li><li>Must also order Forestry Applications Kit, K-Series p/n 7131810</li><li>For M-Series Loaders (S750H, S770H, S850H, A770H, T750H, T770H, T870H)</li></ul> must also order Forestry Applications Kit, M-Series p/n 7174126 <ul style="list-style-type: none"><li>Loader must be equipped with high flow and upgraded cooling system</li></ul>	<b>\$27,510.00</b>	<b>24.0%</b>	<b>\$0.00</b>	<b>\$20,907.60</b>
----------------	---	--------------------	--------------	---------------	--------------------

(The following K-Series loader serial numbers must be equipped with the cooling system upgrade kit p/n 7126319: A300, SN 539911675 & below;  
T300 s/n 532015066 & below; T250 s/n 531812826 & below; S300 s/n 531115051 & below) (All S330 Loader are equipped with upgrade cooling system)  
For Certain SN'd A300, S300, S330, T250, T300, T320 Loaders must also order Door Wiring Harness - Will need to provide Serial No of machine

(S300H, S330H) (S750H, S770H, S850H) (A300H) (A770H) (T250H, T300H, T320H)  
(T750H, T770H, T870H)

<b>7204127</b>	<b>Forestry Cutter, 60" 2-Speed</b> <ul style="list-style-type: none"><li>For K-Series Loaders (S300H, S330H, A300H, T250H, T300H, T320H)</li><li>Must also order Forestry Applications Kit, K-Series p/n 7131810</li><li>For M-Series Loaders (S750H, S770H, S850H, A770H, T750H, T770H, T870H)</li></ul> must also order Forestry Applications Kit, M-Series p/n 7174126 <ul style="list-style-type: none"><li>Loader must be equipped with high flow and upgraded cooling system</li></ul>	<b>\$28,930.00</b>	<b>24.0%</b>	<b>\$0.00</b>	<b>\$21,986.80</b>
----------------	---	--------------------	--------------	---------------	--------------------

(The following K-Series loader serial numbers must be equipped with the cooling system upgrade kit p/n 7126319: A300, SN 539911675 & below;  
T300 s/n 532015066 & below; T250 s/n 531812826 & below; S300 s/n 531115051 & below) (All S330 Loader are equipped with upgrade cooling system)  
For Certain SN'd A300, S300, S330, T250, T300, T320 Loaders must also order Door Wiring Harness - Will need to provide Serial No of machine

Part Number	Factory Installed Options Description	SLP in US\$	Discount Percent	Labor	Price
7195450	<b>Front Gate, 50''</b> (Produces finer mulch)	\$1,710.00	24.0%	\$0.00	\$1,299.60
7195323	<b>Front Gate, 60''</b> (Produces finer mulch)	\$1,725.00	24.0%	\$0.00	\$1,311.00

Part Number	Factory Installed Options Description	SLP in US\$	Discount Percent	Labor	Price
7230523	<b>Forestry Applications Kit, M-SERIES LOADERS ONLY**</b> <b>Kit is required to operate Forestry Cutter and provides operator &amp; machine protection.</b> <b>**Must also order Engine Seal Kit</b> <b>Not compatible with rear auxiliary hydraulics.</b> Kit includes: Forestry Door (3/4 in. laminated polycarbonate), Front and Rear Light Guards, Hydraulic Quick Coupler Guard, Fire Extinguisher, Level II FOPS, Muffler Guard, Lift Cylinder Debris Shields, Top and Rear Windows, Polycarbonate Side Windows <i>(Add \$900.00 for installation to discounted price)</i>	\$6,170.00	24.0%	\$900.00	\$5,589.20

NOTE: K-Series Loaders must be equipped with PN 7131810 - Forestry Applications Kit - please call for pricing

Part Number	Forks, Utility Description	SLP in US\$	Discount Percent	Labor	Price
-------------	----------------------------	-------------	------------------	-------	-------

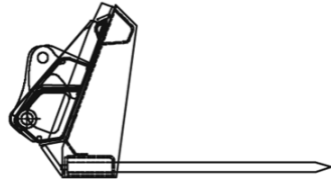

(S70) 6727904	<b>36" Utility fork, with 5 Teeth</b> (Use with Farm/Utility grapple P/N 6728117) (Additional Forks (p/n 6717622) may be Ordered)	\$750.00	24.0%	\$0.00	\$570.00
(S70, S450) (T450) 6727888	<b>54" Utility fork, with 7 Teeth</b> (Use with Farm/Utility grapple P/N 6728117) (Additional Forks (p/n 6717622) may be ordered)	\$895.00	24.0%	\$0.00	\$680.20
(S450, S510, S550, S530, S570, S590) (S630, S650) (T450, T550, T590) 6725178	<b>60" Utility fork, with 8 Teeth</b> (Use with Farm/Utility grapple P/N 7176977) (Additional Forks (p/n 6717622) may be ordered)	\$990.00	24.0%	\$0.00	\$752.40
(S450, S510, S550, S530, S570, S590) (S630, S650) (T450, T550, T590) 6725179	<b>66" Utility fork, with 9 Teeth</b> (Use with Farm/Utility grapple P/N 7176977) (Additional Forks (p/n 6717622) may be ordered)	\$1,090.00	24.0%	\$0.00	\$828.40
(S510, S550, S530, S570, S590, S220, S250, S300, S330) (S630, S650, S740, S750, S770) (A770) (T450, T550, T590) (T630, T650) 6725180	<b>72" Utility fork, with 10 Teeth</b> (Use with Farm/Utility grapple P/N 7176977) (Additional Forks (p/n 6717622) may be ordered)	\$1,235.00	24.0%	\$0.00	\$938.60
(S530, S570, S590, S220, S250, S300, S330) (S630, S650, S740, S750, S770) (A300) (A770) (T550, T590) (T630, T650) 7107243	<b>80" Utility fork, with 11 Teeth</b> (Use with Farm/Utility grapple P/N 7176977) (Additional Forks (p/n 6717622) may be ordered)	\$1,450.00	24.0%	\$0.00	\$1,102.00

Part Number	Grader Description	SLP in US\$	Discount Percent	Labor	Price
-------------	--------------------	-------------	------------------	-------	-------

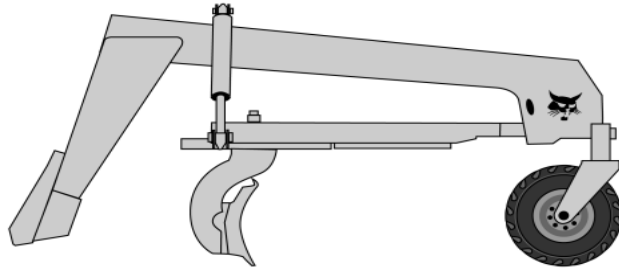

(S450, S510, S550, S530, S570, S590, S220, S250, S300, S330) (S630, S650, S740, S750, S770)  
 (A770) (T450, T550, T590)

6906480	<b>Grader, 84"</b> (Loader must be equipped with an Attachment Control Kit) (When used on loaders equipped with a 14-Pin Attachment Control Kit, a 14-Pin Attachment T-Harness Kit P/N 7164095 is required)	\$8,105.00	24.0%	\$0.00	\$6,159.80
---------	---	------------	-------	--------	------------

(S740, S750, S770, S850) (A770) (T250, T300, T320) (T650, T750, T770, T870)

7160005	<b>Grader,96"</b> (Loader must be equipped with an Attachment Control Kit) (When used on loaders equipped with a 14-Pin Attachment Control Kit, a 14-Pin Attachment T-Harness Kit P/N 7164095 is required)	\$12,920.00	24.0%	\$0.00	\$9,819.20
---------	--	-------------	-------	--------	------------

(S300, S330) (S740, S750, S770, S850) (A770) (T300, T320) (T750, T770, T870)

7182060	<b>Grader, 108"</b> (Loader must be equipped with an Attachment Control Kit) (When used on loaders equipped with a 14-Pin Attachment Control Kit, a 14-Pin Attachment T-Harness Kit P/N 7164095 is required)	\$13,360.00	24.0%	\$0.00	\$10,153.60
---------	--	-------------	-------	--------	-------------

Part Number	Accessories Description	SLP in US\$	Discount Percent	Labor	Price
7164094	<b>Laser Mounting Kit, BLR2 (must also order 2 receivers)</b> (For 84" Grader) (Must also order two laser receivers, p/n 7160486) (Approved for use on Graders S/N 64801631 & above, started production April 2009) (Includes two receiver poles and wiring harnesses) <i>(Price includes \$225 for installation)</i>	\$875.00	24.0%	\$225.00	\$890.00
7177685	<b>Laser Mounting Kit</b> (For 96" and 108" Grader) (Must also order two laser receivers, p/n 7160486) (Includes two receiver poles and wiring harnesses) <i>(Price includes \$225 for installation)</i>	\$915.00	24.0%	\$225.00	\$920.40
7211624	<b>Sonic Tracer and Slope Sensor Mounting Kit</b> (For 96" and 108" Grader) (Must also order Sonic Tracer and Slope Sensor Pkg, PN 7023454) Incs Mounting Brackets, hardware and wiring harnesses (not compatible with end wing kit)	\$1,695.00	24.0%	\$270.00	\$1,558.20
7160486	<b>Laser Receiver, BLR2</b> <b>(Must order 2 for use with laser kit)</b> (May also need a laser transmitter and tripod—unless customer has this equipment.) (The laser receivers will work with most rotating laser transmitters, for full functionality a dual slope-rotating transmitter is recommended.)(Approved for use on Graders S/N 648001631 & above, started production April 2009, and 96" and 108" Graders)	\$1,940.00	24.0%	\$0.00	\$1,474.40
7023454	<b>Sonic Tracer and Slope Sensor Package</b> <b>(Approved for 96" and 108" Graders)</b> (Must also order Sonic Tracer and Slope Mounting Kit, PN 7211624) Incls ST400 Sonic Tracer, AS400 Slope Sensor (qty 2) and RS400 Rotation Sensor (Use where laser transmitters won't work because of obstructions or where grader must follow predetermined slopes and land contours)	\$9,045.00	24.0%	\$0.00	\$6,874.20
7177684	<b>End Wing Kit</b> <b>(Converts graders 96" and 108" into box blade for finish grading only)</b> (Not compatible with the Sonic Tracer)	\$425.00	24.0%	\$90.00	\$413.00
6680073	<b>Laser Transmitter, Dual Slope</b> (Trimble GL722)	\$7,720.00	24.0%	\$0.00	\$5,867.20
6697973	<b>Laser Transmitter, Dual Slope</b> (Trimble GL422; includes CR600 receiver)	\$2,300.00	24.0%	\$0.00	\$1,748.00
6697972	<b>Laser Transmitter, Single Slope</b> (Trimble GL412)	\$1,930.00	24.0%	\$0.00	\$1,466.80
6688806	<b>Tripod</b>	\$240.00	24.0%	\$0.00	\$182.40
Part Number	Grapple, Farm/Utility Description	SLP in US\$	Discount Percent	Labor	Price



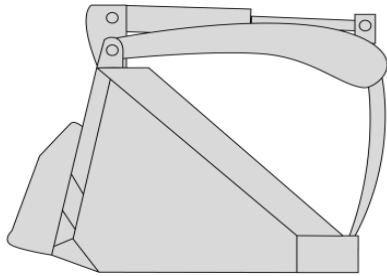

*Farm Grapple with Bucket*

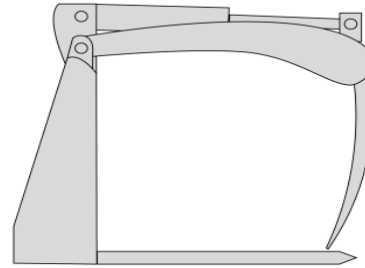

*Farm Grapple with Forks*

(S70) 6728117	<b>Grapple, 32" Utility</b> (Fits Current 36", 48" & 54" Utility Forks) (Price includes \$360 for installation)	<b>\$1,140.00</b>	<b>24.0%</b>	<b>\$360.00</b>	<b>\$1,226.40</b>
7125370	<b>Grapple, 32"</b> (Fits Current 36" – 50" <b>General Purpose</b> buckets) (If bucket is equipped with a 6 hole step, must order a replacement 4 hole step, P/N 7103163) (Price includes \$360 for installation)	<b>\$1,140.00</b>	<b>24.0%</b>	<b>\$360.00</b>	<b>\$1,226.40</b>
(S450, S510, S550, S530, S570, S590, S220, S250, S300, S330) (S630, S650, S740, S750, S770) (A770) (T450, T550, T590) (T630, T650)					
7176977	<b>Grapple, 55" Utility – C/I</b> (Fits 62", 68", 74" and 80" <b>Roundback</b> Low Profile and Construction/Industrial Buckets and 60", 66", 72", and 80" Utility Forks) (Will not fit Heavy Duty Construction/Industrial Buckets) (Price includes \$360 for installation)	<b>\$1,475.00</b>	<b>24.0%</b>	<b>\$360.00</b>	<b>\$1,481.00</b>
(S510, S550, S530, S570)					
7176783	<b>Grapple, 55" Utility - GP</b> (Fits 62", 68" and 74" <b>General Purpose</b> buckets) (Price includes \$360 for installation)	<b>\$1,475.00</b>	<b>24.0%</b>	<b>\$360.00</b>	<b>\$1,481.00</b>

Part Number	Grapple, Industrial Description	SLP in US\$	Discount Percent	Labor	Price
-------------	---------------------------------	-------------	------------------	-------	-------

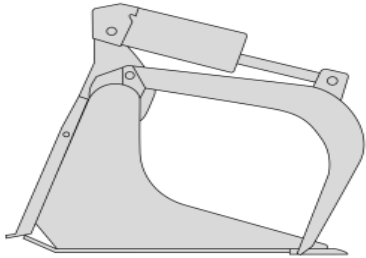

*Industrial Bucket Grapple*

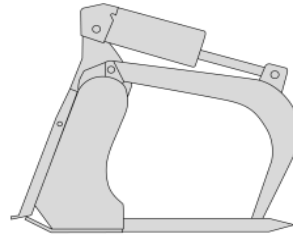

*Industrial Fork Grapple*

(S70) 7135737	<b>36" Industrial Bucket Grapple</b> (Bolt-On Cutting Edge included)	\$1,795.00	24.0%	\$0.00	\$1,364.20
(S100) (T110) 7140888	<b>48" Industrial Bucket Grapple</b> (Bolt-On Cutting Edge included)	\$2,015.00	24.0%	\$0.00	\$1,531.40
(S450, S510, S550, S530, S570, S590) (T450, T550, T590) 7168342	<b>62" Industrial Bucket Grapple</b> (Bolt-On Cutting Edge included)	\$3,215.00	24.0%	\$0.00	\$2,443.40
(S450, S510, S550, S530, S570, S590, S220, S250, S300, S330) (S630, S650, S740, S750, S770) (T450, T550, T590) (T630, T650) 7168340	<b>68" Industrial Bucket Grapple</b> (Bolt-On Cutting Edge included)	\$3,385.00	24.0%	\$0.00	\$2,572.60
(S450, S510, S550, S530, S570, S590, S220, S250, S300) (S630, S650, S740, S750, S770) (T450, T550, T590) (T630, T650) 7168344	<b>66" Industrial Fork Grapple, with 7 teeth</b>	\$3,960.00	24.0%	\$0.00	\$3,009.60
(S630, S650, S740, S750, S770) (A770) (T550, T590) (T630, T650) 7168290	<b>74" Industrial Bucket Grapple</b> (Bolt-On Cutting Edge included)	\$3,585.00	24.0%	\$0.00	\$2,724.60

(S630, S650, S740, S750, S770, S850) (A770)

(T630, T650, T750, T770, T870)

7166624	78" Industrial Fork Grapple, with 8 teeth	\$5,095.00	24.0%	\$0.00	\$3,872.20
---------	---	------------	-------	--------	------------

(S630, S650, S740, S750, S770, S850) (A770)

(T630, T650, T750, T770, T870)

7168339	80" Industrial Bucket Grapple	\$4,895.00	24.0%	\$0.00	\$3,720.20
---------	-------------------------------	------------	-------	--------	------------

(Bolt-On Cutting Edge included)

**It is recommended that a port relief be installed for use with grapples. Installation instructions are included in the Operation Manual.**

**Optional Open/Close Restrictor is available to slow down the open/close functions of the combination bucket.**

Part Number	Grapple, Root Description	SLP in US\$	Discount Percent	Labor	Price
-------------	---------------------------	-------------	------------------	-------	-------

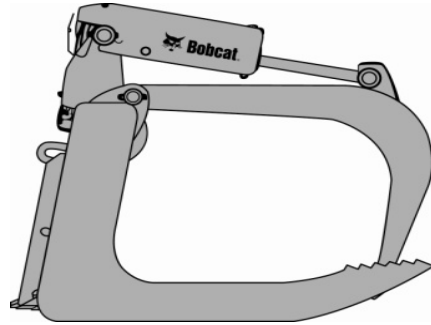

(S70) 7134179	36" Root Grapple	\$1,825.00	24.0%	\$0.00	\$1,387.00
(S100) (T110) 7140902	48" Root Grapple	\$2,150.00	24.0%	\$0.00	\$1,634.00
(S510, S550, S530, S570, S590) (T450, T550, T590) 7168343	66" Root Grapple	\$2,985.00	24.0%	\$0.00	\$2,268.60
(S530, S570, S590, S220, S250, S300, S330) (S630, S650, S740, S750, S770) (A300) (A770) (T550, T590, T250, T300, T320) (T630, T650, T750, T770) 7165486	72" Root Grapple	\$3,290.00	24.0%	\$0.00	\$2,500.40
(S530, S570, S590, S220, S250, S300, S330) (S630, S650, S740, S750, S770, S850) (A300) (A770) (T550, T590, T250, T300, T320) (T630, T650, T750, T770, T870) 7168338	82" Root Grapple	\$3,605.00	24.0%	\$0.00	\$2,739.80

It is recommended that a port relief be installed for use with grapples. Installation instructions are included in the Operation Manual.

Optional Open/Close Restrictor is available to slow down the open/close functions of the combination bucket.

Part Number	Landplane Description	SLP in US\$	Discount Percent	Labor	Price
-------------	-----------------------	-------------	------------------	-------	-------

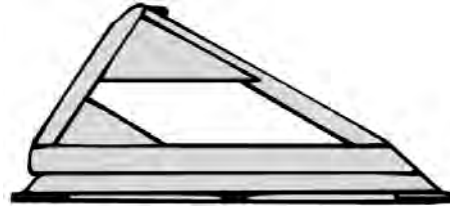

(S70) 6907173	<b>48" Deluxe Landplane Leveling Attachment</b> (Includes expanded metal grate, scarifier assembly, teeth and respective hardware)	\$1,155.00	24.0%	\$0.00	\$877.80
(S450, S510, S550, S530, S570, S590, S220, S250, S300, S330) (S630, S650, S750, S770) (A770) (T450, T550, T590) (T630, T650)					
6906150	<b>72" Deluxe Landplane Leveling Attachment</b> (Includes expanded metal grate, scarifier assembly, teeth and respective hardware)	\$2,000.00	24.0%	\$0.00	\$1,520.00
(S450, S510, S550, S530, S570, S590, S220, S250, S300, S330) (S630, S650, S750, S770) (A770) (T450, T550, T590, T250, T300, T320) (T630, T650, T750, T770)					
6906115	<b>78" Deluxe Landplane Leveling Attachment</b> (Includes expanded metal grate, scarifier assembly, teeth and respective hardware)	\$2,130.00	24.0%	\$0.00	\$1,618.80



Part Number	Mower, Finish Description	SLP in US\$	Discount Percent	Labor	Price
-------------	---------------------------	-------------	------------------	-------	-------

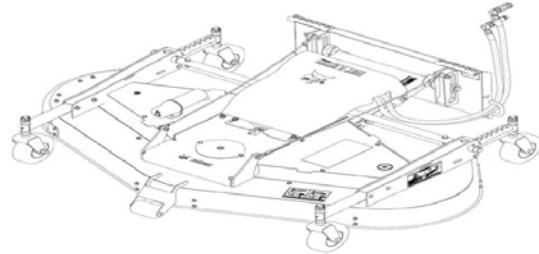

(S450, S510, S550, S530, S570, S590, S220, S250, S300, S330)

(S630, S650, S740, S750, S770)

(A770) (T450, T550, T590, T250, T300, T320) (T630, T650, T750, T770)

7144850	72" Mower	\$4,895.00	24.0%	\$0.00	\$3,720.20
---------	-----------	------------	-------	--------	------------

(S510, S550, S530, S570, S590, S220, S250, S300, S330) (S630, S650, S740, S750, S770, S850)

(A300) (A770) (T550, T590, T250, T300, T320) (T630, T650, T750, T770, T870)

7143993	90" Mower	\$5,355.00	24.0%	\$0.00	\$4,069.80
---------	-----------	------------	-------	--------	------------

Part Number	Packer Wheel Description	SLP in US\$	Discount Percent	Labor	Price
-------------	--------------------------	-------------	------------------	-------	-------

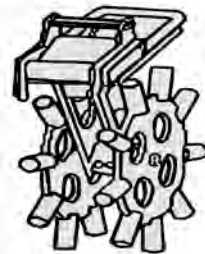

(S450, S510, S530, S550, S570, S590, S630, S650, S740, S750, S770, S850) (A770) (T450, T550, T590)

(T630, T650, T750, T770, T870)

6806644	Packer Wheel	\$2,020.00	24.0%	\$0.00	\$1,535.20
---------	--------------	------------	-------	--------	------------

(Must also order loader x-change mounting frame p/n 7141800)

Part Number	Accessories Description	SLP in US\$	Discount Percent	Labor	Price
-------------	-------------------------	-------------	------------------	-------	-------

<b>7141800</b>	<b>Loader X-Change Mounting Frame</b>	<b>\$985.00</b>	<b>24.0%</b>	<b>\$0.00</b>	<b>\$748.60</b>
----------------	---------------------------------------	-----------------	--------------	---------------	-----------------



Part Number	Pallet Forks Description	SLP in US\$	Discount Percent	Labor	Price
-------------	--------------------------	-------------	------------------	-------	-------

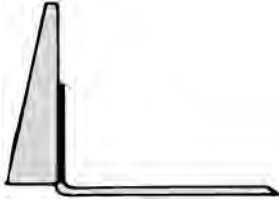

Standard Pallet Fork Teeth and Frame

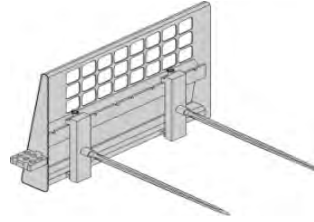

Bale Forks and Frame

(S70) 6809716	Pallet Fork Frame, less teeth	\$425.00	24.0%	\$0.00	\$323.00
6540184	36" Pallet Fork Teeth, Set of 2	\$375.00	24.0%	\$0.00	\$285.00
(S450, S510, S550, S530, S570, S590, S220, S250) (S630, S650) (T450, T550, T590) (T630, T650) 6712927	Pallet Fork Frame, less teeth	\$425.00	24.0%	\$0.00	\$323.00
6815781	<u>Bale Forks</u> Bale Forks, Set of 2	\$610.00	24.0%	\$0.00	\$463.60
6540183	<u>Pallet Forks</u> 42" Pallet Fork Teeth, Set of 2	\$360.00	24.0%	\$0.00	\$273.60
6540182	48" Pallet Fork Teeth, Set of 2	\$380.00	24.0%	\$0.00	\$288.80
(S220, S250, S300, S330) (S630, S650, S740, S750, S770, S850) (T250, T300, T320) (T630, T650, T750, T770, T870) (A300) (A770) 7109332	Pallet Fork Frame, Heavy Duty, less teeth	\$1,150.00	24.0%	\$0.00	\$874.00
6815781	<u>Bale Forks</u> Bale Forks, Set of 2	\$610.00	24.0%	\$0.00	\$463.60
6541521	<u>Pallet Forks</u> 42" Pallet Fork Teeth, Set of 2	\$520.00	24.0%	\$0.00	\$395.20
6541518	48" Pallet Fork Teeth, Set of 2	\$550.00	24.0%	\$0.00	\$418.00

Part	Pallet Forks, Hydraulic	SLP in US\$	Discount	Labor	Price
------	-------------------------	-------------	----------	-------	-------

Number	Description	Percent
--------	-------------	---------

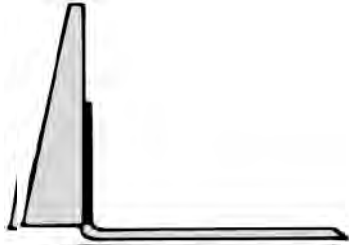

(S450, S510, S550, S530, S570, S590, S220, S250, S300, S330) (A300) (A770)  
(S630, S650, S740, S750, S770, S850)  
(T450, T550, T590, T250, T300, T320) (T630, T650, T750, T770, T870)

6905425	<b>48" Hydraulic Pallet Fork</b> (Includes back frame and 2 hydraulically adjustable 48" teeth)	\$2,900.00	24.0%	\$0.00	\$2,204.00
---------	--	------------	-------	--------	------------

Part Number	Planer Description	SLP in US\$	Discount Percent	Labor	Price
-------------	--------------------	-------------	------------------	-------	-------

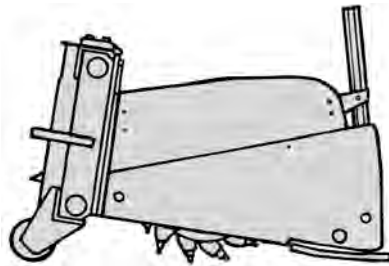

(S450, S510, S550, S530, S570, S590, S220, S250, S300, S330) (S630, S650, S740, S750, S770)  
(A770) (T450, T550, T590, T250, T300, T320) (T630, T650, T750, T770)

M7019	<b>14" Planer, Standard Flow</b> (Includes manual depth adjust, hydraulic sideshift, and hoses) Must also order a drum. (No Attachment Control Kit is required)	\$8,635.00	24.0%	\$0.00	\$6,562.60
-------	---	------------	-------	--------	------------

**Drums for 14" Planers - MUST order one of the following drum options**

M7019-R01-C02	<b>2 1/2" Slot Cut Drum</b> (With 21 bits) (Ship Weight 95 lbs.)	\$1,245.00	24.0%	\$0.00	\$946.20
---------------	---	------------	-------	--------	----------

M7019-R01-C04	<b>4" Slot Cut Drum</b> (With 24 bits) (Ship Weight 111 lbs.)	\$1,380.00	24.0%	\$0.00	\$1,048.80
M7019-R01-C01	<b>6" All Purpose Drum</b> (With 32 bits) (Ship Weight 165 lbs.)	\$1,805.00	24.0%	\$0.00	\$1,371.80
M7019-R01-C05	<b>8" All Purpose Drum</b> (With 34 bits) (Ship Weight 189 lbs.)	\$1,805.00	24.0%	\$0.00	\$1,371.80
M7019-R01-C06	<b>12" All Purpose Drum</b> (With 40 bits) (Ship Weight 245 lbs.)	\$2,255.00	24.0%	\$0.00	\$1,713.80
M7019-R01-C03	<b>14" All Purpose Drum</b> (With 46 bits) (Ship Weight 260 lbs.)	\$2,385.00	24.0%	\$0.00	\$1,812.60

(S550H, S530H, S570H, S590H, S220H, S250H, S300H, S330H)  
(S630H, S650H, S740H, S750H, S770H, S850H) (A300H) (A770H)  
(T550H, T590H, T250H, T300H, T320H) (T630H, T650H, T750H, T770H, T870H)

M7018	<b>18" Planer, High Flow</b> (Includes hydraulic depth adjust, hydraulic sideshift, and hoses) (Must also order drum) (Loader must be equipped with an Attachment Control Kit) (When used on loaders equipped with a 14-Pin Attachment Control Kit , a 14-Pin Attachment T-Harness Kit P/N 7164095 is required)	\$12,770.00	24.0%	\$0.00	\$9,705.20
-------	---	-------------	-------	--------	------------

**Drums for 18" Planers - MUST order one of the following drum options**

M7018-R01-C02	<b>2 ½" Slot Cut Drum</b> (With 21 bits) (Ship Weight 95 lbs.)	\$1,245.00	24.0%	\$0.00	\$946.20
M7018-R01-C05	<b>4" Slot Cut Drum</b> (With 24 bits) (Ship Weight 111 lbs.)	\$1,380.00	24.0%	\$0.00	\$1,048.80
M7018-R01-C01	<b>6" All Purpose Drum</b> (With 32 bits) (Ship Weight 165 lbs.)	\$1,805.00	24.0%	\$0.00	\$1,371.80
M7018-R01-C06	<b>8" All Purpose Drum</b> (With 34 bits) (Ship Weight 189 lbs.)	\$1,805.00	24.0%	\$0.00	\$1,371.80
M7018-R01-C07	<b>12" All Purpose Drum</b> (With 40 bits) (Ship Weight 245 lbs.)	\$2,255.00	24.0%	\$0.00	\$1,713.80
M7018-R01-C03	<b>14" All Purpose Drum</b> (With 46 bits) (Ship Weight 260 lbs.)	\$2,385.00	24.0%	\$0.00	\$1,812.60
M7018-R01-C04	<b>16" Surface Drum</b> (With 84 bits) (Ship Weight 330 lbs.)	\$5,155.00	24.0%	\$0.00	\$3,917.80
M7018-R01-C09	<b>16" Fast Cut All Purpose Drum</b> (With 47 bits) (Ship Weight 266 lbs.)	\$2,965.00	24.0%	\$0.00	\$2,253.40
M7018-R01-C08	<b>16" Smooth Cut All Purpose Drum</b> (With 84 bits) (Ship Weight 322 lbs.)	\$3,740.00	24.0%	\$0.00	\$2,842.40

M7018-R01-C10	<b>18" Fast Cut All Purpose Drum</b> (With 47 bits) (Ship Weight 285 lbs.)	\$3,030.00	24.0%	\$0.00	\$2,302.80
M7018-R01-C11	<b>18" Smooth Cut All Purpose Drum</b> (With 84 bits) (Ship Weight 340 lbs.)	\$3,865.00	24.0%	\$0.00	\$2,937.40
(S530H, S570H, S590H, S220H, S250H, S300H, S330H) (S630H, S650H, S740H, S750H, S770H, S850H) (A300H) (A770H) (T550H, T590H, T250H, T300H, T320H) (T630H, T650H, T750H, T770H, T870H)					
M7017	<b>24" Planer, High Flow</b> (Includes hydraulic depth adjust, hydraulic sideshift, and hoses) (Must also order drum) (Loader must be equipped with an Attachment Control Kit) (When used on loaders equipped with a 14-Pin Attachment Control Kit , a 14-Pin Attachment T-Harness Kit P/N 7164095 is required)	\$15,465.00	24.0%	\$0.00	\$11,753.40
<b><u>Drums for 24" Planers - MUST order one of the following drum options</u></b>					
M7019-R01-C02	<b>2 ½" Slot Cut Drum</b> (With 21 bits) (Ship Weight 95 lbs.)	\$1,245.00	24.0%	\$0.00	\$946.20
M7019-R01-C05	<b>4" Slot Cut Drum</b> (With 24 bits) (Ship Weight 111 lbs.)	\$1,380.00	24.0%	\$0.00	\$1,048.80
M7019-R01-C01	<b>6" All Purpose Drum</b> (With 32 bits) (Ship Weight 165 lbs.)	\$1,805.00	24.0%	\$0.00	\$1,371.80
M7019-R01-C06	<b>8" All Purpose Drum</b> (With 34 bits) (Ship Weight 189 lbs.)	\$1,805.00	24.0%	\$0.00	\$1,371.80
M7019-R01-C07	<b>12" All Purpose Drum</b> (With 40 bits) (Ship Weight 245 lbs.)	\$2,255.00	24.0%	\$0.00	\$1,713.80
M7019-R01-C03	<b>14" All Purpose Drum</b> (With 46 bits) (Ship Weight 260 lbs.)	\$2,385.00	24.0%	\$0.00	\$1,812.60
M7019-R01-C14	<b>16" Surface Drum</b> (With 84 bits) (Ship Weight 330 lbs.)	\$5,155.00	24.0%	\$0.00	\$3,917.80
M7019-R01-C09	<b>16" Fast Cut All Purpose Drum</b> (With 47 bits) (Ship Weight 266 lbs.)	\$2,965.00	24.0%	\$0.00	\$2,253.40
M7019-R01-C08	<b>16" Smooth Cut All Purpose Drum</b> (With 84 bits) (Ship Weight 322 lbs.)	\$3,740.00	24.0%	\$0.00	\$2,842.40
M7019-R01-C10	<b>18" Fast Cut All Purpose Drum</b> (With 47 bits) (Ship Weight 285 lbs.)	\$3,030.00	24.0%	\$0.00	\$2,302.80
M7019-R01-C11	<b>18" Smooth Cut All Purpose Drum</b> (With 84 bits) (Ship Weight 340 lbs.)	\$3,865.00	24.0%	\$0.00	\$2,937.40
M7019-R01-C04	<b>24" Fast Cut All Purpose Drum</b> (With 57 bits) (Ship Weight 375 lbs.)	\$4,105.00	24.0%	\$0.00	\$3,119.80

M7019-R01-C12	<b>24" Smooth Cut All Purpose Drum</b> (With 124 bits) (Ship Weight 420 lbs.)	\$5,155.00	24.0%	\$0.00	\$3,917.80
(S220H, S250H, S300H, S330H) (S630H, S650H, S740H, S750H, S770H, S850H) (A300H) (A770H) (T250H, T300H, T320H) (T630H, T650H, T750H, T770H, T870H)					
6726632	<b>40" Planer, High Flow</b> (Includes hydraulic depth adjust, 40" drum, hydraulic sideshift, hydraulic oscillation & hoses) (Loader must be equipped with an Attachment Control Kit) (When used on loaders equipped with a 14-Pin Attachment Control Kit, a 14-Pin Attachment T-Harness Kit is required)	\$25,760.00	24.0%	\$0.00	\$19,577.60

Part Number	Rock Bucket Description	SLP in US\$	Discount Percent	Labor	Price
-------------	-------------------------	-------------	------------------	-------	-------

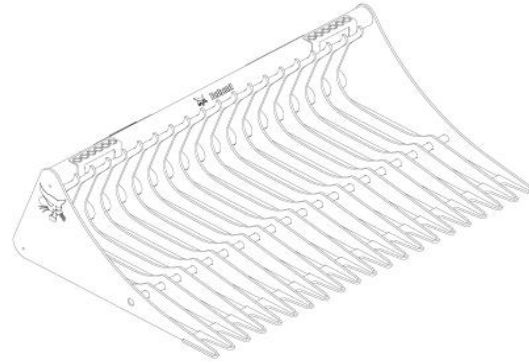

(S450, S510, S550, S530, S570, S590, S220, S250, S300, S330) (S630, S650) (A300)  
(T450, T550, T590, T250, T300, T320) (T630, T650)

7185941                      62" Rock Bucket    \$1,330.00              24.0%              \$0.00              \$1,010.80

(S450, S510, S550, S530, S570, S590, S220, S250, S300, S330) (S630, S650, S740, S750, S770) (A300)  
T450, T550, T590, T250, T300, T320) (T630, T650)

7185943                      68" Rock Bucket    \$1,450.00              24.0%              \$0.00              \$1,102.00

(S630, S650, S740, S750, S770, S850) (A770) (T250, T300, T320)  
(T630, T650, T750, T770, T870)

7185945                      74" Rock Bucket    \$1,510.00              24.0%              \$0.00              \$1,147.60

(S630, S650, S740, S750, S770, S850) (A770) (T250, T300, T320)  
(T630, T650, T750, T770, T870)

7185947                      82" Rock Bucket    \$1,650.00              24.0%              \$0.00              \$1,254.00

Bobcat Rock Buckets work excellent for separating unwanted objects, such as rocks and other debris, from work areas while leaving finer material behind that can be cultivated or landscaped. Each tine tip is fully gusseted on each side, and connected to the tip next to it. This allows the Bobcat Rock Bucket to be used effectively as a tool to clear the soil surface of vegetation or other debris, as well as to be used to pull up objects from below the ground surface.

Part Number	Scarifier Description	SLP in US\$	Discount Percent	Labor	Price
-------------	-----------------------	-------------	------------------	-------	-------

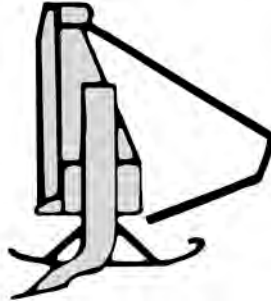

(S450, S510, S550, S530, S570, S590, S220, S250, S300, S330) (S630, S650, S740, S750, S770)  
 (A770) (T450, T140, T550, T590) (T630, T650)

6563526	Front Scarifier (Includes 2 Depth Guides and 5 Teeth)	\$1,175.00	24.0%	\$0.00	\$893.00
---------	--	------------	-------	--------	----------

Part Number	Scraper Description	SLP in US\$	Discount Percent	Labor	Price
-------------	---------------------	-------------	------------------	-------	-------

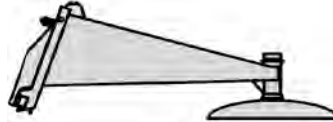

(S450, S510, S550, S530, S570, S590, S220, S250, S300, S330)  
 (S630, S650, S740, S750, S770) (A770) (T450, T550, T590, T250, T300, T320)  
 (T630, T650, T750, T770)

6675211	Scraper	\$1,130.00	24.0%	\$0.00	\$858.80
---------	---------	------------	-------	--------	----------

Part Number	Seeder Description	SLP in US\$	Discount Percent	Labor	Price
-------------	--------------------	-------------	------------------	-------	-------

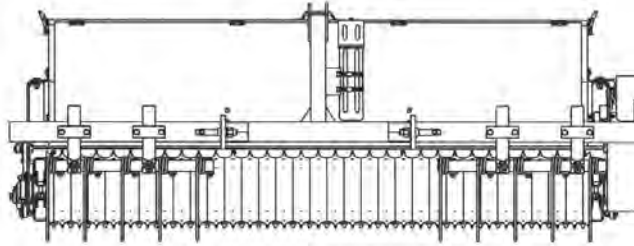

(S450, S510, S550, S530, S570, S590, S220, S250, S300, S330) (S630, S650, S740, S750, S770)  
 (A770) (T450, T550, T590, T250, T300, T320) (T630, T650, T750, T770)

7167712	Seeder, 72", 3PT Mounting (Must also order Bob-Tach adapter)	\$6,720.00	24.0%	\$0.00	\$5,107.20
---------	---	------------	-------	--------	------------

Part Number	Factory Installed Options Description	SLP in US\$	Discount Percent	Labor	Price
-------------	---------------------------------------	-------------	------------------	-------	-------

7167758	Bob-Tach Adapter (Allows Seeder to mount on Bob-Tach equipped machines)	\$665.00	24.0%	\$0.00	\$505.40
---------	--	----------	-------	--------	----------



Part Number	Silt Fence Installer Description	SLP in US\$	Discount Percent	Labor	Price
-------------	----------------------------------	-------------	------------------	-------	-------

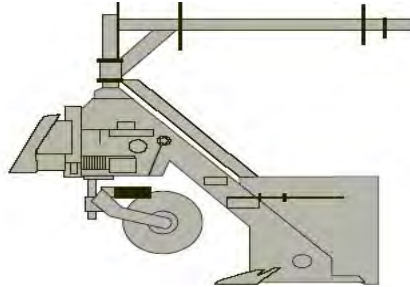

S220, S250, S300, S330) (S630, S650, S740, S750, S770, S850) (A300) (A770)  
(T550, T590, T250, T300, T320) (T630, T650, T750, T770, T870)

7137320	<b>Silt Fence Installer</b> (Must also order mounting frame)	\$4,740.00	24.0%	\$0.00	\$3,602.40
---------	---	------------	-------	--------	------------

Part Number	Factory Installed Options Description	SLP in US\$	Discount Percent	Labor	Price
-------------	---------------------------------------	-------------	------------------	-------	-------

7137333	<b>Loader Rigid Mounting Frame</b>	\$1,160.00	24.0%	\$0.00	\$881.60
7139171	<b>3-Point Rigid Mounting Frame</b> (Must also order Adapter p/n 7137334)	\$1,140.00	24.0%	\$0.00	\$866.40
7137332	<b>3-Point Mounting Frame, 72" Side-Shift</b> (Must also order Adapter p/n 7137334)	\$2,270.00	24.0%	\$0.00	\$1,725.20
7137331	<b>3-Point Mounting Frame, 84" Side-Shift</b> (Must also order Adapter p/n 7137334)	\$2,395.00	24.0%	\$0.00	\$1,820.20

Part Number	Snow Blade Description	SLP in US\$	Discount Percent	Labor	Price
-------------	------------------------	-------------	------------------	-------	-------

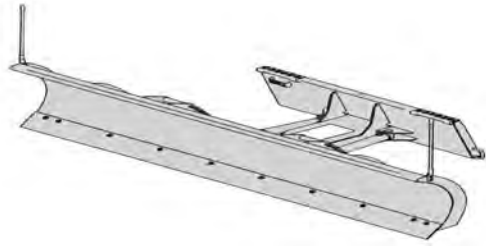

(S70) 7196165	<b>54" Utility Blade (with hydraulic angle)</b> (To be used as either a Snow Blade or a Dozer Blade)	\$1,380.00	24.0%	\$0.00	\$1,048.80
(S450, S510, S550) (T450) 6906107	<b>60" Snow Blade (with hydraulic angle)</b>	\$2,000.00	24.0%	\$0.00	\$1,520.00
(S450, S510, S550, S530, S570, S590) (S630, S650) (T450) 6905156	<b>72" Snow Blade (with hydraulic angle)</b>	\$2,160.00	24.0%	\$0.00	\$1,641.60
(S450, S510, S550, S530, S570, S590, S220, S250, S300) (S630, S650, S740, S750, S770) (T450) (A770) 6716836	<b>84" Snow Blade (with hydraulic angle)</b>	\$2,355.00	24.0%	\$0.00	\$1,789.80
(S630, S650, S740, S750, S770) (A770) (T450) 6716838	<b>96" Snow Blade (with hydraulic angle)</b>	\$2,450.00	24.0%	\$0.00	\$1,862.00
(S510, S550, S530, S570, S590, S220) (S630, S650) (T450, T550, T590) (T630, T650) 7207861	<b>86" Snow Blade – Heavy Duty (with hydraulic angle)</b>	\$3,715.00	24.0%	\$0.00	\$2,823.40
(S510, S550, S530, S570, S590, S220, S250, S300, S330) (S630, S650, S740, S750, S770) (A770) (T450, T550, T590, T250, T300, T320) (T630, T650, T750, T770) 7207862	<b>96" Snow Blade – Heavy Duty (with hydraulic angle)</b>	\$3,809.00	24.0%	\$0.00	\$2,894.84
(S510, S550, S530, S570, S590, S220, S250, S300, S330) (S630, S650, S740, S750, S770, S850) (A300) (A770) (T550, T590, T250, T300, T320) (T630, T650, T750, T770, T870) 7207863	<b>108" Snow Blade – Heavy Duty (with hydraulic angle)</b>	\$4,168.00	24.0%	\$0.00	\$3,167.68

Part Number	Snow Pusher Description	SLP in US\$	Discount Percent	Labor	Price
-------------	-------------------------	-------------	------------------	-------	-------

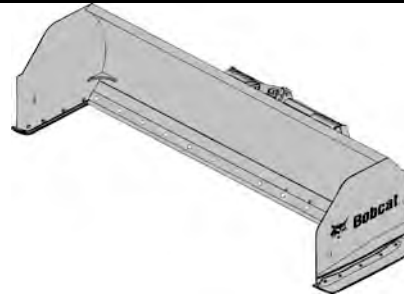

(S450,510, S550, S530, S570, S590, S220, S250, S300, S330) (S630, S650, S740, S750, S770, S850) (A770) (T450, T550, T590, T250, T300, T320) (T630, T650, T750, T770, T870)					
7113767	Snow Pusher, 8'	\$3,095.00	24.0%	\$0.00	\$2,352.20
(S590, S220, S250, S300, S330) (S630, S650, S740, S750, S770, S850) (A300) (A770) (T550, T590, T250, T300, T320) (T630, T650, T750, T770, T870)					
7116164	Snow Pusher, 10'	\$3,405.00	24.0%	\$0.00	\$2,587.80

Part Number	Snow V-Blade Description	SLP in US\$	Discount Percent	Labor	Price
-------------	--------------------------	-------------	------------------	-------	-------



Blade in "V" Configuration

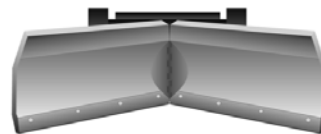

Blade in "Scoop" Configuration

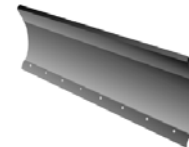

Blade in "Angled" Configuration

(S450, S510, S550, S530, S570, S590) (T450)					
7104861	60" Snow V-Blade, 7-Pin (Loader must be equipped with an Attachment Control Kit) Blade is equipped with fingertip 7-Pin Control. Adjustable blade width from 53-60 inches.	\$3,895.00	24.0%	\$0.00	\$2,960.20
(S450, S510, S550, S530, S570, S590) (T450, T550, T590)					
6958576	72" Snow V-Blade (Loader must be equipped with an Attachment Control Kit) (When used on loaders	\$4,160.00	24.0%	\$0.00	\$3,161.60

equipped with a 14-Pin Attachment Control Kit a 14-Pin Attachment T-Harness Kit  
(P/N 6725383) is required)

(S450, S510, S550, S530, S570, S590, S220, S250, S300, S330) (S630, S650, S740, S750, S770)  
(A770) (T450, T550, T590, T250, T300, T320) (T630, T650, T750, T770)

**6958577**      **84" Snow V-Blade**      **\$4,255.00**      **24.0%**      **\$0.00**      **\$3,233.80**  
(Loader must be equipped with an Attachment Control Kit) (When used on loaders  
equipped with a 14-Pin Attachment Control Kit a 14-Pin Attachment T-Harness Kit  
(P/N 6725383) is required)

(S530, S570, S590, S220, S250, S300, S330) (S630, S650, S740, S750, S770) (A300) (A770)  
(T550, T590, T250, T300, T320) (T630, T650, T750, T770)

**6958578**      **96" Snow V-Blade**      **\$4,350.00**      **24.0%**      **\$0.00**      **\$3,306.00**  
(Loader must be equipped with an Attachment Control Kit) (When used on loaders  
equipped with a 14-Pin Attachment Control Kit a 14-Pin Attachment T-Harness Kit  
(P/N 6725383) is required)

(S220, S250, S300, S330) (S630, S650, S740, S750, S770) (A300) (A770)  
(T250, T300, T320) (T630, T650, T750, T770)

**6958579**      **108" Snow V-Blade**      **\$4,445.00**      **24.0%**      **\$0.00**      **\$3,378.20**  
(Loader must be equipped with an Attachment Control Kit) (When used on loaders  
equipped with a 14-Pin Attachment Control Kit a 14-Pin Attachment T-Harness Kit  
(P/N 6725383) is required)

Part Number	Accessories Description	SLP in US\$	Discount Percent	Labor	Price
-------------	-------------------------	-------------	------------------	-------	-------

**7102606**      **Blade Flotation Option**      **\$835.00**      **24.0%**      **\$0.00**      **\$634.60**  
(Allows blade to oscillate +/- 10 degrees, includes pin to lock in place at 0 degrees)  
(Approved for use with 72", 84", 96" and 108" Snow V-Blades)  
(The frame flotation mounts between the existing frame and blade and will extend the  
overall blade length eight-inches from the Bob-Tach.)

Part Number	Snowblower Description	SLP in US\$	Discount Percent	Labor	Price
-------------	------------------------	-------------	------------------	-------	-------

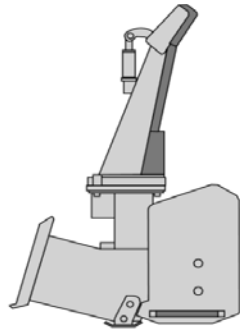

Part Number	SB150 Snowblower Description	SLP in US\$	Discount Percent	Labor	Price
-------------	------------------------------	-------------	------------------	-------	-------

(S70)

M7007	<b>SB150 x 36"</b> (Loader must be equipped with a Bobcat 14-Pin Attachment Control Kit) (Snowblower includes hydraulic motor package)	\$4,380.00	24.0%	\$0.00	\$3,328.80
-------	--	------------	-------	--------	------------

(S70, S100) (T110)

M7008	<b>SB150 x 48"</b> (Loader must be equipped with a Bobcat 14-Pin Attachment Control Kit) (Snowblower includes hydraulic motor package)	\$4,525.00	24.0%	\$0.00	\$3,439.00
-------	--	------------	-------	--------	------------

Part Number	SB200 Snowblower Description	SLP in US\$	Discount Percent	Labor	Price
-------------	------------------------------	-------------	------------------	-------	-------

**Preferred Hydraulic Motor Package (BOLD)**

*Must order a hydraulic motor package with the SB200 & SB240 Snowblowers*

*Loader must be equipped with a 7-pin Attachment Control Kit*

(S450\*, S510\*, S550\*, S550H\*, S530\*, S570\*, S570H\*) (T450)

M7001	<b>SB200 x 60" Snowblower</b>	\$4,295.00	24.0%	\$0.00	\$3,264.20
M7001-R01-C01	5.5 Hydraulic Motor Package (S450, S510*, S550*, S530*, S570*) (T450)	\$1,065.00	24.0%	\$0.00	\$809.40
M7001-R01-C02	6.2 Hydraulic Motor Package (S450, S510*, S550*, S530*, S570*) (T450)	\$1,065.00	24.0%	\$0.00	\$809.40
M7001-R01-C03	8.0 Hydraulic Motor Package (S550H*, S570H*)	\$1,125.00	24.0%	\$0.00	\$855.00
M7001-R01-C04	9.6 Hydraulic Motor Package	\$1,190.00	24.0%	\$0.00	\$904.40

(S550H\*, S570H\*)

(S450, S510, S550, S550H, S530, S570, S570H, S590, S590H, S250\*, S300\*)

(S630\*, S630H\*, S650\*, S650H\*, S740\*, S750\*, S770\*) (T450, T550, T550H, T590, T590H)

<b>M7002</b>	<b>SB200 x 66" Snowblower</b>	<b>\$4,430.00</b>	<b>24.0%</b>	<b>\$0.00</b>	<b>\$3,366.80</b>
M7002-R01-C01	5.5 Hydraulic Motor Package (S450, S510, S550, S530, S570, S590) (T450, T550, T590)	\$1,065.00	24.0%	\$0.00	\$809.40
M7002-R01-C02	6.2 Hydraulic Motor Package (S450, S510, S550, S530, S570, S590, S250*, S300*) (T450, T550, T590)	\$1,065.00	24.0%	\$0.00	\$809.40
M7002-R01-C03	8.0 Hydraulic Motor Package (S630*, S650*, S750*, S770*) (S550H, S570H, S590H) (T550H, T590H)	\$1,125.00	24.0%	\$0.00	\$855.00
M7002-R01-C04	9.6 Hydraulic Motor Package (S550H, S570H, S590H, S630H*, S650H*) (T550H, T590H)	\$1,190.00	24.0%	\$0.00	\$904.40

**\*Offset rims required**

**Preferred Hydraulic Motor Package (BOLD)**

*Must order a hydraulic motor package with the SB200 Snowblowers*

*Loader must be equipped with a 7-pin Attachment Control Kit*

(S450, S510, S550, S550H, S530, S570, S570H, S590, S590H, S250, S300, S330)

(S630, S630H, S650, S650H, S740, S750, S770) (A770) (T450, T550, T550H, T590, T590H)

(T630, T630H, T650, T650H, T750\*, T770\*)

<b>M7003</b>	<b>SB200 x 72" Snowblower</b>	<b>\$4,575.00</b>	<b>24.0%</b>	<b>\$0.00</b>	<b>\$3,477.00</b>
M7003-R01-C01	5.5 Hydraulic Motor Package (S450, S510, S550, S530, S570, S590) (T450, T550, T590)	\$1,065.00	24.0%	\$0.00	\$809.40
M7003-R01-C02	6.2 Hydraulic Motor Package (S450, S510, S550, S530, S570, S590, S250, S300, S330) (T450, T550, T590)	\$1,065.00	24.0%	\$0.00	\$809.40
M7003-R01-C03	8.0 Hydraulic Motor Package (S630, S650, S740, S750, S770) (A770) (T630, T650, T750*, T770*) (S550H, S570H, S590H) (T550H, T590H)	\$1,125.00	24.0%	\$0.00	\$855.00
M7003-R01-C04	9.6 Hydraulic Motor Package (S550H, S570H, S590H, S630H, S650H) (T550H, T590H, T630H, T650H)	\$1,190.00	24.0%	\$0.00	\$904.40

(S510, S550, S550H, S530, S570, S570H, S590, S590H, S250, S300, S330)

(S630, S630H, S650, S650H, S740, S750, S770, S850) (A300) (A770)

(T550, T550H, T590, T590H, T300, T320) (T630, T630H, T650, T650H, T750, T770)					
<b>M7004</b>	<b>SB200 x 78" Snowblower</b>	<b>\$4,850.00</b>	<b>24.0%</b>	<b>\$0.00</b>	<b>\$3,686.00</b>
M7004-R01-C02	6.2 Hydraulic Motor Package (S510, S550, S530, S570, S590, S250, S300, S330) (T550, T590, T300, T320) (A300)	\$1,065.00	24.0%	\$0.00	\$809.40
M7004-R01-C03	8.0 Hydraulic Motor Package (S630, S650, S740, S750, S770, S850) (A770) (T630, T650, T750, T770) (S550H, S570H, S590H) (T550H, T590H)	\$1,125.00	24.0%	\$0.00	\$855.00
M7004-R01-C04	9.6 Hydraulic Motor Package (S550H, S570H, S590H, S630H, S650H) (T550H, T590H, T630H, T650H)	\$1,190.00	24.0%	\$0.00	\$904.40

Part Number	SB240 Snowblower Description	SLP in US\$	Discount Percent	Labor	Price
-------------	------------------------------	-------------	------------------	-------	-------

**Preferred Hydraulic Motor Package (BOLD)**  
*Must order a hydraulic motor package with the SB240 Snowblowers & 7 pin attachment control*

(S550H, S570H, S590H) (S630H, S650H, S740, S750, S770) (A770) (T550H, T590H) (T630H, T650H, T750*, T770*)					
<b>M7005</b>	<b>SB240 x 72" Snowblower</b>	<b>\$6,120.00</b>	<b>24.0%</b>	<b>\$0.00</b>	<b>\$4,651.20</b>
M7005-R01-C03	8.0 Hydraulic Motor Package (S750, S770) (A770) (T750*, T770*) (S550H, S570H, S590H) (T550H, T590H)	\$1,125.00	24.0%	\$0.00	\$855.00
M7005-R01-C04	9.6 Hydraulic Motor Package (S550H, S570H, S590H, S630H, S650H) (T550H, T590H, T630H, T650H) * Narrow Track Option Required	\$1,190.00	24.0%	\$0.00	\$904.40

**Preferred Hydraulic Motor Package (BOLD)**  
*Must order a hydraulic motor package with the SB240 Snowblowers & 7 pin attachment control*

(S630H, S650H, S740, S750, S770, S850) (A770) (T550H, T590H) (T630H, T650H, T750, T770, T870)					
<b>M7006</b>	<b>SB240 x 84" Snowblower</b>	<b>\$6,250.00</b>	<b>24.0%</b>	<b>\$0.00</b>	<b>\$4,750.00</b>
M7006-R01-C03	8.0 Hydraulic Motor Package (S740, S750, S770, S850) (A770) (T750, T770, T870) (T550H, T590H)	\$1,125.00	24.0%	\$0.00	\$855.00
M7006-R01-C04	9.6 Hydraulic Motor Package (S630H, S650H) (T550H, T590H, T630H, T650H)	\$1,190.00	24.0%	\$0.00	\$904.40

Part	SBX240 Snowblower	SLP in US\$	Discount	Labor	Price
------	-------------------	-------------	----------	-------	-------

Number	Description	Percent			
--------	-------------	---------	--	--	--

*Approved for use with loaders equipped with 37 GPM high flow only*

**(S550H, S570H, S590H, S630H, S650H, S250H, S300H, S330H) (S740H, S750H, S770H) (A300H) (A770H) (T300H, T320H) (T750H, T770H)**

<b>M7009</b>	<b>SBX240 x 72"</b> (Approved for use with loaders equipped with high flow: S220 s/n 526214400 & above; S250 s/n 5260167000 & above; S300 s/n 525815600 & above; T250 s/n 525613400 & above T300 s/n 525414500 & above; A300 s/n 526412200 & above) (Snowblower includes hydraulic motor package)	<b>\$7,830.00</b>	<b>24.0%</b>	<b>\$0.00</b>	<b>\$5,950.80</b>
--------------	---	-------------------	--------------	---------------	-------------------

**(S250H, S300H, S330H) (S740H, S750H, S770H, S850H) (A300H) (A770H) (T300H, T320H) (T750H, T770H, T870H)**

<b>M7010</b>	<b>SBX240 x 84" (blower includes hyd motor pkg)</b> (Approved for use with loaders equipped with high flow: S220 s/n 526214400 & above; S250 s/n 5260167000 & above; S300 s/n 525815600 & above; T250 s/n 525613400 & above; T300 s/n 525414500 & above; A300 s/n 526412200 & above)	<b>\$7,975.00</b>	<b>24.0%</b>	<b>\$0.00</b>	<b>\$6,061.00</b>
--------------	---	-------------------	--------------	---------------	-------------------



Part Number	Accessories Description	SLP in US\$	Discount Percent	Labor	Price
6958978	<b>Truck Loading Chute</b> (For SB240 and SBX240 Snowblowers, will not fit SB200) (For use with high flow loaders only) (Includes deflector control, support mount and hoses) (Price includes \$270 for installation)	\$1,460.00	24.0%	\$270.00	\$1,379.60

Part Number	Sod Layer Description	SLP in US\$	Discount Percent	Labor	Price
-------------	-----------------------	-------------	------------------	-------	-------

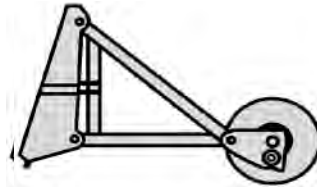

(S450, S510, S550, S530, S570, S590, S220, S250, S300, S330)  
 (S630, S650, S750, S770, S850)  
 (A770) (T450, T550, T590, T250, T300, T320) (T630, T650, T750, T770, T870)

6906783	Sod Layer	\$3,720.00	24.0%	\$0.00	\$2,827.20
---------	-----------	------------	-------	--------	------------

Part Number	Soil Conditioner Description	SLP in US\$	Discount Percent	Labor	Price
-------------	------------------------------	-------------	------------------	-------	-------

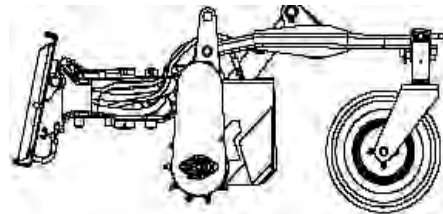

(463, S70, 553, S100) (T110)

6958310	48" Soil Conditioner, Manual Angle	\$6,100.00	24.0%	\$0.00	\$4,636.00
---------	------------------------------------	------------	-------	--------	------------

(S450, S510, S550, S550H, S530, S570, S570H, S590, S590H, S220, S220H, S250, S250H,  
 S300, S300H, S330, S330H) (S630, S630H, S650, S650H, S740, S750, S750H, S770, S770H)

(A770, A770H) (T450, T550, T550H, T590, T590H)					
(T630, T630H, T650, T650H)					
6906513	72" Soil Conditioner, Manual Angle	\$8,000.00	24.0%	\$0.00	\$6,080.00
7135945	72" Soil Conditioner, Hydraulic Angle and Depth (Loader must be equipped with an Attachment Control Kit)	\$8,690.00	24.0%	\$0.00	\$6,604.40
(S550H, S570H, S590H, S220H, S250H, S300H, S330H) (S630H, S650H, S740H, S750H, S770H)					
(A300H) (A770H) (T550H, T590H, T250H, T300H, T320H)					
(T630H, T650H, T750H, T770H)					
7135944	72" Soil Conditioner, High Flow Hydraulic Angle and Depth (Loader must be equipped with an Attachment Control Kit)	\$8,990.00	24.0%	\$0.00	\$6,832.40
(S530, S570, S570H, S590, S590H, S220, S220H, S250, S250H, S300, S300H, S330, S330H)					
(S630, S630H, S650, S650H, S740, S750, S750H, S770, S770H, S850)					
(A300, A300H) (A770, A770H)					
(T550, T550H, T590, T590H, T250, T250H, T300, T300H, T320, T320H)					
(T630, T630H, T650, T650H, T750, T750H, T770, T770H, T870)					
7135946	84" Soil Conditioner, Hydraulic Angle and depth (Loader must be equipped with an Attachment Control Kit)	\$9,190.00	24.0%	\$0.00	\$6,984.40
(S220H, S250H, S300H, S330H) (S630H, S650H, S740H, S750H, S770H, S850H) (A300H)					
(A770H)(T250H, T300H, T320H) (T630H, T650H, T750H, T770H, T870H)					
7135947	84" Soil Conditioner, High Flow Hydraulic Angle and Depth (Loader must be equipped with an Attachment Control Kit)	\$9,590.00	24.0%	\$0.00	\$7,288.40

Part Number	Spreader Description	SLP in US\$	Discount Percent	Labor	Price
-------------	----------------------	-------------	------------------	-------	-------

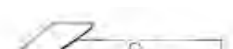

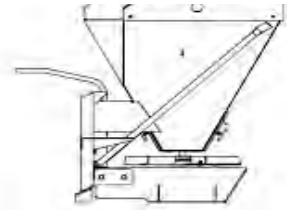

(S450, S510, S550, S530, S570, S590, S220, S250, S300, S330)  
 (S630, S650, S740, S750, S770, S850) (A300) (A770)  
 (T450, T550, T590, T250, T300, T320) (T630, T650, T750, T770, T870)  
**7157284 HS8 Spreader**

**\$3,355.00 24.0% \$0.00 \$2,549.80**

Part Number	Stabilizer Description	SLP in US\$	Discount Percent	Labor	Price
-------------	------------------------	-------------	------------------	-------	-------

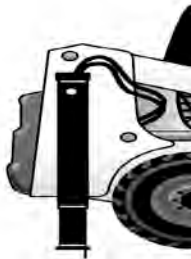

(S510, S550, S530, S570, S590) (S630, S650, S740, S750, S770, S850)  
 (A770) (T550, T590) (T630, T650, T750, T770, T870)  
**6811449 Quick-Tach Rear Stabilizer Kit**

**\$1,395.00 24.0% \$270.00 \$1,330.20**

(Must also order mounting kit)  
 (Intended for use with 607, 709, 8811 Backhoes, Augers and Tree Spades)  
 (Rear Stabilizers NOT compatible with Bob-Tach Mounted Backhoe P/N 6906767)  
 (Price includes \$270 for installation)

Part Number	Accessories Description	SLP in US\$	Discount Percent	Labor	Price
-------------	-------------------------	-------------	------------------	-------	-------

(S510, S550, S530, S570, S590) (T550, T590) (S630, S650) (T630, T650)  
**7152508 Mounting Kit**

**\$440.00 24.0% \$0.00 \$334.40**

(Approved for use with M-Series Loaders to mount Quick-Tach Stabilizer and

Quick-Tach Water Kit) (Ship weight 120 lbs.)

(S740, S750, S770, S850) (A770) (T750, T770, T870)

<b>7152512</b>	<b>Mounting Kit</b> (Approved for use with M-Series Loaders to mount Quick-Tach Stabilizer and Quick-Tach Water Kit) (Ship weight 90 lbs.)	<b>\$440.00</b>	<b>24.0%</b>	<b>\$0.00</b>	<b>\$334.40</b>
----------------	---	-----------------	--------------	---------------	-----------------

Part Number	Steel Tracks Description	SLP in US\$	Discount Percent	Labor	Price
-------------	--------------------------	-------------	------------------	-------	-------



**Complete Track Package**

*Each part number includes a set of tracks, web binder, hardware, and if required, wheel spacers and lift arm stops.*

(S510, S530, S550, S570, S590)

<b>7222581</b>	<b>10.00-16.5 (72" loader width)</b> (Order PN 7233132 if loader is equipped with 31-12-16.5 tires)	<b>\$3,215.00</b>	<b>24.0%</b>	<b>\$0.00</b>	<b>\$2,443.40</b>
----------------	--	-------------------	--------------	---------------	-------------------

(S590)

<b>7233132</b>	<b>31-12-16.5 (76" loader width)</b> (Order PN 7222581 if loader is equipped with 10-16.5 tires)	<b>\$2,895.00</b>	<b>24.0%</b>	<b>\$0.00</b>	<b>\$2,200.20</b>
----------------	---	-------------------	--------------	---------------	-------------------

(S630, S650)

<b>7178955</b>	<b>12.00-16.5 (79" loader width)</b>	<b>\$3,310.00</b>	<b>24.0%</b>	<b>\$0.00</b>	<b>\$2,515.60</b>
----------------	--------------------------------------	-------------------	--------------	---------------	-------------------

(S740, S750, S770)

<b>7191754</b>	<b>12.00-16.5 (79" loader width)</b>	<b>\$4,100.00</b>	<b>24.0%</b>	<b>\$0.00</b>	<b>\$3,116.00</b>
----------------	--------------------------------------	-------------------	--------------	---------------	-------------------

(S850)

7191757

14.00-17.5 (86" loader width)

\$4,745.00

24.0%

\$0.00

\$3,606.20

**Note on use of poly fill tires with steel tracks - Only pneumatic tires with Superflex formula poly fill manufactured by Arnco are permitted for use inside steel tracks. Bobcat factory poly-filled tires meet this requirement. All other tires are considered non-approved. The use of non-approved tires will void the loader and track warranties.**

Part Number	Stump Grinder Description	SLP in US\$	Discount Percent	Labor	Price
-------------	---------------------------	-------------	------------------	-------	-------

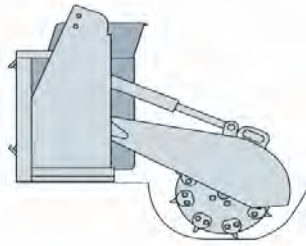

SG30 Stump Grinder

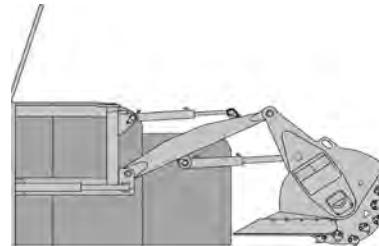

SG60 and SGX60 Stump Grinder

(463, S70, 553)

7100641

**SG30 Stump Grinder**

(Loader must be equipped with a 14-Pin Attachment Control Kit)

\$4,995.00

24.0%

\$0.00

\$3,796.20

(S550H, S530, S530H, S570, S570H, S590, S590H, S220, S220H\*, S250, S250H\*, S300, S300H\*, S330) (S630, S630H, S650, S650H, S740, S740H, S750, S770, S850) (A300, A300H\*) (A770) (T630, T630H, T650, T650H, T750, T770, T870) (T550, T550H, T590, T590H, T250, T250H\*, T300, T300H\*, T320)

6808034

**SG60 Stump Grinder**

**\*Not approved for use with 37 GPM High Flow Loaders**

(Loader must be equipped with an Attachment Control Kit)

(When used on loaders equipped with a 14-Pin Attachment Control Kit, a 14-Pin Attachment T-Harness Kit is required)

\$8,590.00

24.0%

\$0.00

\$6,528.40

(S530H, S570H, S220H, S250H, S300H, S330H) (S630H, S650H, S740H, S750H, S770H, S850H) (A300H) (A770H) (T550H, T590H, T250H, T300H, T320H) (T630H, T650H, T750H, T770H, T870H)

7112201

**SGX60 Stump Grinder**

(Loader must be equipped with an Attachment Control Kit)

(When used on loaders equipped with a 14-Pin Attachment Control Kit, a 14-Pin Attachment T-Harness is required)

\$8,890.00

24.0%

\$0.00

\$6,756.40

Part Number	Sweeper Description	SLP in US\$	Discount Percent	Labor	Price
-------------	---------------------	-------------	------------------	-------	-------

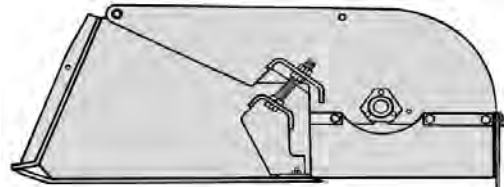

(463, S70) 7138898	44" Sweeper	\$3,090.00	24.0%	\$0.00	\$2,348.40
(S450, T450) 7138870	54" Sweeper	\$3,410.00	24.0%	\$0.00	\$2,591.60
(S450, S510, S550, S530, S570, S590) (T450, T550, T590) 6707144	60" Sweeper	\$3,710.00	24.0%	\$0.00	\$2,819.60
(S510, S550, S530, S570, S590, S220, S250, S300, S330) (S630, S650, S740, S750, S770) (A300) (A770) (T550, T590) (T630, T650) 6707837	72" Sweeper	\$4,135.00	24.0%	\$0.00	\$3,142.60
(S220, S250, S300, S330) (S630, S650, S740, S750, S770) (A300) (A770) (T250, T300, T320) (T630, T650, T750, T770) 7112646	84" Sweeper	\$4,700.00	24.0%	\$0.00	\$3,572.00

Part Number	Accessories Description	SLP in US\$	Discount Percent	Labor	Price
-------------	-------------------------	-------------	------------------	-------	-------

<b>6714219</b>	<b>Gutter Brush</b> (Add-on to the 60" and 72" Sweeper) (Includes hoses, couplers, steel bristles, mounting frame, hardware and control valve) <i>(Price includes \$270 for installation)</i>	<b>\$1,320.00</b>	<b>24.0%</b>	<b>\$270.00</b>	<b>\$1,273.20</b>
----------------	--	-------------------	--------------	-----------------	-------------------

<b>7122418</b>	<b>Gutter Brush</b> (Add-on to the 84" Sweeper) (Includes hoses, couplers, steel bristles, mounting frame, hardware and control valve) <i>(Price includes \$270 for installation)</i>	<b>\$1,260.00</b>	<b>24.0%</b>	<b>\$270.00</b>	<b>\$1,227.60</b>
----------------	--	-------------------	--------------	-----------------	-------------------

<b>Part Number</b>	<b>Tiller Description</b>	<b>SLP in US\$</b>	<b>Discount Percent</b>	<b>Labor</b>	<b>Price</b>
--------------------	---------------------------	--------------------	-------------------------	--------------	--------------

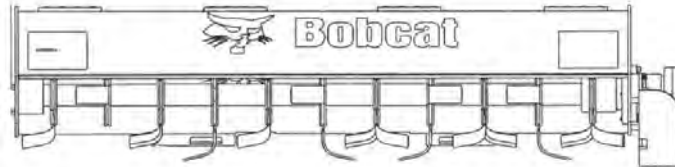

<b>(463, S70, 553, S100) (T110)</b> <b>7196028</b>	<b>40" MI Tiller</b>	<b>\$4,035.00</b>	<b>24.0%</b>	<b>\$0.00</b>	<b>\$3,066.60</b>
---	----------------------	-------------------	--------------	---------------	-------------------

<b>(S450, S510, S550, S550H, S530, S530H, S570, S570H, S590, S590H, S630, S630H, S650, S650H, S740, S750, S750H, S770, S770H)(T450, T550, T550H, T590, T590H) (T630, T630H, T650, T650H)</b> <b>7104371</b>	<b>62" Rotary Tiller</b>	<b>\$4,640.00</b>	<b>24.0%</b>	<b>\$0.00</b>	<b>\$3,526.40</b>
--	--------------------------	-------------------	--------------	---------------	-------------------

<b>(S550, S550H, S530, S530H, S570, S570H, S590, S590H, S630, S630H, S650, S650H, S740, S740H, S750, S750H, S770, S770H) (A770, A770H) (T630, T630H, T650, T650H, T750, T750H, T770, T770H) (T550, T550H, T590, T590H)</b> <b>7102125</b>	<b>76" Rotary Tiller</b>	<b>\$5,640.00</b>	<b>24.0%</b>	<b>\$0.00</b>	<b>\$4,286.40</b>
--	--------------------------	-------------------	--------------	---------------	-------------------

<b>Part Number</b>	<b>Tilt Tach Description</b>	<b>SLP in US\$</b>	<b>Discount Percent</b>	<b>Labor</b>	<b>Price</b>
--------------------	------------------------------	--------------------	-------------------------	--------------	--------------



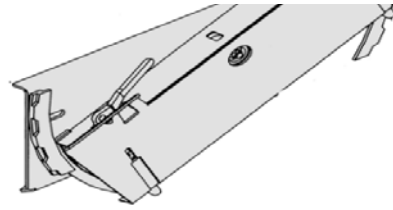

(S450, S510, S550, S530, S570, S590) (S630, S650) (T450, T550, T590)

7101600	<b>Tilt-Tatch</b> (Interface between the Loader's Bob-Tach and non hydraulic attachments)	\$2,330.00	24.0%	\$0.00	\$1,770.80
---------	--	------------	-------	--------	------------

Use of Tilt-Tatch will reduce Operating Capacity and Tip Load by approximately 20%. See the Tilt-Tatch Operators Manual for New Load Ratings.

Tilt-Tatch can be used with non-hydraulic attachments only.

Part Number	Tree Spade Description	SLP in US\$	Discount Percent	Labor	Price
-------------	------------------------	-------------	------------------	-------	-------

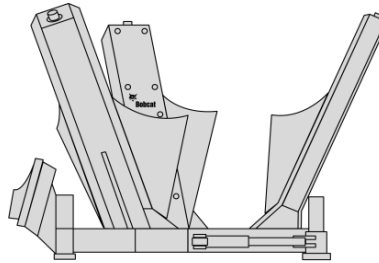

**ACD Tree Spades**

Tree Spades are designed for fingertip spade control on G-Series and newer loaders only. The switches located on the loader's steering lever control Tree Spades. Loaders must be equipped with a 7-Pin control Kit

(S550, S530, S570, S590, S220, S250, S300, S330) (S630, S650, S740, S750, S770, S850)

7149485	<b>32" Convertible Tree Spade, Cone</b> (Must also order Pendant Control Kit or 7-Pin ACD Conversion Kit)	\$10,810.00	24.0%	\$0.00	\$8,215.60
7149442	<b>32" Convertible Tree Spade, Modified</b> (Must also order Pendant Control Kit or 7-Pin ACD Conversion Kit)	\$10,810.00	24.0%	\$0.00	\$8,215.60

(S530, S570, S590, S220, S250, S300, S330) (S630, S650, S740, S750, S770, S850)



<b>(A300) (A770)(T550, T590, T250, T300, T320) (T630, T650, T750, T770, T870)</b>					
<b>7149488</b>	<b>36" Convertible Tree Spade, Cone</b> (Must also order Pendant Control Kit or 7-Pin ACD Conversion Kit)	<b>\$11,430.00</b>	<b>24.0%</b>	<b>\$0.00</b>	<b>\$8,686.80</b>
<b>7149445</b>	<b>36" Convertible Tree Spade, Modified</b> (Must also order Pendant Control Kit or 7-Pin ACD Conversion Kit)	<b>\$11,430.00</b>	<b>24.0%</b>	<b>\$0.00</b>	<b>\$8,686.80</b>
<b>(S220, S250, S300, S330) (S740, S750, S770, S850) (A300) (A770) (T250, T300, T320) (T750, T770, T870)</b>					
<b>7149491</b>	<b>44" Convertible Tree Spade, Cone</b> (Must also order Pendant Control Kit p/n 7152664 or 7-Pin ACD Conversion Kit)	<b>\$15,615.00</b>	<b>24.0%</b>	<b>\$0.00</b>	<b>\$11,867.40</b>
<b>7149306</b>	<b>44" Convertible Tree Spade, Modified</b> (Must also order Pendant Control Kit p/n 7152664 or 7-Pin ACD Conversion Kit)	<b>\$15,525.00</b>	<b>24.0%</b>	<b>\$0.00</b>	<b>\$11,799.00</b>

**Note: Rear Stabilizers are required and counterweights are recommended when using the tree spade**

<b>Part Number</b>	<b>Accessories Description</b>	<b>SLP in US\$</b>	<b>Discount Percent</b>	<b>Labor</b>	<b>Price</b>
<b>7152662</b>	<b>ACD Conversion Kit, 7-Pin</b> (All Loader Series) (Price includes \$90 for installation)	<b>\$270.00</b>	<b>24.0%</b>	<b>\$90.00</b>	<b>\$295.20</b>
<b>7152663</b>	<b>Pendant Control Kit, 3-Blade</b> (For 24" through 36" Convertible Tree Spades) (No additional Control Kits needed.) (Price includes \$90 for installation)	<b>\$480.00</b>	<b>24.0%</b>	<b>\$90.00</b>	<b>\$454.80</b>
<b>7152664</b>	<b>Pendant Control Kit, 4-Blade</b> (For 44" Convertible Tree Spades) (No additional Control Kits needed.) (Will operate 4-Blade convertible Tree Spades) (Price includes \$90 for installation)	<b>\$540.00</b>	<b>24.0%</b>	<b>\$90.00</b>	<b>\$500.40</b>

Part Number	Trench Compactor Description	SLP in US\$	Discount Percent	Labor	Price
-------------	------------------------------	-------------	------------------	-------	-------

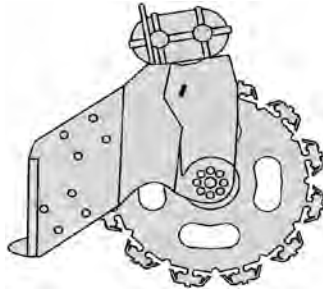

(S510, S550, S530, S570, S590, S220, S250, S300, S330) (A770)

(630, S650, S740, S750, S770)

(T450, T550, T590, T250, T300, T320, T630, T650, T750, T770)

6905277

**Trench Compactor**

(Comes standard with a 4 1/2" Pad and compacts trenches up to 8" wide)

(Wheel-type vibratory compactor)

\$8,290.00

24.0%

\$0.00

\$6,300.40

Part Number	Trencher Description	SLP in US\$	Discount Percent	Labor	Price
-------------	----------------------	-------------	------------------	-------	-------

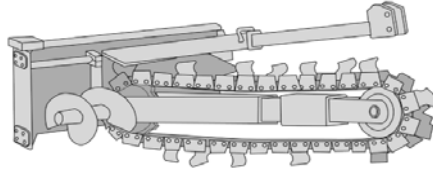

Part Number	LT112 Trencher Description	SLP in US\$	Discount Percent	Labor	Price
-------------	----------------------------	-------------	------------------	-------	-------

(463, S70)					
M7011	<b>LT112 Trencher</b> (Includes mounting frame, hoses, couplers, 2' depth, manual sideshift, 4" trench cleaner) (Can only order one factory installed chain option per trencher model)	\$3,465.00	24.0%	\$0.00	\$2,633.40

*2' Chain Options are 1.654" Double Standard (DS) Anti-Back Flex (ABF)*

M7011-R01-C02	2' x 4" cup teeth, Single Standard pattern	\$455.00	24.0%	\$0.00	\$345.80
M7011-R01-C01	2' x 4" Cup Teeth, Double Standard Pattern	\$555.00	24.0%	\$0.00	\$421.80
M7011-R01-C03	2' x 4" cup & carbide teeth, Double Standard pattern	\$1,015.00	24.0%	\$0.00	\$771.40
M7011-R01-C05	2' x 4" Shark/Cup teeth, Double Standard pattern	\$675.00	24.0%	\$0.00	\$513.00
M7011-R01-C06	2' x 6" Shark/Cup teeth, Double Standard pattern	\$850.00	24.0%	\$0.00	\$646.00

Part Number	LT113 Trencher Description	SLP in US\$	Discount Percent	Labor	Price
-------------	----------------------------	-------------	------------------	-------	-------

(463, S70)					
M7014	<b>LT113 Trencher</b> (Includes mounting frame, hoses, couplers, 3' depth, manual sideshift, 4" trench cleaner) (Can only order one factory installed chain option per trencher model)	\$3,685.00	24.0%	\$0.00	\$2,800.60

*3' Chain Options are 1.654" Double Standard (DS) Anti-Back Flex (ABF)*

M7014-R01-C02	3' x 4" Cup Teeth, Single Standard Pattern	\$440.00	24.0%	\$0.00	\$334.40
M7014-R01-C04	3' x 6" Cup Teeth, Single Standard Pattern	\$470.00	24.0%	\$0.00	\$357.20
M7014-R01-C01	3' x 4" Cup Teeth, Double Standard Pattern	\$500.00	24.0%	\$0.00	\$380.00
M7014-R01-C03	3' x 4" Cup & Carbide Teeth, Double Standard Pattern	\$1,025.00	24.0%	\$0.00	\$779.00

M7014-R01-C06	3' x 4" Shark/Cup Teeth, Double Standard Pattern	\$825.00	24.0%	\$0.00	\$627.00
M7014-R01-C07	3' x 6" Shark/Cup Teeth, Double Standard Pattern	\$1,030.00	24.0%	\$0.00	\$782.80

Part Number	LT213 Trencher Description	SLP in US\$	Discount Percent	Labor	Price
-------------	----------------------------	-------------	------------------	-------	-------

(S450) (T450)					
M7013	<b>LT213 Trencher</b> (Includes 3' depth, manual sideshift, and 4" trench cleaner) (Can only order one factory installed chain option per trencher model)	\$3,710.00	24.0%	\$0.00	\$2,819.60

*Chains are 1.654" Double Standard (DS) Anti-Back Flex (ABF)*

M7013-R01-C02	3' x 4" Cup Teeth, Single Standard Pattern	\$440.00	24.0%	\$0.00	\$334.40
M7013-R01-C04	3' x 6" Cup Teeth, Single Standard Pattern	\$470.00	24.0%	\$0.00	\$357.20
M7013-R01-C01	3' x 4" Cup Teeth, Double Standard Pattern	\$500.00	24.0%	\$0.00	\$380.00
M7013-R01-C03	3' x 4" Cup & Carbide Teeth, Double Standard Pattern	\$1,025.00	24.0%	\$0.00	\$779.00
M7013-R01-C06	3' x 4" Shark/Carbide Teeth, Double Standard Pattern	\$825.00	24.0%	\$0.00	\$627.00
M7013-R01-C07	3' x 6" Shark/Carbide Teeth, Double Standard Pattern	\$960.00	24.0%	\$0.00	\$729.60
M7013-A01-C01	Hydraulic Side Shift	\$657.00	24.0%	\$0.00	\$499.32

Part Number	LT313 Trencher Description	SLP in US\$	Discount Percent	Labor	Price
-------------	----------------------------	-------------	------------------	-------	-------

(S450, S510, S550, S530, S570, S590, S220, S250, S300, S330) (S630, S650, S740, S750, S770)

(A770) (T450, T550, T590) (T630, T650)

M7015	<b>LT313 Trencher</b> (Includes 3' depth, manual sideshift, 6" trench cleaner) (Can only order one factory installed chain option per trencher model)	\$4,475.00	24.0%	\$0.00	\$3,401.00
-------	---	------------	-------	--------	------------

*All chains are 2.0" Double Standard (DS) Anti-Back Flex (ABF)*

M7015-R01-C02	3' x 6" Cup Teeth in Single Standard Pattern	\$620.00	24.0%	\$0.00	\$471.20
M7015-R01-C05	3' x 8" Cup Teeth in Single Standard Pattern	\$655.00	24.0%	\$0.00	\$497.80
M7015-R01-C01	3' x 6" Cup Teeth in Double Standard Pattern	\$1,030.00	24.0%	\$0.00	\$782.80
M7015-R01-C04	3' x 6" Shark Tooth/Cup Teeth in Double Standard Pattern	\$1,040.00	24.0%	\$0.00	\$790.40
M7015-R01-C03	3' x 6" Cup & Carbide Teeth in Double Standard Pattern	\$1,685.00	24.0%	\$0.00	\$1,280.60
M7015-R01-C06	3' x 8" Cup & Carbide Teeth in Double Standard Pattern	\$1,725.00	24.0%	\$0.00	\$1,311.00
M7015-R01-C14	3' x 8" Shark Tooth/Cup Teeth in Double Standard Pattern	\$1,255.00	24.0%	\$0.00	\$953.80

M7015-A01-C01	Hydraulic Side Shift	\$655.00	24.0%	\$0.00	\$497.80
---------------	----------------------	----------	-------	--------	----------

*The LT313 is assembled as a 4' dig depth when ordering the 4' chain option  
(Boom Guide included with 4' factory installed chain)*

M7015-R01-C08	4' x 6" Cup Teeth in Single Standard Pattern	\$765.00	24.0%	\$0.00	\$581.40
M7015-R01-C11	4' x 8" Cup Teeth in Single Standard Pattern	\$860.00	24.0%	\$0.00	\$653.60
M7015-R01-C07	4' x 6" Cup Teeth in Double Standard Pattern	\$945.00	24.0%	\$0.00	\$718.20
M7015-R01-C10	4' x 6" Shark Tooth/Cup Teeth in Double Standard Pattern	\$1,220.00	24.0%	\$0.00	\$927.20
M7015-R01-C09	4' x 6" Cup & Carbide Teeth in Double Standard Pattern	\$1,890.00	24.0%	\$0.00	\$1,436.40
M7015-R01-C12	4' x 8" Cup & Carbide Teeth in Double Standard Pattern	\$2,020.00	24.0%	\$0.00	\$1,535.20
M7015-R01-C15	4' x 8" Shark Tooth/Cup Teeth in Double Standard Pattern	\$1,385.00	24.0%	\$0.00	\$1,052.60

M7015-A01-C01	Hydraulic Side Shift	\$655.00	24.0%	\$0.00	\$497.80
---------------	----------------------	----------	-------	--------	----------

Part Number	LT414 High Flow Trencher Description	SLP in US\$	Discount Percent	Labor	Price
-------------	---	-------------	---------------------	-------	-------

(S550H, S530H, S570H, S590H, S220H, S250H, S300H, S330H)  
(S630H, S650H, S740H, S750H, S770H) (A300H) (A770H)  
(T550H, T590H, T250H, T300H, T320H) (T630H, T650H, T750H, T770H)  
**4' Depth**

(S220H, S250H, S300H, S330H) (S630H, S650H, S740H, S750H, S770H) (A300H) (A770H)  
(T250H, T300H, T320H) (T630H, T650H, T750H, T770H)  
**5' Depth**

<b>M7016</b>	<b>LT414 Trencher</b> (Includes 4' or 5' depth, hydraulic sideshift, and 6" trench cleaner) (Can only order one factory installed chain option per trencher model) (Loader must be equipped with High Flow auxiliary hydraulics)	<b>\$6,675.00</b>	<b>24.0%</b>	<b>\$0.00</b>	<b>\$5,073.00</b>
--------------	---	-------------------	--------------	---------------	-------------------

*Chains are 2.0" Single Standard (SS) or Double Standard (DS) Anti-Back Flex (ABF)*

<b>M7016-R01-C08</b>	<b>4' x 6" Cup Teeth, Single Standard Pattern</b>	<b>\$790.00</b>	<b>24.0%</b>	<b>\$0.00</b>	<b>\$600.40</b>
<b>M7016-R01-C07</b>	<b>4' x 6" Cup Teeth, Double Standard Pattern</b>	<b>\$910.00</b>	<b>24.0%</b>	<b>\$0.00</b>	<b>\$691.60</b>
<b>M7016-R01-C09</b>	<b>4' x 6" Cup &amp; Carbide Teeth, Double Standard Pattern</b>	<b>\$1,890.00</b>	<b>24.0%</b>	<b>\$0.00</b>	<b>\$1,436.40</b>
<b>M7016-R01-C10</b>	<b>4' x 6" Shark Tooth/Cup Teeth in Double Standard Pattern</b>	<b>\$1,565.00</b>	<b>24.0%</b>	<b>\$0.00</b>	<b>\$1,189.40</b>
<b>M7016-R01-C11</b>	<b>4' x 8" Cup Teeth, Single Standard Pattern</b>	<b>\$840.00</b>	<b>24.0%</b>	<b>\$0.00</b>	<b>\$638.40</b>
<b>M7016-R01-C12</b>	<b>4' x 8" Cup &amp; Carbide Teeth in Double Standard Pattern</b>	<b>\$1,965.00</b>	<b>24.0%</b>	<b>\$0.00</b>	<b>\$1,493.40</b>
<b>M7016-R01-C14</b>	<b>4' x 8" Shark/Carbide Teeth in Double Standard Pattern</b>	<b>\$1,450.00</b>	<b>24.0%</b>	<b>\$0.00</b>	<b>\$1,102.00</b>
<b>M7016-R01-C04</b>	<b>5' x 6" Cup Teeth, Single Standard Pattern</b>	<b>\$940.00</b>	<b>24.0%</b>	<b>\$0.00</b>	<b>\$714.40</b>
<b>M7016-R01-C01</b>	<b>5' x 6" Cup Teeth, Double Standard Pattern</b>	<b>\$1,075.00</b>	<b>24.0%</b>	<b>\$0.00</b>	<b>\$817.00</b>
<b>M7016-R01-C03</b>	<b>5' x 6" Cup &amp; Carbide Teeth, Double Standard Pattern</b>	<b>\$2,240.00</b>	<b>24.0%</b>	<b>\$0.00</b>	<b>\$1,702.40</b>
<b>M7016-R01-C02</b>	<b>5' x 6" Shark Tooth/Cup Teeth in Double Standard Pattern</b>	<b>\$1,785.00</b>	<b>24.0%</b>	<b>\$0.00</b>	<b>\$1,356.60</b>
<b>M7016-R01-C06</b>	<b>5' x 8" Cup Teeth, Single Standard Pattern</b>	<b>\$995.00</b>	<b>24.0%</b>	<b>\$0.00</b>	<b>\$756.20</b>
<b>M7016-R01-C05</b>	<b>5' x 8" Cup &amp; Carbide Teeth in Double Standard Pattern</b>	<b>\$2,450.00</b>	<b>24.0%</b>	<b>\$0.00</b>	<b>\$1,862.00</b>

Part Number	LT405 High Flow Trencher Description	SLP in US\$	Discount Percent	Labor	Price
-------------	---	-------------	------------------	-------	-------

(S530H, S570H, S590H, S220H, S250H, S300H, S330H) (S630H, S650H, S740H, S750H, S770H)  
(A300H) (A770H) (T550H, T590H, T250H, T300H, T320H)  
(T630H, T650H, T750H, T770H)

6906100	<b>LT405 Trencher</b> (Includes 3' – 4' adjustable boom setup at 4', double standard ABF chain, Hydraulic Sideshift, 6" trench cleaner, hoses and couplers) <b>(Must also order teeth)</b>	\$10,485.00	24.0%	\$0.00	\$7,968.60
---------	---	-------------	-------	--------	------------

Part Number	Vibratory Roller Description	SLP in US\$	Discount Percent	Labor	Price
-------------	------------------------------	-------------	------------------	-------	-------

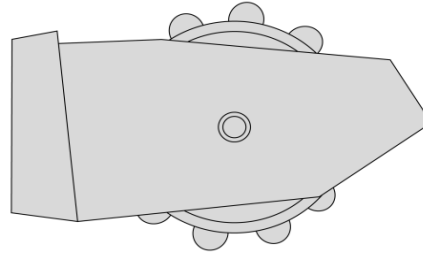

(S450, S510, S550, S530, S570, S590) (T450, T550, T590)

7165403	48" Vibratory Roller with Padded Drum	\$8,440.00	24.0%	\$0.00	\$6,414.40
7165404	48" Vibratory Roller with Smooth Drum	\$8,235.00	24.0%	\$0.00	\$6,258.60

(S590, S220, S250, S300, S330) (S630, S650, S750, S770, S850) (A300) (A770)

(T250, T300, T320) (T630, T650, T750, T770, T870)

7165401	73" Vibratory Roller with Padded Drum	\$9,730.00	24.0%	\$0.00	\$7,394.80
7165402	73" Vibratory Roller with Smooth Drum	\$9,470.00	24.0%	\$0.00	\$7,197.20

(S250, S300, S330) (S750, S770, S850) (A300) (A770) (T250, T300, T320)

(T630, T750, T770, T870)

7165400	80" Vibratory Roller with Smooth Drum	\$10,195.00	24.0%	\$0.00	\$7,748.20
---------	---------------------------------------	-------------	-------	--------	------------



Part Number	Wheel Saw Description	SLP in US\$	Discount Percent	Labor	Price
-------------	-----------------------	-------------	------------------	-------	-------

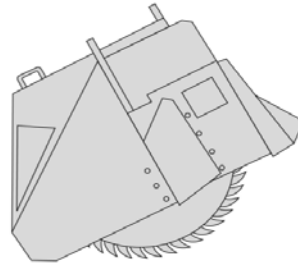

**18" Wheel Saw with 3" Wheel**

(Must order the two part numbers listed below—18" Wheel Saw and 3" Wheel)

(Must also order Attachment Control Kit)

(S530H, S570H, S590H, S220H, S250H, S300H, S330H) (S630H, S650H, S740H, S750H, S770H, S850, S850H) (A300H) (A770H) (T550H, T590H, T250H, T300H, T320H)  
(T630H, T650H, T750H, T770H, T870, T870H)

6729537	WS18 Wheel Saw	\$15,295.00	24.0%	\$0.00	\$11,624.20
6729544	3" Wheel	\$3,315.00	24.0%	\$0.00	\$2,519.40

(Weight 650 lbs. Wheel Width 3.13")

**Note: There is no Trench Cleaner available with the 3" Wheel.**

**18" Wheel Saw with 6" Wheel and 6" Trench Cleaner**

(Must order the three part numbers listed below—18" Wheel Saw, 6" Wheel and 6" Trench Cleaner)

(Must also order Attachment Control Kit)

(S530H, S570H, S590H, S220H, S250H, S300H, S330H) (S630H, S650H, S740H, S750H, S770H, S850, S850H) (A300H) (A770H) (T550H, T590H, T250H, T300H, T320H)  
(T630H, T650H, T750H, T770H, T870, T870H)

6729537	WS18 Wheel Saw	\$15,295.00	24.0%	\$0.00	\$11,624.20
6729546	6" Wheel	\$3,315.00	24.0%	\$0.00	\$2,519.40

(Weight 395 lbs., Wheel Width 6.25")

6729550	6" Trench Cleaner	\$1,235.00	24.0%	\$0.00	\$938.60
---------	-------------------	------------	-------	--------	----------

(Weight 95 lbs.)

**24" Wheel Saw with 6" Wheel and 6" Trench Cleaner**

(Must order the three part numbers listed below—24" Wheel Saw, 6" Wheel and 6" Trench Cleaner)

(Must also order Attachment Control Kit)

(S250H, S300H, S330H) (S740H, S750H, S770H, S850, S850H) (A300H) (A770H)

(T250H, T300H, T320H) (T750H, T770H, T870, T870H)

6729566	WS24 Wheel Saw	\$17,660.00	24.0%	\$0.00	\$13,421.60
6729573	6" Wheel (Weight 585 lbs., Wheel Width 6.25")	\$4,310.00	24.0%	\$0.00	\$3,275.60
6729577	6" Trench Cleaner (Weight 130 lbs.)	\$1,415.00	24.0%	\$0.00	\$1,075.40

**24" Wheel Saw with 8" Wheel and 8" Trench Cleaner**

(Must order the three part numbers listed below—24" Wheel Saw, 8" Wheel and 8" Trench Cleaner)

(Must also order Attachment Control Kit)

(S250H, S300H, S330H) (S740H, S750H, S770H, S850, S850H) (A300H) (A770H)

(T250H, T300H, T320H) (T750H, T770H, T870, T870H)

6729566	WS24 Wheel Saw	\$17,660.00	24.0%	\$0.00	\$13,421.60
6729575	8" Wheel (Weight 618 lbs., Wheel Width 7.88")	\$5,000.00	24.0%	\$0.00	\$3,800.00
6729579	8" Trench Cleaner (Weight 148 lbs.)	\$1,515.00	24.0%	\$0.00	\$1,151.40

April 1, 2015  
BOBCAT SLP Pages



Part Number	Compact Excavator Description	SLP in US\$	Discount Percent	Price
M5503	418 Excavator (equipped with Tier 4 engine)	\$23,090.00	30.0%	\$ 16,163.00

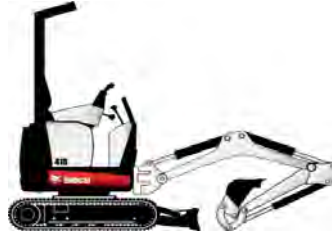

Part Number	Compact Excavator Description	SLP in US\$	Discount Percent	Price
M5519	E20 Compact Excavator (equipped with Tier 4 engine)	\$30,963.00	30.0%	\$ 21,674.10



Part Number	MUST ORDER A CONTROL PKG Description	SLP in US\$	Discount Percent	Price
M5519-A02-C00	<b>Basic Control Package</b> Incls Foot Controls for Auxiliary Hydraulics and Boom Swing Control and Manual Shift Travel System	\$0.00	30.0%	\$0.00
M5519-A01-C01	<b>Control Enhancement Package</b> Incls Fingertip Auxiliary Hydraulics and Boom Swing Controls and Auto-Shift Travel System (Advanced Controls Pkg)	\$484.00	30.0%	\$ 338.80

Part Number	Factory Installed Options Description	SLP in US\$	Discount Percent	Price
M5519-A02-C02	<b>Heated Cab</b> Incls Enclosed ROPS/TOPS Cab with Heater, Fingertip Auxiliary Hydraulics &	\$3,667.00	30.0%	\$ 2,566.90

Boom Swing Control and Auto-shift Travel System (Advanced Controls Pkg)

Part Number	Compact Excavator Description	SLP in US\$	Discount Percent	Price
M3003	<b>E26 Compact Excavator (equipped with Tier 4 engine)</b>	\$36,740.00	30.0%	\$ 25,718.00



Part Number	Factory Installed Arm Options Description	SLP in US\$	Discount Percent	Price
M3003-R03-C02	Long Arm & Add on Counterweight	\$1,299.00	30.0%	\$ 909.30

Part Number	Factory Installed Options Description	SLP in US\$	Discount Percent	Price
M3003-R01-C03	<b>Cab Enclosure with Heat and Air Conditioning</b> Incls deluxe cloth suspension seat with high back. Increased operate weight by 328#	\$5,732.00	30.0%	\$ 4,012.40
M3003-R11-C02	Travel Motion Alarm	\$285.00	30.0%	\$ 199.50
M3003-R08-C03	Hydraulic Clamp (std arm or long arm)	\$1,787.00	30.0%	\$ 1,250.90
M3003-R07-C02	Secondary Auxiliary Hydraulics	\$1,076.00	30.0%	\$ 753.20
M3003-R14-C04	Deluxe Panel with Keyless Start	\$498.00	30.0%	\$ 348.60

Part Number	Compact Excavator Description	SLP in US\$	Discount Percent	Price
M3009	<b>E32i Compact Excavator (equipped with Tier 4 engine)</b>	\$45,834.00	30.0%	\$ 32,083.80



Part Number	Air Conditioned/Heated Cab Packages Description	SLP in US\$	Discount Percent	Price
M___-P01-A96	A96 Option Package	\$11,235.00	30.0%	\$ 7,864.50
M___-P01-A91	A91 Option Package	\$10,760.00	30.0%	\$ 7,532.00
M___-P01-A76	A76 Option Package	\$9,318.00	30.0%	\$ 6,522.60
M___-P01-A71	A71 Option Package	\$8,833.00	30.0%	\$ 6,183.10
M___-P01-A51	A51 Option Package	\$7,188.00	30.0%	\$ 5,031.60
M___-P01-A31	A31 Option Package	\$5,732.00	30.0%	\$ 4,012.40

<u>A31</u>	<u>A71**</u>	<u>A91</u>	<u>A96</u>
Enclosed Cab with Heat/AC	Enclosed Cab with Heat/AC	Enclosed Cab with Heat/AC	Enclosed Cab with Heat/AC
Deluxe Cloth Suspension Seat	Deluxe Cloth Suspension Seat	Deluxe Cloth Suspension Seat	Deluxe Cloth Suspension Seat
	Hydraulic X-Change	Hydraulic X-Change	Hydraulic X-Change
	Hydraulic Clamp (Class III)	Hydraulic Clamp (Class III)	Pro- Clamp System (Class III)
		Travel Motion Alarm	Travel Motion Alarm
		Second Aux Hydraulics	Second Aux Hydraulics
		Radio	Radio
		Dlx Panel-Keyless Ignition	Dlx Panel-Keyless Ignition

<u>A51</u>	<u>A76</u>
Enclosed Cab with Heat/AC	Enclosed Cab with Heat/AC
Deluxe Cloth Suspension Seat	Deluxe Cloth Suspension Seat
Hydraulic X-Change	Hydraulic X-Change
	Pro-Clamp System (Class III)

\*\*NOTE: When adding an Extendable Arm Option to the O71, H71 & A71 Option Pkgs, Secondary Auxiliary Hydraulics must be added to the order and added automatically on quote

Part Number	Heated Cab Packages Description	SLP in US\$	Discount Percent	Price
M2009-P01-H76	H76 Option Package	\$8,624.00	30.0%	\$ 6,036.80
M___-P01-H71	H71 Option Package	\$8,124.00	30.0%	\$ 5,686.80
M___-P01-H51	H51 Option Package	\$6,330.00	30.0%	\$ 4,431.00
M___-P01-H31	H31 Option Package	\$4,823.00	30.0%	\$ 3,376.10

<u>H31</u>	<u>H51</u>	<u>H71**</u>	<u>H76</u>
Enclosed Cab with Heat	Enclosed Cab with Heat	Enclosed Cab with Heat	Enclosed Cab with Heat
Deluxe Cloth Suspension Seat	Deluxe Cloth Suspension Seat	Deluxe Cloth Suspension Seat	Deluxe Cloth Suspension Seat
	Hydraulic X-Change	Hydraulic X-Change	Hydraulic X-Change

Hydraulic Clamp (Class III)      Pro-Clamp System (Class III)

\*\*NOTE: When adding an Extendable Arm Option to the O71, H71 & A71 Option Pkgs, Secondary Auxiliary Hydraulics must be added to the order

Part Number	Open Cab Packages Description	SLP in US\$	Discount Percent	Price
M___-P01-O76	<b>O76 Option Package</b>	<b>\$3,867.00</b>	<b>30.0%</b>	<b>\$ 2,706.90</b>
M___-P01-O71	<b>O71 Option Package</b>	<b>\$3,382.00</b>	<b>30.0%</b>	<b>\$ 2,367.40</b>
M___-P01-O51	<b>O51 Option Package</b>	<b>\$1,569.00</b>	<b>30.0%</b>	<b>\$ 1,098.30</b>

<u>O51</u>	<u>O71**</u>	<u>O76</u>
Hydraulic X-Change	Hydraulic X-Change Hydraulic Clamp (Class III)	Hydraulic X-Change Pro-Clamp System (Class III)

\*\*NOTE: When adding an Extendable Arm Option to the O71, H71 & A71 Option Pkgs, Secondary Auxiliary Hydraulics must be added to the order. Pro-Clamp is not compatible with an Extendable Arm

Part Number	Factory Installed Arm Options Description	SLP in US\$	Discount Percent	Price
M___-R03-C02	<b>Long Arm &amp; Counterweight</b> Increases operating weight by 675 lbs	<b>\$1,545.00</b>	<b>30.0%</b>	<b>\$ 1,081.50</b>
M___-R03-C03	<b>Extendable Arm &amp; Counterweight</b> Increases operating weight by 906 lbs. Pro-Clamp is not compatible with Ext Arm	<b>\$4,200.00</b>	<b>30.0%</b>	<b>\$ 2,940.00</b>

Part Number	Factory Installed Options Description	SLP in US\$	Discount Percent	Price
M___-R14-C02	<b>Deluxe Display incls Keyless Start</b>	<b>\$498.00</b>	<b>30.0%</b>	<b>\$ 348.60</b>
M___-R04-C02	<b>Keyless Start</b>	<b>\$165.00</b>	<b>30.0%</b>	<b>\$ 115.50</b>
M___-R08-C03	<b>Hydraulic Clamp - Avail for Std Arm, Long Arm and Extendable Arm.</b> Second Auxiliary Hydraulics are required when ordering both the Hydraulic Clamp and Extendable Arm from the factory.	<b>\$1,918.00</b>	<b>30.0%</b>	<b>\$ 1,342.60</b>
M___-R08-C12	<b>Pro Clamp System (Class III) - For Std Arm and Long Arm Only.</b> Includes Pro Clamp base and Material Clamp	<b>\$2,418.00</b>	<b>30.0%</b>	<b>\$ 1,692.60</b>
M___-R26-C02	<b>Radio</b>	<b>\$397.00</b>	<b>30.0%</b>	<b>\$ 277.90</b>
M___-R07-C02	<b>Second Auxiliary Hydraulics</b>	<b>\$1,076.00</b>	<b>30.0%</b>	<b>\$ 753.20</b>
M___-R11-C02	<b>Travel Motion Alarm</b>	<b>\$285.00</b>	<b>30.0%</b>	<b>\$ 199.50</b>

Part Number	Factory Installed Track Options Description	SLP in US\$	Discount Percent	Price
M___-R02-C02	<b>Steel Tracks</b> Increases operating weight by 212 lbs	\$2,385.00	30.0%	\$ 1,669.50

Part Number	Compact Excavator Description	SLP in US\$	Discount Percent	Price
M3011	<b>E35i ZTS Compact Excavator (equipped with Tier 4 engine)</b>	\$47,209.00	30.0%	\$ 33,046.30



Part Number	Air Conditioned/Heated Cab Packages Description	SLP in US\$	Discount Percent	Price
M___-P01-A96	<b>A96 Option Package</b>	\$13,668.00	30.0%	\$ 9,567.60
M___-P01-A91	<b>A91 Option Package</b>	\$13,193.00	30.0%	\$ 9,235.10
M___-P01-A76	<b>A76 Option Package</b>	\$9,318.00	30.0%	\$ 6,522.60
M___-P01-A71	<b>A71 Option Package</b>	\$8,833.00	30.0%	\$ 6,183.10
M___-P01-A51	<b>A51 Option Package</b>	\$7,188.00	30.0%	\$ 5,031.60
M___-P01-A31	<b>A31 Option Package</b>	\$5,732.00	30.0%	\$ 4,012.40

<u>A31</u>	<u>A71**</u>	<u>A91</u>	<u>A96</u>
Enclosed Cab with Heat/AC	Enclosed Cab with Heat/AC	Enclosed Cab with Heat/AC	Enclosed Cab with Heat/AC
Deluxe Cloth Suspension Seat	Deluxe Cloth Suspension Seat	Deluxe Cloth Suspension Seat	Deluxe Cloth Suspension Seat
	Hydraulic X-Change	Hydraulic X-Change	Hydraulic X-Change
	Hydraulic Clamp (Class III)	Hydraulic Clamp (Class III)	Pro- Clamp System (Class III)
		Travel Motion Alarm	Travel Motion Alarm
		Second Aux Hydraulics	Second Aux Hydraulics
		Radio	Radio
		Dlx Panel-Keyless Ignition	Dlx Panel-Keyless Ignition

<u>A51</u>	<u>A76</u>
Enclosed Cab with Heat/AC	Enclosed Cab with Heat/AC
Deluxe Cloth Suspension Seat	Deluxe Cloth Suspension Seat

Hydraulic X-Change

Hydraulic X-Change  
Pro-Clamp System (Class III)

Hydr Angle Blade

Hydr Angle Blade

\*\*NOTE: When adding an Extendable Arm Option to the O71, H71 & A71 Option Pkgs,  
Secondary Auxiliary Hydraulics must be added to the order

Part Number	Heated Cab Packages Description	SLP in US\$	Discount Percent	Price
M___-P01-H76	H76 Option Package	\$8,624.00	30.0%	\$ 6,036.80
M___-P01-H71	H71 Option Package	\$8,124.00	30.0%	\$ 5,686.80
M___-P01-H51	H51 Option Package	\$6,330.00	30.0%	\$ 4,431.00
M___-P01-H31	H31 Option Package	\$4,823.00	30.0%	\$ 3,376.10

H31  
Enclosed Cab with Heat

H51  
Enclosed Cab with Heat

H71\*\*  
Enclosed Cab with Heat

H76\*\*  
Enclosed Cab with Heat

Deluxe Cloth Suspension Seat

Deluxe Cloth Suspension Seat  
Hydraulic X-Change

Deluxe Cloth Suspension Seat

Deluxe Cloth Suspension Seat  
Hydraulic X-Change  
Pro-Clamp System (Class III)

\*\*NOTE: When adding an Extendable Arm Option to the O71, H71 & A71 Option Pkgs,  
Secondary Auxiliary Hydraulics must be added to the order

Part Number	Open Cab Packages Description	SLP in US\$	Discount Percent	Price
M___-P01-O76	O76 Option Package	\$3,867.00	30.0%	\$ 2,706.90
M___-P01-O71	O71 Option Package	\$3,382.00	30.0%	\$ 2,367.40
M___-P01-O51	O51 Option Package	\$1,569.00	30.0%	\$ 1,098.30

O51  
Hydraulic X-Change

O71\*\*  
Hydraulic X-Change  
Hydraulic Clamp (Class III)

O76  
Hydraulic X-Change  
Pro-Clamp System (Class III)

\*\*NOTE: When adding an Extendable Arm Option to the O71, H71 & A71 Option Pkgs,  
Secondary Auxiliary Hydraulics must be added to the order

Part Number	Factory Installed Arm Options Description	SLP in US\$	Discount Percent	Price
M___-R03-C02	Long Arm & Counterweight Increases operating weight by 675 lbs	\$1,545.00	30.0%	\$ 1,081.50



M___-R03-C03	<b>Extendable Arm &amp; Counterweight</b> Increases operating weight by 906 lbs	\$4,200.00	30.0%	\$	2,940.00
--------------	--	------------	-------	----	----------

Part Number	Factory Installed Options Description	SLP in US\$	Discount Percent		Price
M___-R12-C02	<b>Hydraulic Angle Blade</b> Increases operating weight by 212 lbs	\$2,561.00	30.0%	\$	1,792.70
M___-R14-C02	<b>Deluxe Display incls Keyless Start</b>	\$498.00	30.0%	\$	348.60
M___-R04-C02	<b>Keyless Start</b>	\$165.00	30.0%	\$	115.50
M___-R08-C03	<b>Hydraulic Clamp - Avail for Std Arm, Long Arm and Extendable Arm.</b> Second Auxiliary Hydraulics are required when ordering both the Hydraulic Clamp and Extendable Arm from the factory.	\$1,918.00	30.0%	\$	1,342.60
M___-R08-C12	<b>Pro Clamp System (Class III) - For Std Arm and Long Arm Only.</b> Includes Pro Clamp base and Material Clamp	\$2,418.00	30.0%	\$	1,692.60
M___-R26-C02	<b>Radio</b>	\$397.00	30.0%	\$	277.90
M___-R07-C02	<b>Second Auxiliary Hydraulics</b>	\$1,076.00	30.0%	\$	753.20
M___-R11-C02	<b>Travel Motion Alarm</b>	\$285.00	30.0%	\$	199.50

Part Number	Factory Installed Track Options Description	SLP in US\$	Discount Percent		Price
M___-R02-C02	<b>Steel Tracks</b> Increases operating weight by 212 lbs	\$2,385.00	30.0%	\$	1,669.50

Part Number	Compact Excavator Description	SLP in US\$	Discount Percent		Price
M3205	<b>E32 Compact Excavator (equipped with Tier 4 engine)</b>	\$49,712.00	30.0%	\$	34,798.40
M3207	<b>E35 ZTS Compact Excavator (equipped with Tier 4 engine)</b>	\$51,054.00	30.0%	\$	35,737.80



Part Number	Air Conditioned/Heated Cab Packages Description	SLP in US\$	Discount Percent	Price
M3207-P01-A96	A96 Option Package – E35 includes Hydraulic Angle Blade	\$13,668.00	30.0%	\$ 9,567.60
M3207-P01-A91	A91 Option Package – E35 includes Hydraulic Angle Blade	\$13,193.00	30.0%	\$ 9,235.10
M3205-P01-A96	A96 Option Package – E32 does not include Hydraulic Angle Blade	\$11,235.00	30.0%	\$ 7,864.50
M3205-P01-A91	A91 Option Package – E32 does not include Hydraulic Angle Blade	\$10,760.00	30.0%	\$ 7,532.00
M____-P01-A76	A76 Option Package	\$9,318.00	30.0%	\$ 6,522.60
M____-P01-A71	A71 Option Package	\$8,833.00	30.0%	\$ 6,183.10
M____-P01-A51	A51 Option Package	\$7,188.00	30.0%	\$ 5,031.60
M____-P01-A31	A31 Option Package	\$5,732.00	30.0%	\$ 4,012.40

<u>A31</u>	<u>A71**</u>	<u>A91</u>	<u>A96</u>
Enclosed Cab with Heat/AC	Enclosed Cab with Heat/AC	Enclosed Cab with Heat/AC	Enclosed Cab with Heat/AC
Deluxe Cloth Suspension Seat	Deluxe Cloth Suspension Seat	Deluxe Cloth Suspension Seat	Deluxe Cloth Suspension Seat
	Hydraulic X-Change	Hydraulic X-Change	Hydraulic X-Change
	Hydraulic Clamp (Class III)	Hydraulic Clamp	Pro-Clamp System (Class III)
		Second Aux Hydraulics	Second Aux Hydraulics
		Hydraulic Angle Blade*	Hydraulic Angle Blade*
		Dlx Panel w/Keyless Ignition	Dlx Panel w/Keyless Ignition
		Travel Motion Alarm	Travel Motion Alarm
		Radio	Radio
		*Applies to E35 only	*Applies to E35 only

\*\*NOTE: When adding an Extendable Arm Option to the O71, H71 & A71 Option Pkgs, Secondary Auxiliary Hydraulics must be added to the order

Part Number	Heated Cab Packages Description	SLP in US\$	Discount Percent	Price
M____-P01-H76	H76 Option Package	\$8,624.00	30.0%	\$ 6,036.80
M____-P01-H71	H71 Option Package	\$8,124.00	30.0%	\$ 5,686.80
M____-P01-H51	H51 Option Package	\$6,330.00	30.0%	\$ 4,431.00
M____-P01-H31	H31 Option Package	\$4,823.00	30.0%	\$ 3,376.10

<u>H31</u>	<u>H51</u>	<u>H71**</u>	<u>H76</u>
Enclosed Cab with Heat	Enclosed Cab with Heat	Enclosed Cab with Heat	Enclosed Cab with Heat

Deluxe Cloth Suspension Seat

Deluxe Cloth Suspension Seat

Deluxe Cloth Suspension Seat

Deluxe Cloth Suspension  
Seat

Hydraulic X-Change

Hydraulic X-Change

Hydraulic X-Change

Hydraulic Clamp (Class III)

Pro-Clamp System (Class  
III)

\*\*NOTE: When adding an Extendable Arm Option to the O71, H71 & A71 Option Pkgs,  
Secondary Auxiliary Hydraulics must be added to the order

Part Number	Open Cab Packages Description	SLP in US\$	Discount Percent	Price
M___-P01-O76	<b>O76 Option Package</b>	<b>\$3,867.00</b>	<b>30.0%</b>	<b>\$ 2,706.90</b>
M___-P01-O71	<b>O71 Option Package</b>	<b>\$3,382.00</b>	<b>30.0%</b>	<b>\$ 2,367.40</b>
M___-P01-O51	<b>O51 Option Package</b>	<b>\$1,569.00</b>	<b>30.0%</b>	<b>\$ 1,098.30</b>

O51

Hydraulic X-Change

O71\*\*

Hydraulic X-Change

Hydraulic Clamp (Class III)

O76

Hydraulic X-Change

Pro-Clamp System (Class III)

\*\*NOTE: When adding an Extendable Arm Option to the O71, H71 & A71 Option Pkgs,  
Secondary Auxiliary Hydraulics must be added to the order. Pro Clamp is not compatible  
with Ext Arm

Part Number	Factory Installed Arm Options Description	SLP in US\$	Discount Percent	Price
M___-R03-C02	<b>Long Arm &amp; Counterweight</b> Increases operating weight by 675 lbs	<b>\$1,545.00</b>	<b>30.0%</b>	<b>\$ 1,081.50</b>
M___-R03-C03	<b>Extendable Arm &amp; Counterweight</b> Increases operating weight by 906 lbs. Pro-Clamp not compatible	<b>\$4,200.00</b>	<b>30.0%</b>	<b>\$ 2,940.00</b>

Part Number	Factory Installed Options Description	SLP in US\$	Discount Percent	Price
M3207-R12-C02	<b>Hydraulic Angle Blade – E35 Only</b> Increases operating weight by 212 lbs	<b>\$2,561.00</b>	<b>30.0%</b>	<b>\$ 1,792.70</b>
M___-R14-C02	<b>Deluxe Display incls Keyless Start</b>	<b>\$498.00</b>	<b>30.0%</b>	<b>\$ 348.60</b>
M___-R04-C02	<b>Keyless Start</b>	<b>\$165.00</b>	<b>30.0%</b>	<b>\$ 115.50</b>
M___-R08-C03	<b>Hydraulic Clamp - Avail for Std Arm, Long Arm and Extendable Arm.</b> Second Auxiliary Hydraulics are required when ordering both the Hydraulic Clamp and Extendable Arm from the factory.	<b>\$1,918.00</b>	<b>30.0%</b>	<b>\$ 1,342.60</b>

M___-R08-C12	<b>Pro Clamp - Available for Std Arm and Long Arm Only</b> Includes Pro Clamp base and Material Clamp	\$2,418.00	30.0%	\$	1,692.60
M___-R26-C02	<b>Radio</b>	\$397.00	30.0%	\$	277.90
M___-R07-C02	<b>Second Auxiliary Hydraulics</b>	\$1,076.00	30.0%	\$	753.20
M___-R11-C02	<b>Travel Motion Alarm</b>	\$285.00	30.0%	\$	199.50

Part Number	Factory Installed Track Options Description	SLP in US\$	Discount Percent		Price
M___-R02-C02	<b>Steel Tracks</b> Increases operating weight by 212 lbs	\$2,385.00	30.0%	\$	1,669.50

Part Number	Compact Excavator Description	SLP in US\$	Discount Percent		Price
M3213	<b>E42 Compact Excavator (equipped with Final Tier 4 engine)</b>	\$53,024.00	30.0%	\$	37,116.80



Part Number	Air Conditioned/Heated Cab Packages Description	SLP in US\$	Discount Percent	Price
M3213-P01-A96	A96 Option Package	\$14,897.00	30.0%	\$ 10,427.90
M3213-P01-A94	A94 Option Package	\$14,422.00	30.0%	\$ 10,095.40
M3213-P01-A91	A91 Option Package	\$14,034.00	30.0%	\$ 9,823.80
M3213-P01-A76	A76 Option Package	\$10,292.00	30.0%	\$ 7,204.40
M3213-P01-A74	A74 Option Package	\$9,807.00	30.0%	\$ 6,864.90
M3213-P01-A71	A71 Option Package	\$9,411.00	30.0%	\$ 6,587.70
M3213-P01-A51	A51 Option Package	\$7,681.00	30.0%	\$ 5,376.70
M3213-P01-A31	A31 Option Package	\$6,234.00	30.0%	\$ 4,363.80

<u>A31</u>	<u>A71**</u>	<u>A74**</u>	<u>A91</u>	<u>A94</u>	<u>A96</u>
Enclosed Cab with Heat/AC	Enclosed Cab with Heat/AC	Enclosed Cab with Heat/AC	Enclosed Cab with Heat/AC	Enclosed Cab with Heat/AC	Enclosed Cab with Heat/AC
Deluxe Cloth Suspension Seat	Deluxe Cloth Suspension	Deluxe Cloth Suspension Seat	Deluxe Cloth Suspension Seat	Deluxe Cloth Suspension Seat	Deluxe Cloth Suspension Seat
	Hydraulic X-Change	Hydraulic X-Change	Hydraulic X-Change	Hydraulic X-Change	Hydraulic X-Change
	Hydraulic Clamp (Class III)	Hydraulic Clamp (Class IV)	Hydraulic Clamp (Class III)	Hydraulic Clamp (Class IV)	Pro-Clamp System (Class IV)
			Second Auxiliary Hydraulics	Second Auxiliary Hydraulics	Second Auxiliary Hydraulics
			Hydraulic Angle Blade	Hydraulic Angle Blade	Hydraulic Angle Blade
<u>A51</u>	<u>A76**</u>				
Enclosed Cab with Heat/AC	Enclosed Cab with Heat/AC		Dlx Panel w/Keyless Ignition	Dlx Panel w/Keyless Ignition	Dlx Panel w/Keyless Ignition
Deluxe Cloth Suspension Seat	Deluxe Cloth Suspension		Travel Motion Alarm	Travel Motion Alarm	Travel Motion Alarm
Hydraulic X-Change	Hydraulic X-Change		Radio	Radio	Radio
	Pro-Clamp System (Class IV)				

Part Number	Open Cab Packages Description	SLP in US\$	Discount Percent	Price
M3213-P01-O76	O76 Option Package	\$4,364.00	30.0%	\$ 3,054.80
M3213-P01-O74	O74 Option Package	\$3,879.00	30.0%	\$ 2,715.30
M3213-P01-O71	O71 Option Package	\$3,482.00	30.0%	\$ 2,437.40
M3213-P01-O51	O51 Option Package	\$1,569.00	30.0%	\$ 1,098.30

<u>O51</u>	<u>O71**</u>	<u>O74**</u>	<u>O76</u>
Hydraulic X-Change	Hydraulic X-Change	Hydraulic X-Change	Hydraulic X-Change
	Hydraulic Clamp (Class III)	Hydraulic Clamp (Class IV)	Pro-Clamp (Class IV)

\*\*NOTE: When adding an Extendable Arm Option to the O71, O74, A71 & A74 Opt Pkgs, Second Auxiliary Hydraulics will automatically be added to the configuration.  
Pro Clamp is not compatible with Ext Arm

Part Number	Factory Installed Options Description	SLP in US\$	Discount Percent	Price
M3213-R03-C02	<b>Long Arm &amp; Counterweight</b> Increases operating weight by 460 lbs	\$2,033.00	30.0%	\$ 1,423.10
M3213-R03-C03	<b>Extendable Arm &amp; Counterweight</b> Increases operating weight by 730 lbs. Pro-Clamp not compatible	\$5,697.00	30.0%	\$ 3,987.90

Part Number	Factory Installed Options Description	SLP in US\$	Discount Percent	Price
M3213-R12-C02	<b>Hydraulic Angle Blade</b> Increases operating weight by 170 lbs	\$2,561.00	30.0%	\$ 1,792.70
M3213-R04-C02	<b>Keyless Start</b>	\$203.00	30.0%	\$ 142.10
M3213-R08-C03	<b>Hydraulic Clamp (Class III)</b> Available for Standard Arm and Long Arm only	\$2,021.00	30.0%	\$ 1,414.70
M3213-R08-C08	<b>Hydraulic Clamp (Class IV) Avail for Std Arm, Long Arm and Ext Arm</b> Second Auxiliary Hydraulics are required when ordering both the Hydraulic Clamp and Extendable Arm from the factory.	\$2,430.00	30.0%	\$ 1,701.00
M3213-R08-C12	<b>Pro Clamp System (Class IV) Avail for Std Arm and Long Arm Only</b> Includes Pro Clamp Base and Material Clamp	\$2,930.00	30.0%	\$ 2,051.00
M3213-R26-C02	<b>Radio</b>	\$397.00	30.0%	\$ 277.90
M3213-R07-C02	<b>Second Auxiliary Hydraulics</b>	\$1,366.00	30.0%	\$ 956.20
M3213-R11-C02	<b>Travel Motion Alarm</b>	\$285.00	30.0%	\$ 199.50
M3213-R14-C02	<b>Deluxe Display Incls Keyless Ignition</b>	\$498.00	30.0%	\$ 348.60

Part Number	Factory Installed Track Options Description	SLP in US\$	Discount Percent	Price
M3213-R02-C02	<b>Steel Tracks</b> Increases operating weight by 77 lbs	\$2,683.00	30.0%	\$ 1,878.10

Part Number	Compact Excavator Description	SLP in US\$	Discount Percent	Price
M3215	<b>E45 Compact Excavator (equipped with Final Tier 4 engine)</b>	\$59,763.00	30.0%	\$ 41,834.10

M3219

**E50 Compact Excavator (equipped with Final Tier 4 engine)**

\$66,672.00

30.0%

\$ 46,670.40



Part Number	Air Conditioned/Heated Cab Packages Description	SLP in US\$	Discount Percent	Price
M___-P01-A96	A96 Option Package	\$15,101.00	30.0%	\$ 10,570.70
M___-P01-A91	A91 Option Package	\$14,626.00	30.0%	\$ 10,238.20
M___-P01-A76	A76 Option Package	\$10,292.00	30.0%	\$ 7,204.40
M___-P01-A71	A71 Option Package	\$9,807.00	30.0%	\$ 6,864.90
M___-P01-A51	A51 Option Package	\$7,681.00	30.0%	\$ 5,376.70
M___-P01-A31	A31 Option Package	\$6,234.00	30.0%	\$ 4,363.80

<u>A31</u>	<u>A71**</u>	<u>A76**</u>	<u>A91</u>	<u>A96</u>
Enclosed Cab with Heat/AC	Enclosed Cab with Heat/AC	Enclosed Cab w/Heater-AC	Enclosed Cab with Heat/AC	Enclosed Cab with Heat/AC
Deluxe Cloth Suspension Seat	Deluxe Cloth Suspension Seat	Dlx Cloth Suspension Seat	Dlx Cloth Suspension Seat	Dlx Cloth Suspension Seat
	Hydraulic X-Change	Hydraulic X-Change	Hydraulic X-Change	Hydraulic X-Change
	Hydraulic Clamp (Class IV)	Pro-Clamp System (Class IV)	Hydraulic Clamp (Class IV)	Pro-Clamp System (Class IV)
			Second Auxiliary Hydrs	Second Auxiliary Hydrs
			Hydraulic Angle Blade	Hydr Angle Blade
			Travel Motion Alarm	Travel Motion Alarm
			Dlx Panel w/Keyless Ignition	Dlx Panel w/Keyless Ignition
			Radio	Radio

Part Number	Open Cab Packages Description	SLP in US\$	Discount Percent	Price
M___-P01-O76	O76 Option Package	\$4,364.00	30.0%	\$ 3,054.80
M___-P01-O71	O71 Option Package	\$3,879.00	30.0%	\$ 2,715.30
M___-P01-O51	O51 Option Package	\$1,569.00	30.0%	\$ 1,098.30

<u>O51</u>	<u>O71**</u>	<u>O76</u>
------------	--------------	------------

Hydraulic X-Change

Hydraulic X-Change  
Hydraulic Clamp (Class IV)

Hydraulic X-Change  
Pro-Clamp (Class IV)

NOTE: When adding an Extendable Arm Option to the O71 & A71 Pkg, Secondary Hydraulics is required to be ordered. Pro Clamp is not compatible with Ext Arm

Part Number	Factory Installed Arm Options Description	SLP in US\$	Discount Percent	Price
M3215-R03-C03	<b>Extendable Arm &amp; Counterweight (E45 Only)</b> Increases operating weight by 731 lbs. Pro-Clamp not compatible	\$5,697.00	30.0%	\$ 3,987.90
M____-R03-C02	<b>Long Arm &amp; Counterweight</b> Increases operating weight by - 476 lbs (E45), 518 lbs (E50)	\$2,033.00	30.0%	\$ 1,423.10

Part Number	Factory Installed Options Description	SLP in US\$	Discount Percent	Price
M____-R12-C02	<b>Hydraulic Angle Blade</b> Increases operating weight by 346 lbs	\$2,775.00	30.0%	\$ 1,942.50
M____-R04-C02	<b>Keyless Ignition</b>	\$203.00	30.0%	\$ 142.10
M3215-R08-C03	<b>Hydraulic Clamp - E45 - Available for Std, Long and Ext Arm</b> Second Auxiliary Hydraulics are required when ordering both the Hydraulic Clamp and Extendable Arm from the factory.	\$2,430.00	30.0%	\$ 1,701.00
M3219-R08-C03	<b>Hydraulic Clamp - E50 - Available for Std and Long</b>	\$2,430.00	30.0%	\$ 1,701.00
M3215-R08-C12	<b>Pro Clamp - E45 - Available for Std Arm and Long Arm Only</b> Includes Pro Clamp base and Material Clamp	\$2,930.00	30.0%	\$ 2,051.00
M3219-R08-C12	<b>Pro Clamp - E50 - Available for Std Arm and Long Arm Only</b> Includes Pro Clamp base and Material Clamp	\$2,930.00	30.0%	\$ 2,051.00
M____-R26-C02	<b>Radio</b>	\$397.00	30.0%	\$ 277.90
M____-R07-C02	<b>Second Auxiliary Hydraulics</b>	\$1,366.00	30.0%	\$ 956.20
M____-R11-C02	<b>Travel Motion Alarm</b>	\$285.00	30.0%	\$ 199.50
M____-R14-C02	<b>Deluxe Display Incls Keyless Ignition</b>	\$498.00	30.0%	\$ 348.60

Part Number	Factory Installed Track Options Description	SLP in US\$	Discount Percent	Price
M____-R02-C02	<b>Steel Tracks</b> Increases operating weight by 289 lbs	\$2,683.00	30.0%	\$ 1,878.10

Part Number	Compact Excavator Description	SLP in US\$	Discount Percent	Price
-------------	-------------------------------	-------------	------------------	-------



M3221

**E55 Compact Excavator (equipped with Final Tier 4 engine)\***

\$75,688.00

30.0%

\$ 52,981.60



Part Number	Air Conditioned/Heated Cab Packages Description	SLP in US\$	Discount Percent	Price
M3221-P01-A96	A96 Option Package	\$9,382.00	30.0%	\$ 6,567.40
M3221-P01-A91	A71 Option Package	\$8,906.00	30.0%	\$ 6,234.20
M3221-P01-A76	A76 Option Package	\$4,364.00	30.0%	\$ 3,054.80
M3221-P01-A71	A71 Option Package	\$3,879.00	30.0%	\$ 2,715.30
M3221-P01-A51	A51 Option Package	\$1,569.00	30.0%	\$ 1,098.30

**\*NOTE: E55 is standard with Enclosed Cab with Heat/AC and Deluxe Cloth Suspension Seat**

**A51**

Hydraulic X-Change

**A71 \*\***

Hydraulic X-Change

Hydraulic Clamp (Class IV)

**A76\*\***

Hydraulic X-Change

Pro-Clamp System (Class IV)

**A91**

Hydraulic X-Change

Hydraulic Clamp (Class IV)

Second Auxiliary Hydr

Hydraulic Angle Blade

Dlx Panel w/Keyless Ignition

Travel Motion Alarm

Radio

**A96**

Hydraulic X-Change

Pro-Clamp (Class IV)

Second Auxiliary Hydr

Hydraulic Angle Blade

Dlx Panel w/Keyless

Travel Motion Alarm

Radio

**\*\*NOTE: When adding an Extendable Arm Option to the A71 Opt Pkg, Secondary Auxiliary Hydraulics will be required to be ordered. Pro Clamp is not compatible with Ext Arm**

Part Number	Factory Installed Arm Options Description	SLP in US\$	Discount Percent	Price
M3221-R03-C03	Extendable Arm Increases operating weight by 331 lbs. Pro-Clamp is not compatible	\$5,897.00	30.0%	\$ 4,127.90

Part Number	Factory Installed Options Description	SLP in US\$	Discount Percent	Price
M3221-R12-C12	<b>Hydraulic Angle Blade</b> Increases operating weight by 346 lbs	\$2,775.00	30.0%	\$ 1,942.50
M3221-R04-C02	<b>Keyless Ignition</b>	\$203.00	30.0%	\$ 142.10
M3221-R08-C04	<b>Hydraulic Clamp for Standard Arm</b>	\$2,430.00	30.0%	\$ 1,701.00
M3221-R08-C10	<b>Hydraulic Clamp for Exntendable Arm</b> Secondary Auxiliary Hydraulics are required	\$2,430.00	30.0%	\$ 1,701.00
M3221-R08-C13	<b>Pro Clamp System (Class IV) - Available for Std Arm Only</b> Includes Pro Clamp Base and Material Clamp	\$2,930.00	30.0%	\$ 2,051.00
M3221-R26-C02	<b>Radio</b>	\$397.00	30.0%	\$ 277.90
M3221-R07-C02	<b>Second Auxiliary Hydraulics</b>	\$1,366.00	30.0%	\$ 956.20
M3221-R11-C02	<b>Travel Motion Alarm</b>	\$285.00	30.0%	\$ 199.50
M3221-R14-C02	<b>Deluxe Display Incls Keyless Ignition</b>	\$498.00	30.0%	\$ 348.60

Part Number	Factory Installed Track Options Description	SLP in US\$	Discount Percent	Price
M3221-R02-C02	<b>Steel Tracks</b> Increases operating weight by 289 lbs	\$2,683.00	30.0%	\$ 1,878.10

Part Number	Compact Excavator Description	SLP in US\$	Discount Percent	Price
M5563	<b>E63 Compact Excavator (equipped with Tier 4 engine)</b>	\$82,628.00	24.0%	\$ 62,797.28



Part Number	Factory Installed Track Options Description	SLP in US\$	Discount Percent	Price
-------------	---	-------------	------------------	-------

M5563-R02-C02

Steel Tracks

\$1,030.00

24.0%

\$

782.80

Increases operating weight by 330 lbs.

Part Number	Compact Excavator Description	SLP in US\$	Discount Percent	Price
M5583	E85 Compact Excavator (equipped with Tier 4 Engine)	\$103,927.00	24.0%	\$ 78,984.52



Part Number	Factory Installed Track Options Description	SLP in US\$	Discount Percent	Price
M5583-R02-C02	Steel Tracks Increases operating weight by 330 lbs.	\$1,030.00	24.0%	\$ 782.80



Part Number	Augers Description	SLP in US\$	Discount Percent	Labor	Price
-------------	--------------------	-------------	------------------	-------	-------



Auger Interface

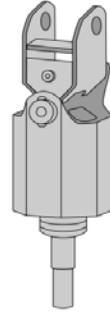

Auger Drive Unit

(E26, 324, E20)

6808799

**Model 10 Auger Drive Unit**

(If installing on a 322, must order bit, 322 Bolt-On X-Change, and interface listed below.  
If installing on a E26 or E20 equipped with X-Change, must order bit and interface listed below.)

\$1,305.00      24.0%      \$0.00      \$991.80

(E26, E32i, E32, E35i, E35, E42, E45, E50, E55, E63)

6809442

**Model 15C Auger Drive Unit**

(Must order Bit and if installing auger on an X-Change equipped excavator, must also order the interface P/N 6817100 listed below.)

(Auger drive unit is shipped with a 7/8" round bit retention pin, if used in conjunction with a hex bit a 5/8" Pin Kit P/N 6809733 is required.)

\$1,580.00      24.0%      \$0.00      \$1,200.80

7145345

**Model 15H Auger Hex Drive Unit**

(Must order Bit and if installing auger on an X-Change equipped excavator, must also order the interface P/N 6817100 listed below.)

\$1,580.00      24.0%      \$0.00      \$1,200.80

(E26, E32i, E32, E35i, E35, E42, E45, E50, E55, E63, E80, E85)

6809445

**Model 30C Auger Drive Unit**

(Must order Bit and if installing auger on an X-Change equipped excavator, must also order the interface P/N 6817100 OR 7169329 listed below.)

(Auger drive unit is shipped with a 7/8" round bit retention pin, if used in conjunction with a hex bit a 5/8" Pin Kit P/N 6809733 is required.)

\$2,120.00      24.0%      \$0.00      \$1,611.20

7138264	<b>Model 30H Auger Hex Drive Unit</b> (Must order Bit and if installing auger on an X-Change equipped excavator, must also order the interface P/N <b>6817100 OR 7169329</b> listed below.)	<b>\$2,120.00</b>	<b>24.0%</b>	<b>\$0.00</b>	<b>\$1,611.20</b>
---------	--	-------------------	--------------	---------------	-------------------

**NOTE: If using with E45, E50 and E55 Long Arm Excs, must order additional Hoses - PN 7214499 - Qty of 2**

(E42, E45, E50, E55, E63, E85)

7220280	<b>Model 35PH Auger Drive Unit</b> (Must order Bit and if installing auger on an X-Change equipped excavator, must also order the interface P/N <b>6817100 OR 7169329</b> listed below.)  (Auger drive unit is shipped with a 7/8" round bit retention pin, if used in conjunction with a hex bit a 5/8" Pin Kit P/N 6809733 is required.)	<b>\$3,220.00</b>	<b>24.0%</b>	<b>\$0.00</b>	<b>\$2,447.20</b>
---------	---	-------------------	--------------	---------------	-------------------

(E42, E45, E50, E55, E63, E85)

7227984	<b>Model 50PH Auger Hex Drive Unit</b> (Must order Bit and if installing auger on an X-Change equipped excavator, must also order the interface P/N <b>6817100 OR 7169329</b> listed below.)	<b>\$3,765.00</b>	<b>24.0%</b>	<b>\$0.00</b>	<b>\$2,861.40</b>
---------	---	-------------------	--------------	---------------	-------------------

Part Number	Accessories Description	SLP in US\$	Discount Percent	Labor	Price
6817100	X-Change Auger Interface, E20 - E55, E63	\$295.00	24.0%	\$0.00	\$224.20
7169329	E80/E85 Mounting Frame	\$735.00	24.0%	\$0.00	\$558.60

**Auger Drive & Bit Recommendations**

**Model 10 Augers on E20/E26 Excavators—Recommended bit size 6" – 36"**

**Model 15C/15H & 30C/30H Augers on E26-435, E32i-E55, E63, E85 Excavators—Recommended bit size 6"-36"**

**Model 35PH/50PH Augers—Recommended bit size - HD - 8", 12", 18", 24", 30", 36", 48" And Rock Bits - 8", 12", 18", 24", 30"**

**Auger bit combinations should be used as a guideline. Recommendations are based upon average digging conditions.**

Part Number	Breaker, Hydraulic Description	SLP in US\$	Discount Percent	Labor	Price
-------------	--------------------------------	-------------	------------------	-------	-------





Part Number	HB280 Breaker Description	SLP in US\$	Discount Percent	Labor	Price
(418) 7133202	<b>HB280 Breaker</b> (Includes Nail Point, gauge tool, retainer clip and hose protector) (Must also order hose kit and mounting cap)	\$4,535.00	24.0%	\$0.00	\$3,446.60

Accessories – HB280

7170566	<b>Hose Kit - 418</b>	\$180.00	24.0%	\$0.00	\$136.80
7160677	<b>Pin-On Mounting Cap - 418</b>	\$90.00	24.0%	\$0.00	\$68.40

Part Number	HB680 Breaker Description	SLP in US\$	Discount Percent	Labor	Price
-------------	---------------------------	-------------	------------------	-------	-------

(E26) 7113419	<b>HB680 Breaker</b> (Includes Nail Point, fixing cap bolts, cradle, isolation mount, gauge tool, retainer clip and hose protector) (Must also order X-Change Mounting Frame and Hose Kit)	\$4,430.00	24.0%	\$0.00	\$3,366.80
------------------	---	------------	-------	--------	------------

Mounting Frames – HB680

7117752	<b>Pin-On Mounting Cap – E20</b> (Must also order a hose kit, P/N 7117823)	\$280.00	24.0%	\$0.00	\$212.80
7113656	<b>X-Change Mounting Cap – E26</b> (Must also order a hose kit, P/N 7117823 or 7117832)	\$410.00	24.0%	\$0.00	\$311.60

Accessories – HB680

7117823	<b>Hose Kit – E20, E26</b> (Includes hoses and quick couplers)	\$195.00	24.0%	\$0.00	\$148.20
7117832	<b>Hose Kit – E26 Long Arm</b> (Includes hoses and quick couplers)	\$195.00	24.0%	\$0.00	\$148.20

Part Number	HB880 Breaker Description	SLP in US\$	Discount Percent	Labor	Price
-------------	---------------------------	-------------	------------------	-------	-------

(E32i, E32, E35i, E35)

7113420	<b>HB880 Breaker</b> (Includes Nail Point, fixing cap bolts, cradle, isolation mount, gauge tool, retainer clip and hose protector) (Must also order X-Change Mounting Cap and Hose Kit) (Must also order Auxiliary Hydraulics p/n 7126596 if using with 329 excavator)	\$6,275.00	24.0%	\$0.00	\$4,769.00
---------	---	------------	-------	--------	------------

**Mounting Frame – HB880**

7113657	<b>X-Change Mounting Cap</b> (Must also order a hose kit)	\$410.00	24.0%	\$0.00	\$311.60
---------	--	----------	-------	--------	----------

**Accessories - HB880**

6728963	<b>Hose Kit - E32, E35, 325 Long Arm, E28</b> (Includes hoses and quick couplers)	\$195.00	24.0%	\$0.00	\$148.20
7180019	<b>Hose Kit - E32 Long Arm, E35 Long Arm</b> (Includes hoses and quick couplers)	\$235.00	24.0%	\$0.00	\$178.60

Part Number	HB980 Breaker Description	SLP in US\$	Discount Percent	Labor	Price
-------------	---------------------------	-------------	------------------	-------	-------

(E32i, E32, E35i, E35, E42, E45, E50)

7113421	<b>HB980 Breaker</b> (Includes Nail Point, fixing cap bolts, cradle, isolation mount, gauge tool, retainer clip and hose protector) (Must also order X-Change Mounting Cap and Hose Kit) (Must also order Auxiliary Hydraulics p/n 7126596 if using with 329 excavator)	\$7,860.00	24.0%	\$0.00	\$5,973.60
---------	---	------------	-------	--------	------------

**Mounting Frame –HB980**

7113657	<b>X-Change Mounting Cap</b> (Must also order a hose kit)	\$410.00	24.0%	\$0.00	\$311.60
---------	--	----------	-------	--------	----------

**Accessories –HB980**

6728967	<b>Hose Kit - E42, E50 Long Arm, E55 Long Arm</b> (Includes hoses and quick couplers)	\$195.00	24.0%	\$0.00	\$148.20
6728963	<b>Hose Kit - E32,E35</b> (Includes hoses and quick couplers)	\$195.00	24.0%	\$0.00	\$148.20
7180019	<b>Hose Kit - E32,E35,E42,E45 - All with Long Arm</b> (Includes hoses and quick couplers)	\$235.00	24.0%	\$0.00	\$178.60
7114762	<b>Hose Kit - E42,E45,E50</b> (Includes hoses and quick couplers)	\$195.00	24.0%	\$0.00	\$148.20

Part Number	HB1180 Breaker Description	SLP in US\$	Discount Percent	Labor	Price
-------------	----------------------------	-------------	------------------	-------	-------



(E42, E45, E50, E55, E60\*, E63, E80, E85)

7115923	<b>HB1180 Breaker</b> (Includes Nail Point, fixing cap bolts, cradle, isolation mount, gauge tool, retainer clip and hose protector) (Must also order X-Change Mounting Cap and Hose Kit) <b>*Approved for use with E60, SN AGSZ11321 &amp; Above</b>	\$10,335.00	24.0%	\$0.00	\$7,854.60
---------	---	-------------	-------	--------	------------

Mounting Frame –HB1180

(E42, E45, E50, E55, E60, E63, E85)

7117325	<b>X-Change Mounting Cap</b> (Must also order a hose kit)	\$555.00	24.0%	\$0.00	\$421.80
---------	--	----------	-------	--------	----------

(E80, E85)

7168502	<b>Pin-On Mounting Cap</b> (Must also order a hose kit, P/N 7130290)	\$720.00	24.0%	\$0.00	\$547.20
---------	---	----------	-------	--------	----------

Accessories –HB1180

7114762	<b>Hose Kit-E42, E45, E50</b>	\$195.00	24.0%	\$0.00	\$148.20
6728967	<b>Hose Kit – E50 - All with long arm, E55</b>	\$195.00	24.0%	\$0.00	\$148.20
7180019	<b>Hose Kit – E42, E45 – all with long arm</b>	\$235.00	24.0%	\$0.00	\$178.60
7176608	<b>Hose Kit – E63 , E85</b>	\$275.00	24.0%	\$0.00	\$209.00

Part Number	HB1380 Breaker Description	SLP in US\$	Discount Percent	Labor	Price
-------------	----------------------------	-------------	------------------	-------	-------

(E63, E85)

7157576	<b>HB1380 Breaker</b> (Includes Nail Point, fixing cap bolts, cradle, isolation mount, gauge tool, retainer clip and hose protector) (Must also order Loader Mounting Frame and Hose Kit) (Special Applications Kit must be used when operating a Hydraulic Breaker) <b>*Approved for use with E60, SN AGSZ11321 &amp; Above</b>	\$12,825.00	24.0%	\$0.00	\$9,747.00
---------	---	-------------	-------	--------	------------

Mounting Frame –HB1380

(E63)

7117325	<b>X-Change Mounting Cap</b> (Must also order a hose kit, P/N 7176608)	\$555.00	24.0%	\$0.00	\$421.80
---------	---	----------	-------	--------	----------

(E85)

7168502	<b>Pin-On Mounting Cap</b> (Must also order a hose kit, P/N 7176608)	\$720.00	24.0%	\$0.00	\$547.20
---------	---	----------	-------	--------	----------

Accessories – HB1380

7176608	<b>Hose Kit E63, E85</b> (Includes hoses and quick couplers)	\$275.00	24.0%	\$0.00	\$209.00
---------	---	----------	-------	--------	----------

Part Number	HB2380 Breaker Description	SLP in US\$	Discount Percent	Labor	Price
-------------	----------------------------	-------------	------------------	-------	-------

(E85) 7133203	<b>HB2380 Breaker</b> (Includes Nail Point, fixing cap bolts, cradle, isolation mount, and hose protector) (Must also order Pin-On Mounting Cap and Hose Kit)	\$15,760.00	24.0%	\$0.00	\$11,977.60
------------------	---	-------------	-------	--------	-------------

Mounting Frames –HB2380

(E85) 7168502	<b>Pin-On Mounting Cap</b> (Must also order a hose kit, P/N 7176608)	\$720.00	24.0%	\$0.00	\$547.20
------------------	---	----------	-------	--------	----------

Accessories – HB2380

7176608	<b>Hose Kit- E85</b> (Includes hoses and quick couplers)	\$275.00	24.0%	\$0.00	\$209.00
---------	---	----------	-------	--------	----------

Part Number	Buckets Description	SLP in US\$	Discount Percent	Labor	Price
-------------	---------------------	-------------	------------------	-------	-------

(418 Pin-On Style) 7157626	<b>8" Trenching Bucket with Teeth</b>	\$380.00	24.0%	\$0.00	\$288.80
7140493	<b>12" Trenching Bucket with Teeth</b>	\$415.00	24.0%	\$0.00	\$315.40
7140489	<b>16" Trenching Bucket with Teeth</b>	\$430.00	24.0%	\$0.00	\$326.80
7150275	<b>31" Grading Bucket, No Teeth</b>	\$515.00	24.0%	\$0.00	\$391.40

(E20) 6715495	<b>9" Trenching Bucket, 2 Bolt-On Teeth</b>	\$420.00	24.0%	\$0.00	\$319.20
6715496	<b>12" Trenching Bucket, 3 Bolt-On Teeth</b>	\$465.00	24.0%	\$0.00	\$353.40
6715497	<b>16" Trenching Bucket, 3 Bolt-On Teeth</b>	\$510.00	24.0%	\$0.00	\$387.60
7109522	<b>18" Trenching Bucket, 4 Bolt-On Teeth</b>	\$525.00	24.0%	\$0.00	\$399.00
6715498	<b>20" Trenching Bucket, 4 Bolt-On Teeth</b>	\$555.00	24.0%	\$0.00	\$421.80
6715499	<b>39" Grading Bucket, No Teeth</b>	\$585.00	24.0%	\$0.00	\$444.60

Note: The 9"- 18" buckets are the same buckets as used with the 406 Backhoe.

(E26)

6735375	13" Trenching Bucket, 3 Bolt-On Teeth	\$590.00	24.0%	\$0.00	\$448.40
6735380	16" Trenching Bucket, 4 Bolt-On Teeth	\$620.00	24.0%	\$0.00	\$471.20
6735395	20" Trenching Bucket, 4 Bolt-On Teeth	\$670.00	24.0%	\$0.00	\$509.20
6735399	24" Trenching Bucket, 5 Bolt-On Teeth	\$720.00	24.0%	\$0.00	\$547.20
6735443	39" Grading Bucket, No Teeth	\$980.00	24.0%	\$0.00	\$744.80
	Note: These buckets are the same buckets as used with the 607 Backhoe.				
6817096	55" Grading Blade	\$725.00	24.0%	\$0.00	\$551.00
<b>(E32i, E32, E35i, E35) CLASS III BUCKETS</b>					
M7024-R01-C03	12" Trenching Bucket, Smooth Lip	\$630.00	24.0%	\$0.00	\$478.80
M7024-R01-C02	12" Trenching Bucket, Severe Duty 3 Weld-on Teeth	\$815.00	24.0%	\$0.00	\$619.40
M7024-R01-C01	12" Trenching Bucket, 3 Weld-on Teeth	\$685.00	24.0%	\$0.00	\$520.60
M7031-R01-C03	16" Trenching Bucket, Smooth Lip	\$698.00	24.0%	\$0.00	\$530.48
M7031-R01-C02	16" Trenching Bucket, Severe Duty 4 Weld-on Teeth	\$880.00	24.0%	\$0.00	\$668.80
M7031-R01-C01	16" Trenching Bucket, 3 Weld-on Teeth	\$760.00	24.0%	\$0.00	\$577.60
M7023-R01-C03	18" Trenching Bucket, Smooth Lip	\$770.00	24.0%	\$0.00	\$585.20
M7023-R01-C02	18" Trenching Bucket, Severe Duty 4 Weld-on Teeth	\$960.00	24.0%	\$0.00	\$729.60
M7023-R01-C01	18" Trenching Bucket, 4 Weld-on Teeth	\$825.00	24.0%	\$0.00	\$627.00
M7027-R01-C03	20" Trenching Bucket, Smooth Lip	\$780.00	24.0%	\$0.00	\$592.80
M7027-R01-C01	20" Trenching Bucket, 4 Weld-On Teeth	\$835.00	24.0%	\$0.00	\$634.60
M7021-R01-C03	24" Trenching Bucket, Smooth Lip	\$835.00	24.0%	\$0.00	\$634.60
M7021-R01-C02	24" Trenching Bucket, Severe Duty 4 Weld-on Teeth	\$1,055.00	24.0%	\$0.00	\$801.80
M7021-R01-C01	24" Trenching Bucket, 4 Weld-on Teeth	\$885.00	24.0%	\$0.00	\$672.60
M7028-R01-C03	30" Trenching Bucket, Smooth Lip	\$887.00	24.0%	\$0.00	\$674.12
M7028-R01-C01	30" Trenching Bucket, 5 Weld-On Teeth	\$1,000.00	24.0%	\$0.00	\$760.00
M7029-R01-C02	36" Trenching Bucket, Smooth Lip	\$940.00	24.0%	\$0.00	\$714.40
M7029-R01-C01	36" Trenching Bucket, 6 Weld-on Teeth	\$1,095.00	24.0%	\$0.00	\$832.20
6735443	39" Grading Bucket, No Teeth	\$980.00	24.0%	\$0.00	\$744.80
	Note: This bucket are the same buckets as used with the 709 & 8811 Backhoes.				
6817096	55" Grading Blade	\$725.00	24.0%	\$0.00	\$551.00
<b>(E42 "Standard" Buckets) CLASS III BUCKETS</b>					
M7024-R01-C02	12" Severe Duty Trenching Bucket, 3 Weld-On Teeth	\$815.00	24.0%	\$0.00	\$619.40

M7031-R01-C02	16" Severe Duty Trenching Bucket, 4 Weld-On Teeth	\$880.00	24.0%	\$0.00	\$668.80
M7023-R01-C02	18" Severe Duty Trenching Bucket, 4 Weld-On Teeth	\$960.00	24.0%	\$0.00	\$729.60
M7021-R01-C02	24" Severe Duty Trenching Bucket, 4 Weld-On Teeth	\$1,055.00	24.0%	\$0.00	\$801.80
<b>(E42, E45, E50, E55, E63) CLASS IV BUCKETS</b>					
M7025-R01-C03	12" Trenching Bucket, Smooth Lip	\$815.00	24.0%	\$0.00	\$619.40
M7025-R01-C02	12" Severe Duty Trenching Bucket, 3 Weld-On Teeth	\$900.00	24.0%	\$0.00	\$684.00
M7025-R01-C01	12" Trenching Bucket, 3 Weld-on Teeth	\$830.00	24.0%	\$0.00	\$630.80
M7030-R01-C03	18" Trenching Bucket, Smooth Lip	\$920.00	24.0%	\$0.00	\$699.20
M7030-R01-C02	18" Severe Duty Trenching Bucket, 4 Weld-On Teeth	\$1,080.00	24.0%	\$0.00	\$820.80
M7030-R01-C01	18" Trenching Bucket, 4 Weld-on Teeth	\$1,005.00	24.0%	\$0.00	\$763.80
M7022-R01-C03	24" Trenching Bucket, Smooth Lip	\$1,025.00	24.0%	\$0.00	\$779.00
M7022-R01-C02	24" Severe Duty Trenching Bucket, 4 Weld-On Teeth	\$1,255.00	24.0%	\$0.00	\$953.80
M7022-R01-C01	24" Trenching Bucket, 4 Weld-on Teeth	\$1,105.00	24.0%	\$0.00	\$839.80
M7026-R01-C03	30" Trenching Bucket, Smooth Lip	\$1,142.00	24.0%	\$0.00	\$867.92
M7026-R01-C02	30" Trenching Bucket, Severe Duty, with 5 Weld-on Teeth	\$1,402.00	24.0%	\$0.00	\$1,065.52
M7026-R01-C01	30" Trenching Bucket, with 5 Weld-on Teeth	\$1,215.00	24.0%	\$0.00	\$923.40
M7020-R01-C03	36" Trenching Bucket, Smooth Lip	\$1,255.00	24.0%	\$0.00	\$953.80
M7020-R01-C02	36" Trenching Bucket, Severe Duty, with 6 Weld-on Teeth	\$1,504.00	24.0%	\$0.00	\$1,143.04
M7020-R01-C01	36" Trenching Bucket, 6 Weld-on Teeth	\$1,345.00	24.0%	\$0.00	\$1,022.20
6735443	39" Grading Bucket, No Teeth (Not approved with E42, E45, E50, E55 or E60)	\$980.00	24.0%	\$0.00	\$744.80
6735370	52" Grading Bucket, No Teeth	\$1,205.00	24.0%	\$0.00	\$915.80
6817096	55" Grading Blade	\$725.00	24.0%	\$0.00	\$551.00
<b>( E85- Pin-On Buckets)</b>					
7171895	18" Trenching Bucket, with 3 Weld-On Teeth	\$1,120.00	24.0%	\$0.00	\$851.20
7171893	24" Trenching Bucket, with 4 Weld-On Teeth	\$1,280.00	24.0%	\$0.00	\$972.80
7171897	36" Trenching Bucket, with 5 Weld-On Teeth	\$1,605.00	24.0%	\$0.00	\$1,219.80
7171899	54" Grading Bucket, No Teeth	\$2,015.00	24.0%	\$0.00	\$1,531.40
7171901	48" Tilting Grade Bucket, No Teeth	\$7,485.00	24.0%	\$0.00	\$5,688.60

Part Number	Clamp, Hydraulic Description	SLP in US\$	Discount Percent	Labor	Price
-------------	------------------------------	-------------	------------------	-------	-------

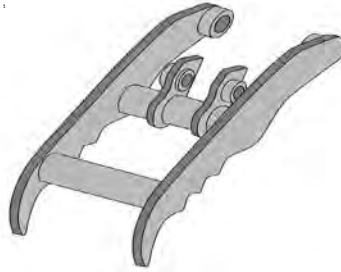

**Hydraulic Clamp is NOT recommended in combination with Hydraulic Breakers**

**(E26) CLASS III**

<b>7206504</b>	<b>Hydraulic Clamp, standard arm</b> (Incls cylinder, hoses & pins) <i>(Price includes \$225 for installation)</i>	<b>\$1,785.00</b>	<b>24.0%</b>	<b>\$225.00</b>	<b>\$1,581.60</b>
----------------	---	-------------------	--------------	-----------------	-------------------

<b>7206505</b>	<b>Hydraulic Clamp, long arm</b> (Incls cylinder, hoses & pin) <i>(Price includes \$225 for installation)</i>	<b>\$1,785.00</b>	<b>24.0%</b>	<b>\$225.00</b>	<b>\$1,581.60</b>
----------------	--	-------------------	--------------	-----------------	-------------------

**(E32i, E32, E35i, E35) CLASS III**

<b>7171388</b>	<b>Hydraulic Clamp, standard arm</b> (Incls cylinder, hoses & pins) (Includes cylinder, hoses & pins) <i>(Price includes \$225 for installation)</i>	<b>\$1,920.00</b>	<b>24.0%</b>	<b>\$225.00</b>	<b>\$1,684.20</b>
----------------	--	-------------------	--------------	-----------------	-------------------

<b>7171389</b>	<b>Hydraulic Clamp, long arm</b> (Incls cylinder, hoses & pin) (Includes cylinder, hoses & pins) <i>(Price includes \$225 for installation)</i>	<b>\$1,920.00</b>	<b>24.0%</b>	<b>\$225.00</b>	<b>\$1,684.20</b>
----------------	---	-------------------	--------------	-----------------	-------------------

<b>7203200</b>	<b>Hydraulic Clamp, Extendable arm</b> (Incls cylinder, hoses & pins) (The Hydraulic Clamp is approved for use with the extendable arm extended) <i>(Price includes \$225 for installation)</i>	<b>\$1,920.00</b>	<b>24.0%</b>	<b>\$225.00</b>	<b>\$1,684.20</b>
----------------	---	-------------------	--------------	-----------------	-------------------

**(E42) CLASS III**

<b>7182692</b>	<b>Hydraulic Clamp, standard arm</b> (incls cylinder, hoses & pins) <i>(Price includes \$225 for installation)</i>	<b>\$2,020.00</b>	<b>24.0%</b>	<b>\$225.00</b>	<b>\$1,760.20</b>
----------------	---	-------------------	--------------	-----------------	-------------------

<b>7182693</b>	<b>Hydraulic Clamp, long arm</b> (incls cylinder, hoses & pins) <i>(Price includes \$225 for installation)</i>	<b>\$2,020.00</b>	<b>24.0%</b>	<b>\$225.00</b>	<b>\$1,760.20</b>
----------------	---	-------------------	--------------	-----------------	-------------------

**(E42, E45) CLASS IV**

<b>7186614</b>	<b>Hydraulic Clamp, standard arm</b> (Incls cylinder, hoses & pins)	<b>\$2,330.00</b>	<b>24.0%</b>	<b>\$225.00</b>	<b>\$1,995.80</b>
----------------	---	-------------------	--------------	-----------------	-------------------

(Price includes \$225 for installation)

7186615	<b>Hydraulic Clamp, long arm</b> (Incls cylinder, hoses & pins) (Price includes \$225 for installation)	\$2,330.00	24.0%	\$225.00	\$1,995.80
7221951	<b>Hydraulic Clamp, Extendable arm</b> (Incls cylinder, hoses & pins) (Price includes \$225 for installation)	\$2,330.00	24.0%	\$225.00	\$1,995.80
<b>(E50) CLASS IV</b>					
7182661	<b>Hydraulic Clamp, Std Arm</b> (Incls cylinder, hoses & pins) (Price includes \$225 for installation)	\$2,430.00	24.0%	\$225.00	\$2,071.80
7182663	<b>Hydraulic Clamp, Long arm</b> (Incls cylinder, hoses & pins) (Price includes \$225 for installation)	\$2,430.00	24.0%	\$225.00	\$2,071.80
<b>(E55) CLASS IV</b>					
7182663	<b>Hydraulic Clamp,</b> (Incls cylinder, hoses & pins) (Price includes \$225 for installation)	\$2,430.00	24.0%	\$225.00	\$2,071.80
7221950	<b>Hydraulic Clamp, Extendable Arm</b> (Incls cylinder, hoses & pins) (Price includes \$225 for installation)	\$2,430.00	24.0%	\$225.00	\$2,071.80
<b>(E63)</b>					
7187919	<b>Hydraulic Clamp,</b> (Incls cylinder, hoses & pins) (Price includes \$225 for installation)	\$2,710.00	24.0%	\$225.00	\$2,284.60
<b>(E85)</b>					
7171909	<b>Hydraulic Clamp</b> (Incls cylinder, hoses & pins) (Price includes \$225 for installation)	\$3,895.00	24.0%	\$225.00	\$3,185.20

Part Number	Pro Clamp System Description	SLP in US\$	Discount Percent	Labor	Price
-------------	------------------------------	-------------	------------------	-------	-------

<b>(E32i, E32, E35i, E35) CLASS III</b>					
7221006	<b>Pro Clamp System Kit for Standard Arm</b> (Not compatible with Ext Arm) (Includes cylinder, hoses & pins, Pro Clamp and Material Clamp) (Price includes \$225 for installation)	\$2,420.00	24.0%	\$225.00	\$2,064.20
7221011	<b>Pro Clamp System Kit for Long Arm</b> (Not compatible with Ext Arm) (Includes cylinder, hoses & pins, Pro Clamp and Material Clamp) (Price includes \$225 for installation)	\$2,420.00	24.0%	\$225.00	\$2,064.20

(E42, E45) CLASS IV

7240479 **Pro Clamp System Kit for Standard Arm** (Not compatible with Ext Arm) **\$2,900.00** **24.0%** **\$225.00** **\$2,429.00**

(Includes cylinder, hoses & pins, Pro Clamp and Material Clamp)

(Price includes \$225 for installation)

7240481 **Pro Clamp System Kit for Long Arm** (Not compatible with Ext Arm) **\$2,900.00** **24.0%** **\$225.00** **\$2,429.00**

(Includes cylinder, hoses & pins, Pro Clamp and Material Clamp)

(Price includes \$225 for installation)

(E50) CLASS IV

7240475 **Pro Clamp System Kit for Standard Arm** **\$2,900.00** **24.0%** **\$225.00** **\$2,429.00**

(Includes cylinder, hoses & pins, Pro Clamp and Material Clamp)

(Price includes \$225 for installation)

7240477 **Pro Clamp System Kit for Long Arm** **\$2,900.00** **24.0%** **\$225.00** **\$2,429.00**

(Includes cylinder, hoses & pins, Pro Clamp and Material Clamp)

(Price includes \$225 for installation)

(E55) CLASS IV

7240477 **Pro Clamp System Kit for Standard Arm** **\$2,900.00** **24.0%** **\$225.00** **\$2,429.00**

(Includes cylinder, hoses & pins, Pro Clamp and Material Clamp)

(Price includes \$225 for installation)

Part Number	Flail Mower Description	SLP in US\$	Discount Percent	Labor	Price
-------------	-------------------------	-------------	------------------	-------	-------

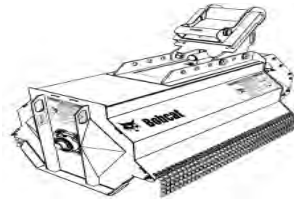

(E32, E35)  
7225484 **30" Flail Mower** **\$6,670.00** **24.0%** **\$0.00** **\$5,069.20**

(Approved only for excavator models equipped with an enclosed cab)

(Must also order a Case Drain Kit, hose kit and mounting cap)

(E42, E45, E50, E55)  
7225485 **40" Flail Mower** **\$7,415.00** **24.0%** **\$0.00** **\$5,635.40**

(Approved only for excavator models equipped with an enclosed cab)

(Must also order a Case Drain Kit, hose kit and mounting cap)

Part Number	Factory Installed Accessories for Flail Mower Description	SLP in US\$	Discount Percent	Labor	Price
-------------	---	-------------	------------------	-------	-------

Accessories for 30" Flail Mower

(E32, E35)					
7245468	<b>Hoses for Std Arm</b> (Incls Hoses and quick couplers) Must also order 7245617 and 7238337)	\$205.00	24.0%	\$0.00	\$155.80
7238337	<b>X-Change Mounting Cap</b> (Mounting cap will arrive assembled on Flail Mower) (Must order Hoses)	\$790.00	24.0%	\$0.00	\$600.40

Accessories for 40" Flail Mower

(E42, E45, E50, E55)					
7245468	<b>Hoses for Std Arm</b> (Incls Hoses and quick couplers) Must also order a Mounting Cap - And Case Drain Kit (PN 7245618 or 7246494)	\$205.00	24.0%	\$0.00	\$155.80
7245459	<b>Hoses for Long Arm</b> (Incls Hoses and quick couplers) Must also order a Mounting Cap - And Case Drain Kit (PN 7245618 or 7246494)	\$230.00	24.0%	\$0.00	\$174.80
7238337	<b>X-Change Mounting Cap</b> (Must also order a Hose Kit and Case Drain Kit)	\$790.00	24.0%	\$0.00	\$600.40
7246964	<b>Pin-On Mounting Cap</b> (Must also order a Hose Kit and Case Drain Kit)	\$790.00	24.0%	\$0.00	\$600.40

Part Number	Coupler, Pin Grabber Description	SLP in US\$	Discount Percent	Labor	Price
-------------	----------------------------------	-------------	------------------	-------	-------

(E85)					
7171904	<b>Coupler, Pin Grabber**</b> (Compatible with attachment pin spacing of 11.5 inches) (E85 to E85 attachments)	\$2,460.00	24.0%	\$0.00	\$1,869.60
7171906	<b>Coupler, Pin Grabber**</b> Compatible with attachment pin spacing of 10.8 inches) (E85 to 442 attachments)	\$2,560.00	24.0%	\$0.00	\$1,945.60

**\*\*NOTE: If used on more than one attachment, must order the following for each additional attachment:**

7004571 Pin - 2 ea

7007708 Bolt - 2 ea

7007801 Nut - 2 ea

Part Number	Grapple, 3-Tine Description	SLP in US\$	Discount Percent	Labor	Price
-------------	-----------------------------	-------------	------------------	-------	-------





(E26, E32i, E32, E35i, E35)

7102977

**3-Tine Grapple, CLASS III** (X-Chg System Required)

(Hydraulic Clamp is recommended when using 3-Tine Grapple)

**\$635.00**

**24.0%**

**\$0.00**

**\$482.60**

(E42, E45, E50, E55, E60, E63)

6817104

**3-Tine Grapple, CLASS IV** (X-Chg System Required)

(Hydraulic Clamp is recommended when using 3-Tine Grapple)

**\$680.00**

**24.0%**

**\$0.00**

**\$516.80**

Part Number	Hydra-Tilt Description	SLP in US\$	Discount Percent	Labor	Price
-------------	------------------------	-------------	------------------	-------	-------

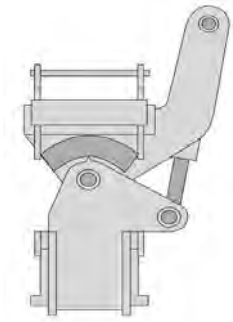

(E26, E32i, E32, E35i, E35, E42, E45, E50, E55, E60)

6728578	<b>Hydra-Tilt</b> (Must also order Hose Kit below) (Must also order Auxiliary Hydraulics p/n 7126596 if using with 329 excavator)	\$2,030.00	24.0%	\$0.00	\$1,542.80
---------	---	------------	-------	--------	------------

\*The Extendible Arm must be pinned in the retracted position to use hydraulic attachments.

Part Number	Accessories Description	SLP in US\$	Discount Percent	Labor	Price
-------------	-------------------------	-------------	------------------	-------	-------

(E26, E32i, E32, E35i, E35, E60, E63)

6729174	<b>Excavator Hose Kit</b> (This hose kit must be used on above excavators when using a Hydra-Tilt) (Price includes \$90 for installation)	\$195.00	24.0%	\$90.00	\$238.20
---------	---	----------	-------	---------	----------

(E42, E45, E50)

(E26, E32i, E32, E35i, E35, E42 E45 – All with Long Arm)

6729175	<b>Excavator Hose Kit</b> (This hose kit must be used on above excavators when using a Hydra-Tilt) (Price includes \$90 for installation)	\$195.00	24.0%	\$90.00	\$238.20
---------	---	----------	-------	---------	----------

(E50 Long Arm, E55)

6729176	<b>Excavator Hose Kit</b> (This hose kit must be used on above excavators when using a Hydra-Tilt) (Price includes \$90 for installation)	\$175.00	24.0%	\$90.00	\$223.00
---------	---	----------	-------	---------	----------

Part Number	Packer Wheel Description	SLP in US\$	Discount Percent	Labor	Price
-------------	--------------------------	-------------	------------------	-------	-------

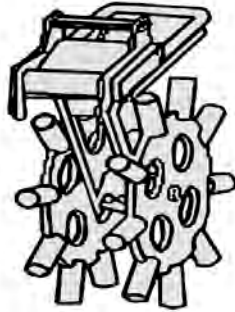

(E26, E32i, E32, E35i, E35, E42, E45, E50, E55, E60)

6806644	Packer Wheel	\$2,020.00	24.0%	\$0.00	\$1,535.20
---------	--------------	------------	-------	--------	------------

Part Number	Plate Compactor Description	SLP in US\$	Discount Percent	Labor	Price
-------------	-----------------------------	-------------	------------------	-------	-------

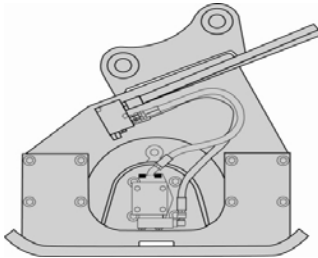

(E32i, E32, E35i, E35, E42, E45, E50, E55, E60, E63)

7211623	<b>PCF34 Plate Compactor</b>	\$4,890.00	24.0%	\$135.00	\$3,851.40
---------	------------------------------	------------	-------	----------	------------

(Must also order X-Change Mounting Cap and Hose Kit)

(E55, E60, E63, E80, E85)

7210256	<b>PCF64 Plate Compactor</b>	\$5,645.00	24.0%	\$135.00	\$4,425.20
---------	------------------------------	------------	-------	----------	------------

(Must also order Mounting Cap and Hose Kit)

Part Number	Accessories for Plate Compactor Description	SLP in US\$	Discount Percent	Labor	Price
-------------	---	-------------	------------------	-------	-------

**Mounting Frame - PCF34**

(E32i, E32, E35i, E35, E42, E45, E50, E55, E63)

7113656	X-Change Mounting Cap (Must also order hose kit)	\$410.00	24.0%	\$0.00	\$311.60
---------	--	----------	-------	--------	----------

**Mounting Frame - PCF64**

(E55, E63)

7113657	X-Change Mounting Cap (Must also order hose kit)	\$410.00	24.0%	\$0.00	\$311.60
---------	--	----------	-------	--------	----------

(E85)

7210254	Mounting Cap (Must also order hose kit)	\$625.00	24.0%	\$0.00	\$475.00
---------	---	----------	-------	--------	----------

**Hose Kits for PCF34 and PCF64 Plate Compactors**

(All Long Arm Excs and E55)

7217834	Hose Kit (Incls hoses and quick couplers)	\$195.00	24.0%	\$0.00	\$148.20
---------	---	----------	-------	--------	----------

(All Std Arm Excs) (not including E63, E85)

7217835	Hose Kit (Incls hoses and quick couplers)	\$185.00	24.0%	\$0.00	\$140.60
---------	---	----------	-------	--------	----------

(E63, E85)

7217836	Hose Kit (Incls hoses and quick couplers)	\$275.00	24.0%	\$0.00	\$209.00
---------	---	----------	-------	--------	----------

Part Number	Power Tilt Description	SLP in US\$	Discount Percent	Labor	Price
-------------	------------------------	-------------	------------------	-------	-------

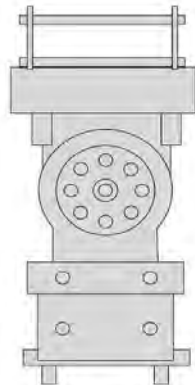

(E26, E32i, E32, E35i, E35)

6719347

**PTX3**

(Includes hoses & couplers)

\* The Extendable Arm must be pinned in the retracted position to use hydraulic attachments.

\$4,675.00

24.0%

\$0.00

\$3,553.00

(E42, E45, E50, E55, E60, E63)

6718077

**PTX4**

(Includes hoses & couplers)

\$6,200.00

24.0%

\$0.00

\$4,712.00

Part Number	Ripper Description	SLP in US\$	Discount Percent	Labor	Price
-------------	--------------------	-------------	------------------	-------	-------



(E26, E32i, E32, E35i, E35, E42, E45, E50, E55, E60, E63)

6817177

**Frost & Rock Ripper**

(Used to penetrate and scarify frost or hard ground)

(X-Change System Required)

\$950.00

24.0%

\$0.00

\$722.00

(E80, E85)

7171903

**Ripper Tooth, Pin-On**

\$1,385.00

24.0%

\$0.00

\$1,052.60

Part Number	Tilt Bucket Description	SLP in US\$	Discount Percent	Labor	Price
-------------	-------------------------	-------------	------------------	-------	-------

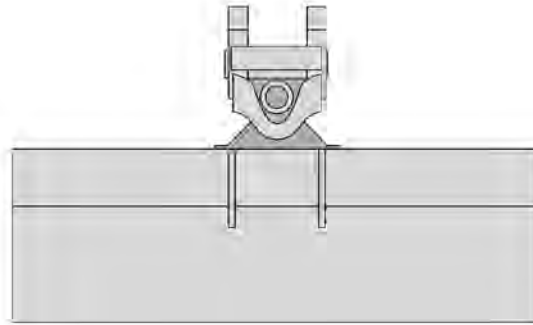

**Pin-On Bucket**

(E80, E85) 7171901	48" Tilting Grade Bucket, No Teeth	\$7,485.00	24.0%	\$0.00	\$5,688.60
-----------------------	------------------------------------	------------	-------	--------	------------

Part Number	Trencher Description	SLP in US\$	Discount Percent	Labor	Price
-------------	----------------------	-------------	------------------	-------	-------

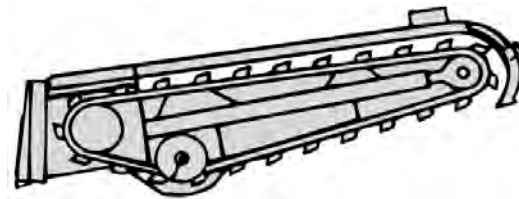

( E32, E35, E42, E45, E50, E55) M7012	<b>MX112 Trencher</b>	\$3,535.00	24.0%	\$0.00	\$2,686.60
--	-----------------------	------------	-------	--------	------------

(Includes X-Change mounting frame, hoses, couplers, 2' depth, no sideshift)  
(Can only order one chain option per trencher model)

\* The Extendable Arm must be pinned in the retracted position to use hydraulic attachments.

**MX112 Chain Configuration Options (Factory Installed)**

*Chains are 1.654" Double Standard (DS) Anti-Back Flex (ABF)*

M7012-R01-C02	2' x 4" cup teeth, Single Standard pattern	\$385.00	24.0%	\$0.00	\$292.60
M7012-R01-C01	2' x 4" Cup Teeth, Double Standard Pattern	\$485.00	24.0%	\$0.00	\$368.60
M7012-R01-C03	2' x 4" cup & carbide teeth, Double Standard pattern	\$945.00	24.0%	\$0.00	\$718.20

April 1, 2015  
BOBCAT SLP Pages



Part Number	VersaHandler Description	SLP in US\$	Discount Percent	Labor	Price
7138801	V417 VersaHandler with Cab Enclosure & 7 pin Attachment Control (Tier 3)	\$73,325.00	24.0%	\$0.00	\$55,727.00







Part Number	Angle Broom Description	SLP in US\$	Discount Percent	Labor	Price
-------------	-------------------------	-------------	------------------	-------	-------

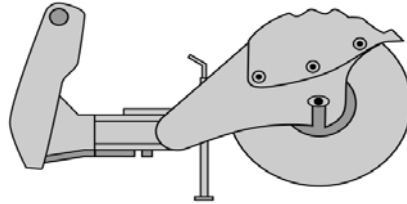

(V417 with Cab) 6905806	<b>84" Angle Broom</b> (VersaHandler must be equipped with Attachment Control Kit to operate Angle Broom)	\$6,080.00	24.0%	\$0.00	\$4,620.80
----------------------------	--	------------	-------	--------	------------

Part Number	Augers Description	SLP in US\$	Discount Percent	Labor	Price
-------------	--------------------	-------------	------------------	-------	-------

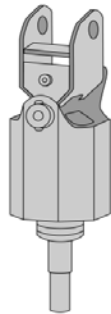

(V417) 6809442	<b>Model 15C Auger Drive Unit</b> (Must also order Mounting Frame and Bit)	\$1,580.00	24.0%	\$0.00	\$1,200.80
7145345	<b>Model 15H Hex Shaft Auger Drive Unit</b> (Must also order Mounting Frame and Bit)	\$1,580.00	24.0%	\$0.00	\$1,200.80
6809445	<b>Model 30C Auger Drive Unit</b> (Must also order Mounting Frame and Bit)	\$2,120.00	24.0%	\$0.00	\$1,611.20
7138264	<b>Model 30H Hex Shaft Auger Drive Unit</b> (Must also order Mounting Frame and Bit)	\$2,120.00	24.0%	\$0.00	\$1,611.20

(V417)

6812980

**Mounting Frame**

(Includes Mounting Hardware)

\$370.00

24.0%

\$0.00

\$281.20

**Auger Drive & Bit Recommendations (call for Pricing)**

**Model 15C and 30C Augers—Recommended bit size - 6", 9", 12", 15", 18", 24", 30", 36"**

**Model 15H and 30H Augers—Recommended bit size - 6" , 9", 12", 16", 18", 24", 30", 36"**

Part Number	Brushcat Rotary Cutter Description	SLP in US\$	Discount Percent	Labor	Price
-------------	------------------------------------	-------------	------------------	-------	-------

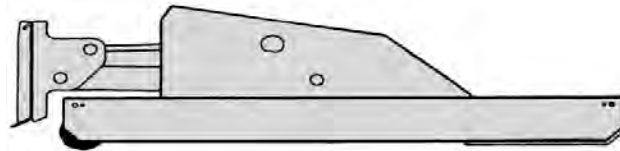

(V417)

7218087

**72" Brushcat Rotary Cutter (RC72) Std Flow**

(Comes standard with 3" Offset Blades and Front Discs Assembled) (Cutting height of 3")

\$6,295.00

24.0%

\$0.00

\$4,784.20

Part Number	Bucket Description	SLP in US\$	Discount Percent	Labor	Price
-------------	--------------------	-------------	------------------	-------	-------

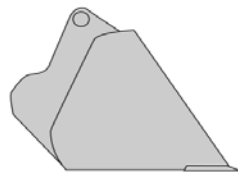

*General Purpose Bucket*

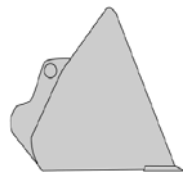

*Light Material Bucket*

(V417)

7140706

**72" General Purpose Bucket**

(Holes predrilled to accept bolt-on teeth & bolt-on cutting edge)

\$2,025.00

24.0%

\$0.00

\$1,539.00

7140711	<b>84" Light Material Bucket</b> (Holes predrilled to accept bolt-on cutting edge)	\$3,220.00	24.0%	\$0.00	\$2,447.20
---------	---	------------	-------	--------	------------

Part Number	Combination Bucket Description	SLP in US\$	Discount Percent	Labor	Price
-------------	--------------------------------	-------------	------------------	-------	-------

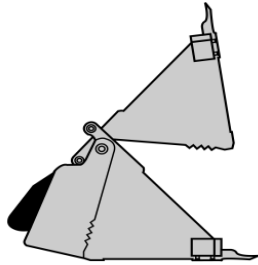

(V417)					
7167312	<b>74" Combination Bucket</b>	\$3,410.00	24.0%	\$0.00	\$2,591.60
(V417)					
7167313	<b>80" Combination Bucket</b>	\$4,080.00	24.0%	\$0.00	\$3,100.80
(V417)					
7167314	<b>84" Combination Bucket</b>	\$4,565.00	24.0%	\$0.00	\$3,469.40

◆ Buckets have holes predrilled to accept bolt-on teeth.  
All Buckets have holes predrilled to accept bolt-on cutting edges.

Part Number	Dozer Blade Description	SLP in US\$	Discount Percent	Labor	Price
-------------	-------------------------	-------------	------------------	-------	-------

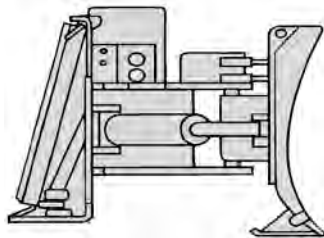

(V417 with Cab)

7105781	96" Dozer Blade, 6-Way	\$6,250.00	24.0%	\$0.00	\$4,750.00
---------	------------------------	------------	-------	--------	------------

Part Number	Grapple, Industrial Description	SLP in US\$	Discount Percent	Labor	Price
-------------	---------------------------------	-------------	------------------	-------	-------

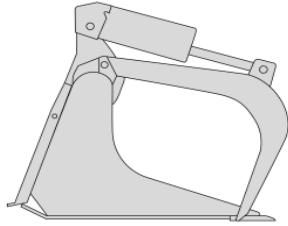

*Industrial Bucket Grapple*

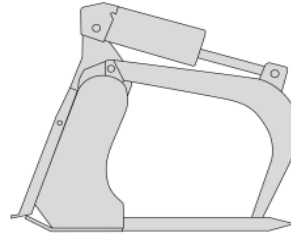

*Industrial Fork Grapple*

(V417) 7168290	74" Industrial Bucket Grapple (Bolt-On Cutting Edge included)	\$3,585.00	24.0%	\$0.00	\$2,724.60
-------------------	--	------------	-------	--------	------------

(V417) 7166624	78" Industrial Fork Grapple, with 8 teeth	\$5,095.00	24.0%	\$0.00	\$3,872.20
-------------------	---	------------	-------	--------	------------

(V417) 7168339	80" Industrial Bucket Grapple (Bolt-On Cutting Edge included)	\$4,895.00	24.0%	\$0.00	\$3,720.20
-------------------	--	------------	-------	--------	------------

Part Number	Grapple, Root Description	SLP in US\$	Discount Percent	Labor	Price
-------------	---------------------------	-------------	------------------	-------	-------

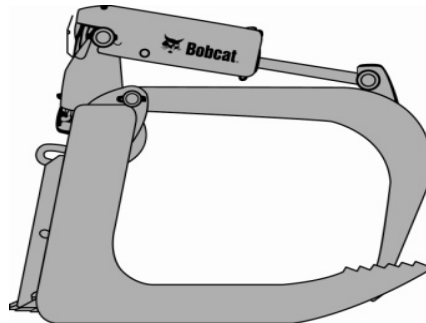

(V417) 7165486	72" Root Grapple	\$3,290.00	24.0%	\$0.00	\$2,500.40
(V417) 7168338	82" Root Grapple	\$3,605.00	24.0%	\$0.00	\$2,739.80

Part Number	Landscape Rake Description	SLP in US\$	Discount Percent	Labor	Price
-------------	----------------------------	-------------	------------------	-------	-------

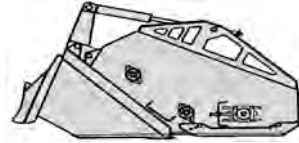

(V417) 6710630	6B Landscape Rake	\$7,635.00	24.0%	\$0.00	\$5,802.60
-------------------	-------------------	------------	-------	--------	------------

Part Number	Mower, Finish Description	SLP in US\$	Discount Percent	Labor	Price
-------------	---------------------------	-------------	------------------	-------	-------

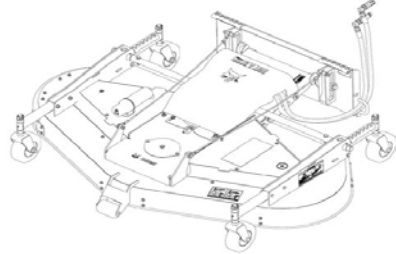

(V417) 7144850	72" Mower	\$4,895.00	24.0%	\$0.00	\$3,720.20
-------------------	-----------	------------	-------	--------	------------

(V417) 7143993	90" Mower	\$5,355.00	24.0%	\$0.00	\$4,069.80
-------------------	-----------	------------	-------	--------	------------

Part Number	Pallet Forks Description	SLP in US\$	Discount Percent	Labor	Price
-------------	--------------------------	-------------	------------------	-------	-------



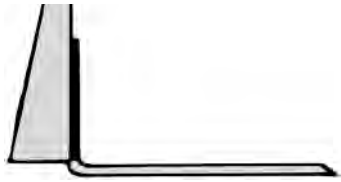

Standard Pallet Fork Teeth and Frame

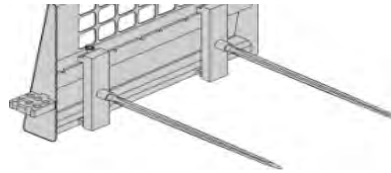

Bale Forks and Frame

(V417) 7109332	Pallet Fork Frame, Heavy Duty, less teeth		\$1,150.00	24.0%	\$0.00	\$874.00
		<u>Bale Forks</u>				
6815781	Bale Forks, Set of 2		\$610.00	24.0%	\$0.00	\$463.60
		<u>Pallet Forks</u>				
6541521	42" Pallet Fork Teeth, Set of 2		\$520.00	24.0%	\$0.00	\$395.20
6541518	48" Pallet Fork Teeth, Set of 2		\$550.00	24.0%	\$0.00	\$418.00

Part Number	Pallet Fork - Floating Description	SLP in US\$	Discount Percent	Labor	Price
-------------	------------------------------------	-------------	------------------	-------	-------

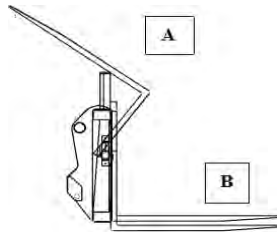

A – Lowback Forks will float and pivot up    B - Highback Forks will float only

(V417) 7140717	48" Pallet Fork Frame, less teeth		\$1,690.00	24.0%	\$0.00	\$1,284.40
6810302	48" Lowback Pallet fork Teeth, set of 2		\$875.00	24.0%	\$0.00	\$665.00
6810301	48" Highback Pallet fork Teeth, set of 2		\$1,025.00	24.0%	\$0.00	\$779.00

Part Number	Rock Bucket Description	SLP in US\$	Discount Percent	Labor	Price
-------------	-------------------------	-------------	------------------	-------	-------



(V417)

7185945	74" Rock Bucket	\$1,510.00	24.0%	\$0.00	\$1,147.60
7185947	82" Rock Bucket	\$1,650.00	24.0%	\$0.00	\$1,254.00

Bobcat Rock Buckets work excellent for separating unwanted objects, such as rocks and other debris, from work areas while leaving finer material behind that can be cultivated or landscaped. Each tine tip is fully gusseted on each side, and connected to the tip next to it. This allows the Bobcat Rock Bucket to be used effectively as a tool to clear the soil surface of vegetation or other debris, as well as to be used to pull up objects from below the ground surface.

Part Number	Seeder Description	SLP in US\$	Discount Percent	Labor	Price
-------------	--------------------	-------------	------------------	-------	-------

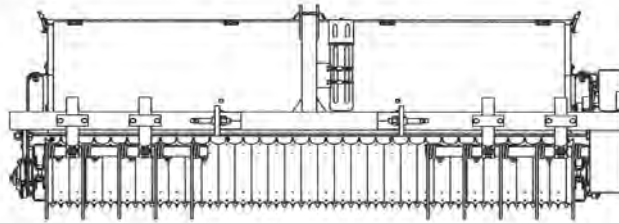

(V417)

7167712	Seeder, 72", 3PT Mounting (Must also order Bob-Tach adapter)	\$6,720.00	24.0%	\$0.00	\$5,107.20
---------	---	------------	-------	--------	------------

Part Number	Accessories Description	SLP in US\$	Discount Percent	Labor	Price
-------------	-------------------------	-------------	------------------	-------	-------

7167758	Bob-Tach Adapter (Allows Seeder to mount on Bob-Tach equipped machines)	\$665.00	24.0%	\$0.00	\$505.40
---------	--	----------	-------	--------	----------

Part Number	Scraper Description	SLP in US\$	Discount Percent	Labor	Price
-------------	---------------------	-------------	------------------	-------	-------

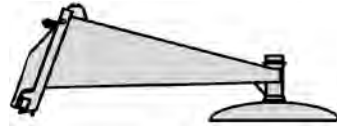

(V417) 6675211	Scraper	\$1,130.00	24.0%	\$0.00	\$858.80
-------------------	---------	------------	-------	--------	----------

Part Number	Snow Blade Description	SLP in US\$	Discount Percent	Labor	Price
-------------	------------------------	-------------	------------------	-------	-------



(V417) 7207861	86" Snow Blade – Heavy Duty (with hydraulic angle)	\$3,715.00	24.0%	\$0.00	\$2,823.40
-------------------	--	------------	-------	--------	------------

(V417) 7207862	96" Snow Blade – Heavy Duty (with hydraulic angle)	\$3,809.00	24.0%	\$0.00	\$2,894.84
-------------------	--	------------	-------	--------	------------

(V417) 7207863	108" Snow Blade – Heavy Duty (with hydraulic angle)	\$4,168.00	24.0%	\$0.00	\$3,167.68
-------------------	---	------------	-------	--------	------------

Part Number	Snow Pusher Description	SLP in US\$	Discount Percent	Labor	Price
-------------	-------------------------	-------------	------------------	-------	-------



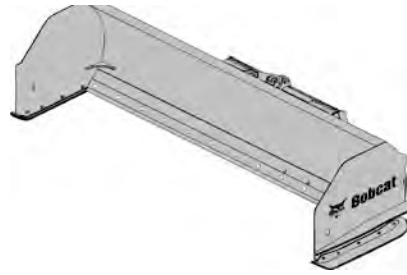

(V417) 7113767	Snow Pusher, 8'	\$3,095.00	24.0%	\$0.00	\$2,352.20
(V417) 7116164	Snow Pusher, 10'	\$3,405.00	24.0%	\$0.00	\$2,587.80

Part Number	Snow V-Blade Description	SLP in US\$	Discount Percent	Labor	Price
-------------	--------------------------	-------------	------------------	-------	-------



Blade in "V" Configuration

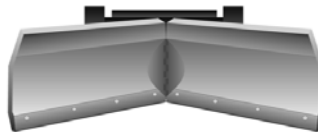

Blade in "Scoop" Configuration

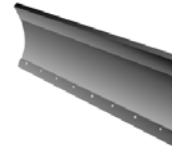

Blade in "Angled" Configuration

(V417 with Cab) 6958577	84" Snow V-Blade	\$4,255.00	24.0%	\$0.00	\$3,233.80
(V417 with Cab) 6958578	96" Snow V-Blade	\$4,350.00	24.0%	\$0.00	\$3,306.00
(V417 with Cab) 6958579	108" Snow V-Blade	\$4,445.00	24.0%	\$0.00	\$3,378.20

Part Number	Accessories - factory installed Description	SLP in US\$	Discount Percent	Labor	Price
-------------	---	-------------	------------------	-------	-------

7102606	<b>Blade Flotation Option</b> (Allows blade to oscillate +/- 10 degrees, includes pin to lock in place at 0 degrees) (Approved for use with 84", 96" and 108" Snow V-Blades)	\$835.00	24.0%	\$0.00	\$634.60
---------	--	----------	-------	--------	----------

(The frame flotation mounts between the existing frame and blade and will extend the overall blade length eight-inches from the Bob-Tach.)

Part Number	Snowblower Description	SLP in US\$	Discount Percent	Labor	Price
-------------	------------------------	-------------	------------------	-------	-------

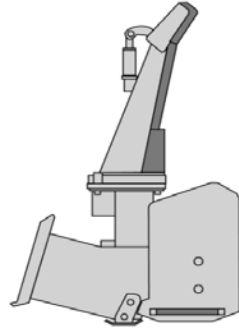

Part Number	SB200 Snowblower Description	SLP in US\$	Discount Percent	Labor	Price
-------------	------------------------------	-------------	------------------	-------	-------

*\*Must order both the Hydraulic Motor Package and the Snowblower*

(V417 with Cab)

M7004	SB200 x 78" Snowblower	\$4,850.00	24.0%	\$0.00	\$3,686.00
M7004-R01-C03	8.0 Hydraulic Motor Package	\$1,125.00	24.0%	\$0.00	\$855.00

Part Number	SB240 Snowblower Description	SLP in US\$	Discount Percent	Labor	Price
-------------	------------------------------	-------------	------------------	-------	-------

*\*Must order both the Hydraulic Motor Package and the Snowblower*

(V417 with Cab)

M7005	SB240 x 72" Snowblower	\$6,120.00	24.0%	\$0.00	\$4,651.20
M7005-R01-C03	8.0 Hydraulic Motor Package	\$1,125.00	24.0%	\$0.00	\$855.00
M7006	SB240 x 84" Snowblower	\$6,250.00	24.0%	\$0.00	\$4,750.00
M7006-R01-C03	8.0 Hydraulic Motor Package	\$1,125.00	24.0%	\$0.00	\$855.00

Part Number	Soil Conditioner Description	SLP in US\$	Discount Percent	Labor	Price
-------------	------------------------------	-------------	------------------	-------	-------

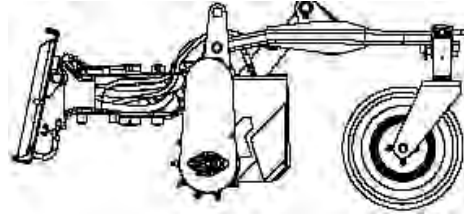

(V417 with Cab)  
7135946

84" Soil Conditioner, Hydraulic Angle

\$9,190.00 24.0% \$0.00 \$6,984.40

Part Number	Sweeper Description	SLP in US\$	Discount Percent	Labor	Price
-------------	---------------------	-------------	------------------	-------	-------

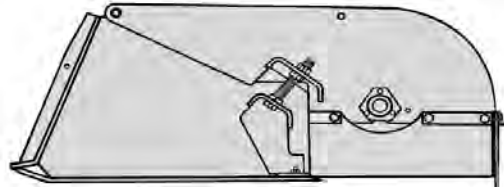

(V417)  
7112646

84" Sweeper

\$4,700.00 24.0% \$0.00 \$3,572.00

Part Number	Accessories Description	SLP in US\$	Discount Percent	Labor	Price
-------------	-------------------------	-------------	------------------	-------	-------

7122418

**Gutter Brush**  
(Includes hoses, couplers, steel bristles, mounting frame, hardware and control valve)  
(Price includes \$270 for installation)

\$1,260.00 24.0% \$270.00 \$1,227.60

Part Number	Tiller Description	SLP in US\$	Discount Percent	Labor	Price
-------------	--------------------	-------------	------------------	-------	-------

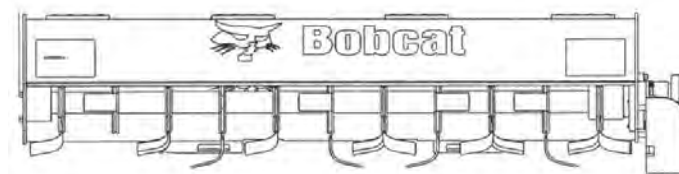

(V417)  
7102125

76" Rotary Tiller

\$5,640.00 24.0% \$0.00 \$4,286.40

Part Number	Tilt Carriage Frame Description	SLP in US\$	Discount Percent	Labor	Price
-------------	---------------------------------	-------------	------------------	-------	-------

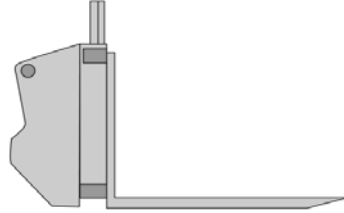

(V417) 7140720	48" Tilt Carriage Frame (less teeth)	\$3,130.00	24.0%	\$0.00	\$2,378.80
6810302	48" Lowback Pallet fork Teeth, set of 2	\$875.00	24.0%	\$0.00	\$665.00
6810301	48" Highback Pallet fork Teeth, set of 2	\$1,125.00	24.0%	\$0.00	\$855.00

Part Number	LT313 Trencher Description	SLP in US\$	Discount Percent	Labor	Price
-------------	----------------------------	-------------	------------------	-------	-------

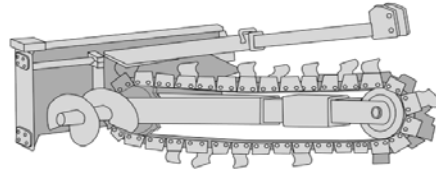

(V417) M7015	<b>LT313 Trencher</b> (Includes 3' depth, manual sideshift, 6" trench cleaner) (Can only order one factory installed chain option per trencher model)	\$4,475.00	24.0%	\$0.00	\$3,401.00
<i>All chains are 2.0" Double Standard (DS) Anti-Back Flex (ABF)</i>					
M7015-R01-C02	3' x 6" Cup Teeth in Single Standard Pattern	\$620.00	24.0%	\$0.00	\$471.20
M7015-R01-C05	3' x 8" Cup Teeth in Single Standard Pattern	\$655.00	24.0%	\$0.00	\$497.80
M7015-R01-C01	3' x 6" Cup Teeth in Double Standard Pattern	\$1,030.00	24.0%	\$0.00	\$782.80
M7015-R01-C04	3' x 6" Shark Tooth/Cup Teeth in Double Standard Pattern	\$1,040.00	24.0%	\$0.00	\$790.40
M7015-R01-C03	3' x 6" Cup & Carbide Teeth in Double Standard Pattern	\$1,685.00	24.0%	\$0.00	\$1,280.60
M7015-R01-C06	3' x 8" Cup & Carbide Teeth in Double Standard Pattern	\$1,725.00	24.0%	\$0.00	\$1,311.00
M7015-A01-C01	Hydraulic Side Shift	\$655.00	24.0%	\$0.00	\$497.80

*The LT313 is assembled as a 4' dig depth when ordering the 4' chain option  
(Boom Guide included with 4' factory installed chain)*

M7015-R01-C08	4' x 6" Cup Teeth in Single Standard Pattern	\$765.00	24.0%	\$0.00	\$581.40
M7015-R01-C11	4' x 8" Cup Teeth in Single Standard Pattern	\$860.00	24.0%	\$0.00	\$653.60
M7015-R01-C07	4' x 6" Cup Teeth in Double Standard Pattern	\$945.00	24.0%	\$0.00	\$718.20
M7015-R01-C10	4' x 6" Shark Tooth/Cup Teeth in Double Standard Pattern	\$1,220.00	24.0%	\$0.00	\$927.20
M7015-R01-C09	4' x 6" Cup & Carbide Teeth in Double Standard Pattern	\$1,890.00	24.0%	\$0.00	\$1,436.40
M7015-R01-C12	4' x 8" Cup & Carbide Teeth in Double Standard Pattern	\$2,020.00	24.0%	\$0.00	\$1,535.20
M7015-A01-C01	Hydraulic Side Shift	\$655.00	24.0%	\$0.00	\$497.80

Part Number	Truss Boom Description	SLP in US\$	Discount Percent	Labor	Price
-------------	------------------------	-------------	------------------	-------	-------

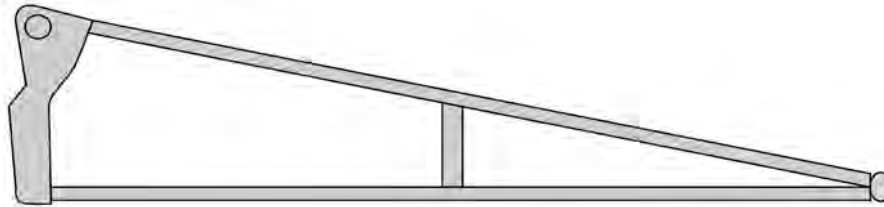

(V417) 7140714	<b>12' Truss Boom</b> (Truss Broom is outfitted with Bobtach tabs to prevent use on any carrier other than V417)	\$1,710.00	24.0%	\$0.00	\$1,299.60
-------------------	---	------------	-------	--------	------------