

MATCHLINE - STA. 185+00 - SEE SHEET L605

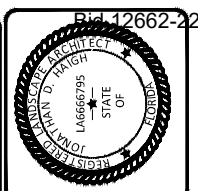
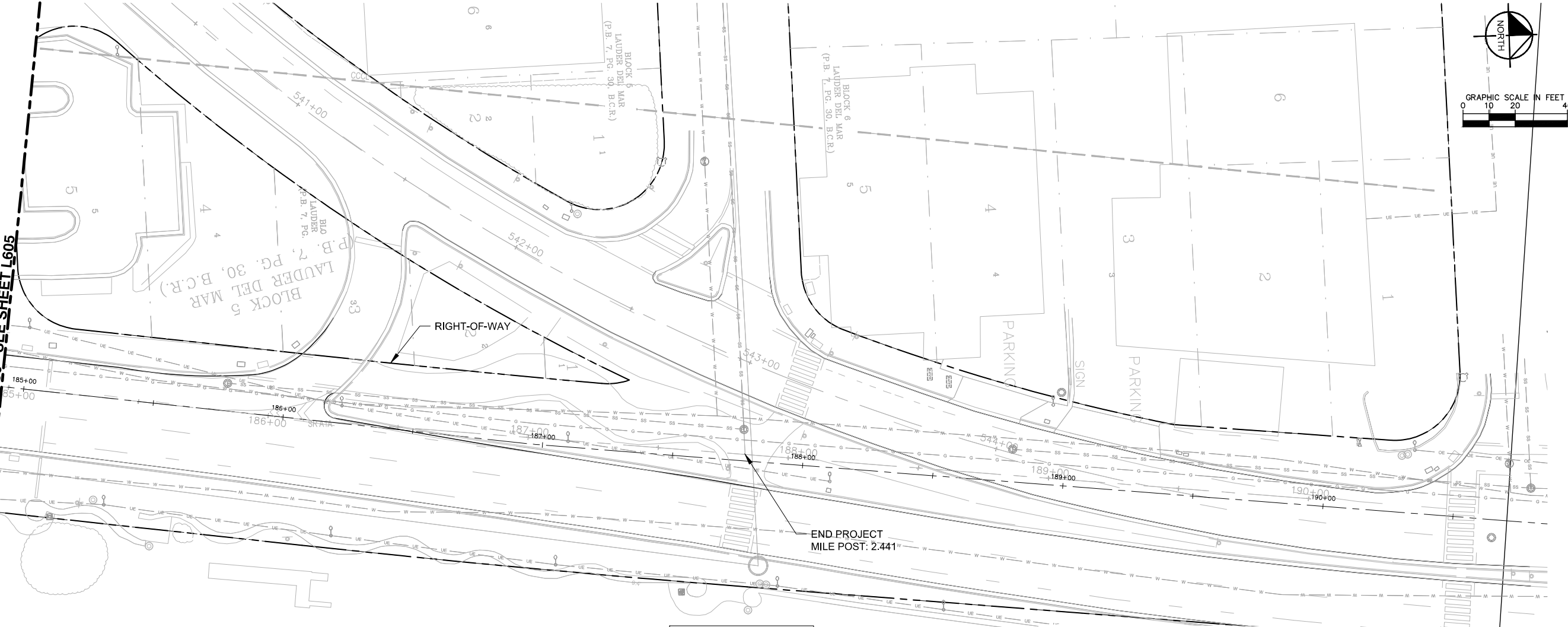

Kimley-Horn
 1000 S. BOULEVARD AVE. SUITE 100
 DELRAY BEACH, FL 33445
 PHONE: 561-320-2200 FAX: 561-320-2240
 WWW.KIMLEY-HORN.COM CA 0000096

JONATHAN D. HAIGH, P.L.A.
 LA #666795

DRAWN BY:	DATE:	DESIGNED BY:	SCALE:
	JUNE, 2022		
CHECKED BY:			

CITY OF FORT LAUDERDALE
 PUBLIC WORKS DEPARTMENT
 ENGINEERING & ARCHITECTURE
 100 North Andrews Avenue, Fort Lauderdale, Florida 33301

REVISIONS		DESCRIPTION
NO.	DATE	BY / CHK'D

IRRIGATION SCHEDULE

SYMBOL	MANUFACTURER/MODEL/DESCRIPTION	QTY	PSI
▲ 1401 ▲ 1402 ▲ 1404 ▲ 1408	Rain Bird 1402 Flood Bubbler 1401 Install on IPS Flex Hose Per Detail	82	30
SYMBOL	MANUFACTURER/MODEL/DESCRIPTION	QTY	
●	Rain Bird PEB 1", 1-1/2", 2" Plastic Industrial Valves. Low Flow Operating Capability, Globe Configuration.	2	
Ⓟ	Backflow Preventer 2" Install per City of Ft Lauderdale Utility Standards	1	
Ⓢ	Rain Bird ESPBLXME 20 Station Capable Commercial Controller. Mounted in a Stainless Steel Metal Pedestal for ESP-LX Controllers. Model LXMMSSPED	1	
Ⓡ	Hunter MINI-CLIK Rain Sensor, mount as noted	1	
Ⓜ	Water Meter 2" Location to be Confirmed with Owner. Install per City of Ft Lauderdale Utility Standards	1	
—	Irrigation Lateral Line: PVC Class 200 SDR 21	± 1,158 Lf.	
---	Irrigation Mainline: PVC Schedule 40	± 336.6 Lf.	
----	Pipe Sleeve: PVC Schedule 40	AS NEEDED	

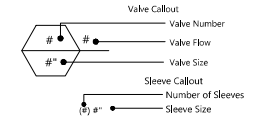

VALVE SCHEDULE

NUMBER	MODEL	SIZE	TYPE	GPM	PSI	PSI @ POC	PRECIP
1	Rain Bird PEB	1"	Bubbler	16.00	38.1	49.81	1.87 in/h
2	Rain Bird PEB	1-1/2"	Bubbler	25.00	39.74	51.69	1.98 in/h

IRRIGATION SYSTEM NOTES

- CONTRACTOR SHALL REFER TO THE IRRIGATION DETAILS, IRRIGATION SCHEDULE, SPECIFICATIONS AND ALL CONTRACT DOCUMENTS FOR FURTHER AND COMPLETE INSTRUCTIONS.
- IRRIGATION QUANTITIES ARE PROVIDED FOR CONVENIENCE. IN THE EVENT OF QUANTITY DISCREPANCIES THE DRAWING SHALL TAKE PRECEDENCE. ANY DISCREPANCIES SHALL BE BROUGHT TO THE ATTENTION OF THE LANDSCAPE ARCHITECT PRIOR TO BIDDING.
- ANY SUBSTITUTIONS FOR SPECIFIED IRRIGATION EQUIPMENT MUST BE APPROVED BY THE LANDSCAPE ARCHITECT OR OWNER'S REPRESENTATIVE IN WRITING PRIOR TO CONSTRUCTION.
- CONTRACTOR SHALL FIELD ADJUST LOCATION OF IRRIGATION EQUIPMENT AS NECESSARY TO AVOID DAMAGE TO EXISTING UNDERGROUND UTILITIES AND/OR INTERFERE WITH EXISTING ABOVE GROUND ELEMENTS. ALL FIELD ADJUSTMENTS SHALL BE COMPLETED AT THE CONTRACTOR'S EXPENSE AND SHALL BE COORDINATED WITH THE OWNER'S REPRESENTATIVE AND THE LANDSCAPE ARCHITECT.
- CONTRACTOR SHALL FAMILIARIZE HIM/HERSELF WITH THE LIMITS OF WORK AND EXISTING CONDITIONS AND VERIFY ALL INFORMATION. IF DISCREPANCIES EXIST, CONTRACTOR SHALL NOTIFY OWNER'S REPRESENTATIVE IN WRITING WITHIN SEVEN CALENDAR DAYS OF NOTICE TO PROCEED.
- IRRIGATION PLAN IS DIAGRAMMATIC. EQUIPMENT SHOWN ON IMPERVIOUS SURFACES IS FOR GRAPHIC CLARITY UNLESS OTHERWISE NOTED. CONTRACTOR SHALL INSTALL ALL EQUIPMENT WITHIN LANDSCAPE AREAS IN PROPERTY LIMITS.
- THE FDOT REQUIRES 24-HOUR EMERGENCY ACCESS TO WATER SOURCE.
- CONTRACTOR SHALL PROVIDE THE FDOT DISTRICT OPERATIONS MANAGER WITH A SET OF "AS-BUILT" IRRIGATION PLANS.

THE IRRIGATION SYSTEM IS DESIGNED TO OPERATE WITH A SOURCE PROVIDING 30 GPM AT 40 PSI.
 BUBBLER DESIGN PRESSURE: 30 PSI

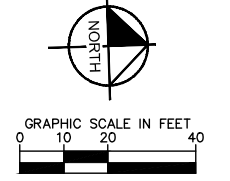
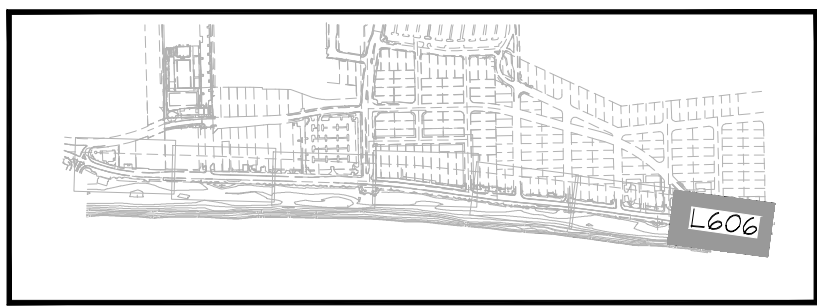

Always call 811 two full business days before you dig to have underground utilities located and marked.
Sunshine811.com

PROJECT #11881
 AIA STREETScape IMPROVEMENTS
 FORT LAUDERDALE, FL
IRRIGATION PLAN

SHEET NO.	1 OF 00
L606	

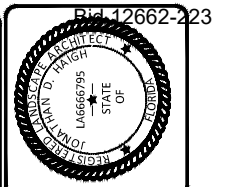

JONATHAN D. HAIGH, P.L.A.
LA #6666795

DATE: JUNE, 2022
DESIGNED BY: SCALE:
CHECKED BY:
FIELD BOOK:

CITY OF FORT LAUDERDALE
PUBLIC WORKS DEPARTMENT
ENGINEERING & ARCHITECTURE
100 North Andrews Avenue, Fort Lauderdale, Florida 33301

NO.	DATE	BY	CHK'D	DESCRIPTION

PROJECT #11681
AIA STREETSCAPE IMPROVEMENTS
FORT LAUDERDALE, FL
IRRIGATION DETAILS

SHEET NO. **L607** 1 OF 00

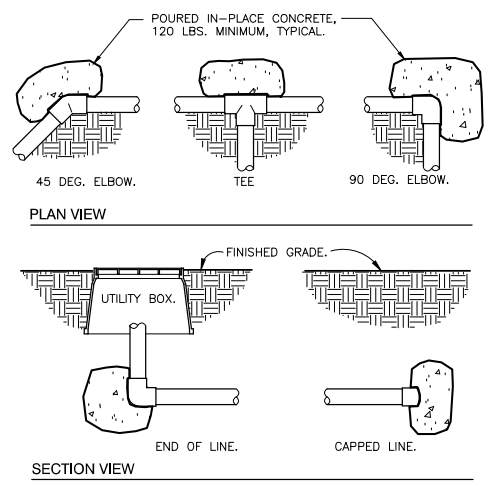

1 THRUST BLOCKING
3/4" = 1'-0" 32 8409.76-01

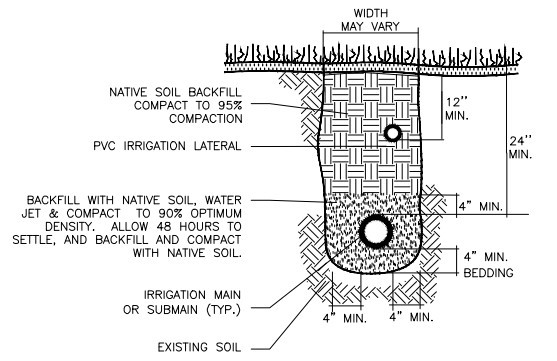

2 TRENCHING DETAIL
NOT TO SCALE 32 8409.76-03

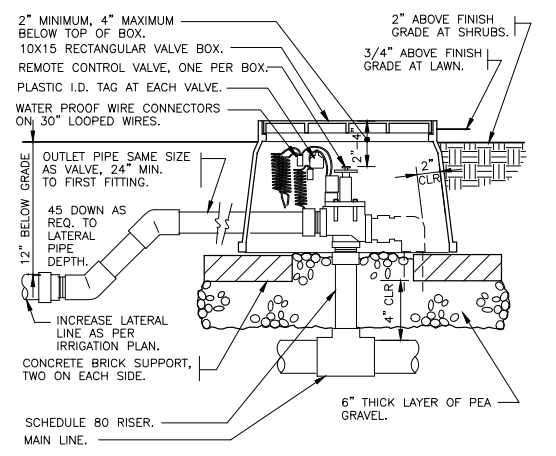

3 ELECTRIC REMOTE CONTROL VALVE
1 1/2" = 1'-0" 32 8406.13-01

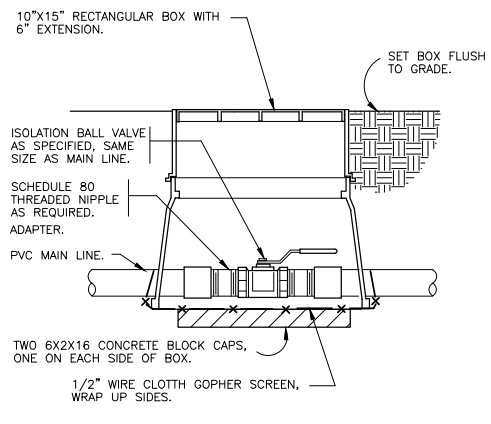

4 BRASS BALL ISOLATION VALVE
1 1/2" = 1'-0" 32 8406.33-02

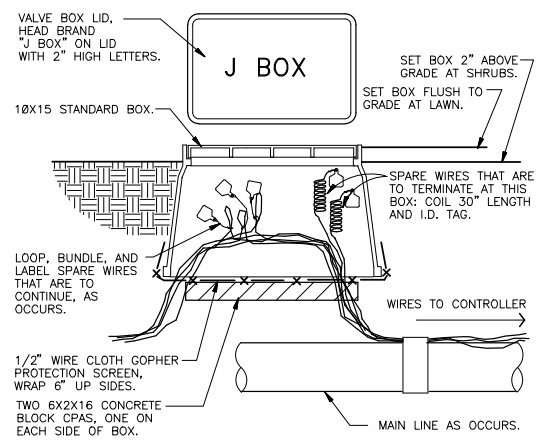

5 WIRE BUNDLE JUNCTION BOX
1 1/2" = 1'-0" 32 8409.79-01

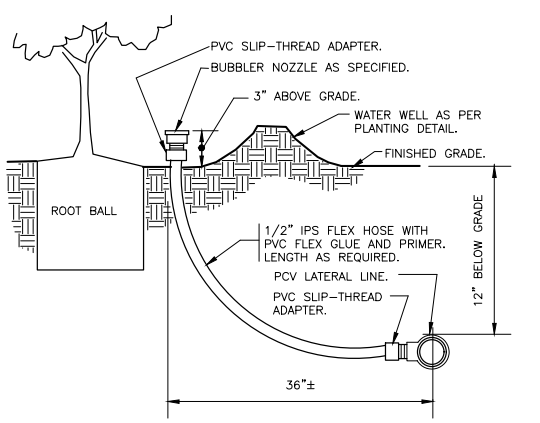

6 BUBBLER ON FLEX HOSE RISER
3" = 1'-0" DETAIL-FILE

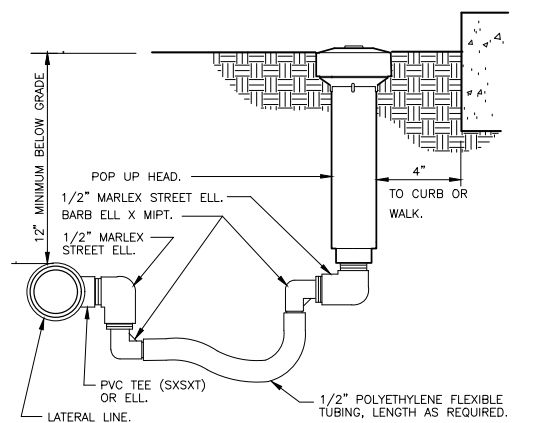

7 POP-UP SPRAY FLEX ASSEMBLY
3" = 1'-0" 32 8403.13-02

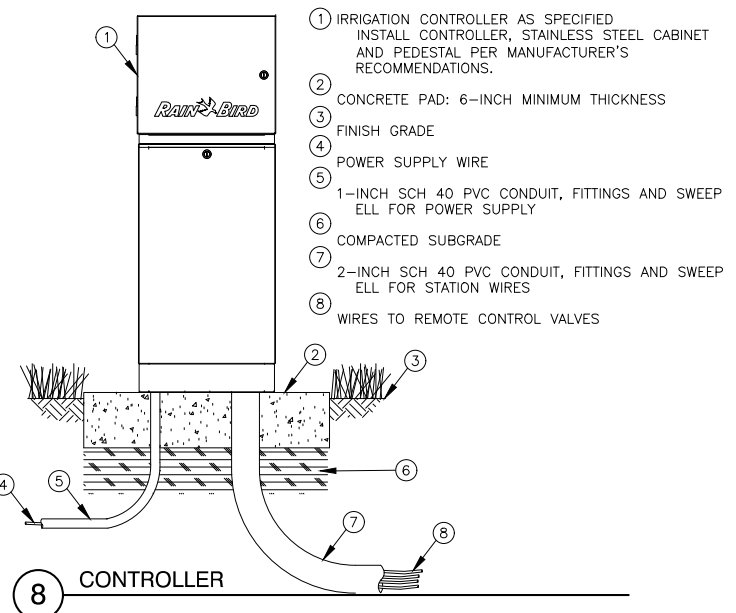

8 CONTROLLER

- 1 IRRIGATION CONTROLLER AS SPECIFIED. INSTALL CONTROLLER, STAINLESS STEEL CABINET AND PEDESTAL PER MANUFACTURER'S RECOMMENDATIONS.
- 2 CONCRETE PAD: 6-INCH MINIMUM THICKNESS
- 3 FINISH GRADE
- 4 POWER SUPPLY WIRE
- 5 1-INCH SCH 40 PVC CONDUIT, FITTINGS AND SWEEP ELL FOR POWER SUPPLY
- 6 COMPACTED SUBGRADE
- 7 2-INCH SCH 40 PVC CONDUIT, FITTINGS AND SWEEP ELL FOR STATION WIRES
- 8 WIRES TO REMOTE CONTROL VALVES

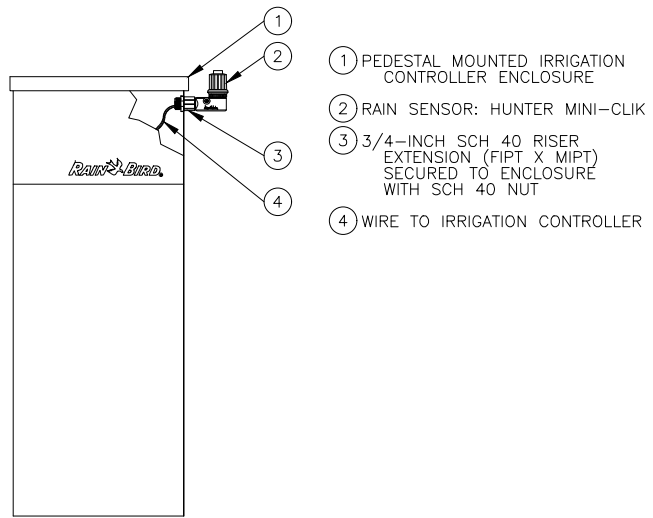

9 RAIN SENSOR
3" = 1'-0"

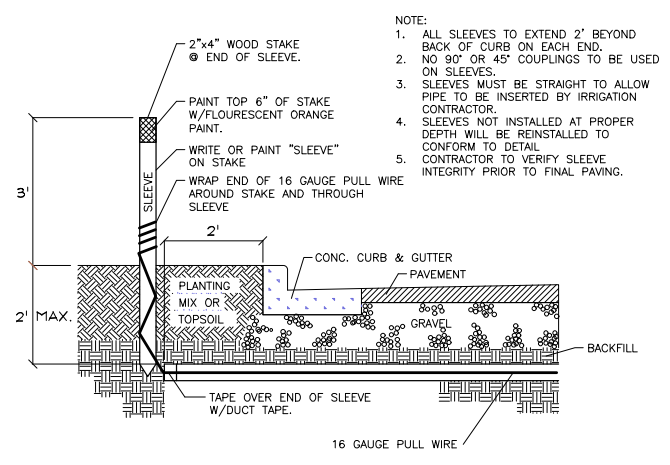

10 IRRIGATION SLEEVING
NTS

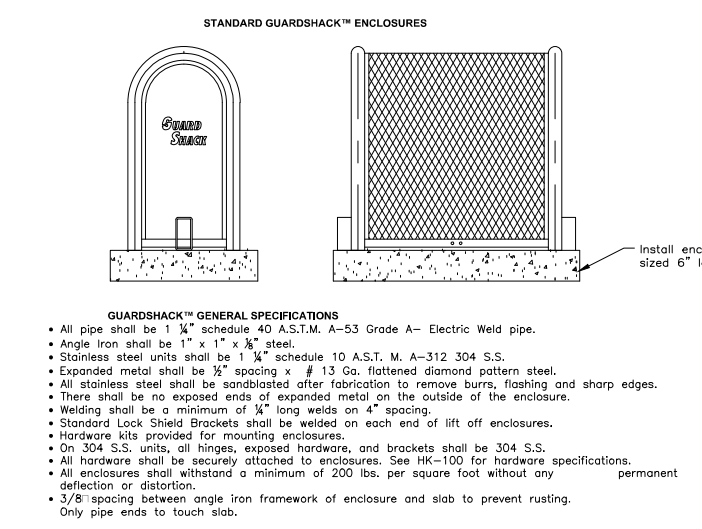

11 GUARDSHACK ENCLOSURE
NTS

Always call 811 two full business days before you dig to have underground utilities located and marked.

Sunshine811.com

document, together with the concepts and designs presented herein, as an instrument of service, is intended only for the specific purpose and client for which it was prepared. Reuse of and improper reliance on this document without written authorization and adaptation by Kimley-Horn and Associates, Inc. shall be without liability to Kimley-Horn and Associates, Inc.

UNDERGROUND IRRIGATION SYSTEM

PART I: GENERAL
1.01 SCOPE

- A. The work covered by this specification shall include the furnishing of all labor, materials, tools and equipment necessary to perform and complete the installation of an automatic irrigation system as specified herein and as shown on the drawings and any incidental work not shown or specified which can reasonably be determined to be part of the work and necessary to provide a complete and functional system.
B. The work covered by this specification also includes all permits, federal, state and local taxes and all other costs, both foreseeable and unforeseeable at the time of construction.
C. No deviation from these specifications, the accompanying drawings, or agreement is authorized or shall be made without prior written authorization signed by the Owner or his duly appointed representative.
1.02 QUALITY ASSURANCE
A. Installer Qualifications: A firm specializing in irrigation work with not less than five (5) years of experience in installing irrigation systems similar to those required for this project.
B. Coordination: Coordinate and cooperate with other contractors to enable the work to proceed as rapidly and efficiently as possible.
C. Inspection of Site: The Contractor shall acquaint himself with all site conditions, including underground utilities before construction is to begin. Contractor shall coordinate placement of underground materials with contractors previously working underground in the vicinity or those scheduled to do underground work in the vicinity. Contractor is responsible for minor adjustments in the layout of the work to accommodate existing facilities.
D. Protection of Existing Plants and Site Conditions: The Contractor shall take necessary precautions to protect site conditions to remain. Should damages be incurred, this Contractor shall repair the damage to its original condition at his own expense.
E. Protection of Work and Property: The Contractor shall be liable for and shall take the following actions as required with regard to damage to any of the Owner's property.
1. Any existing building, equipment, piping, pipe coverings, electrical systems, sewers, sidewalks, roads, grounds, landscaping or structure of any kind (including without limitation, damage from leaks in the piping system being installed or having been installed by Contractor) damaged by the Contractor, or by his agents, employees, or subcontractors, during the course of his work, whether through negligence or otherwise, shall be replaced or repaired by Contractor at his own expense in a manner satisfactory to Owner, which repair or replacement shall be a condition precedent to Owner's obligation to make final payment under the Contract.
2. Contractor shall also be responsible for damage to any work covered by these specifications before final acceptance of the work. He shall securely cover all openings into the systems and cover all apparatus, equipment and appliances, both before and after being set in place to prevent obstructions on the pipes and the breakage, misuse or disfigurement of the apparatus, equipment or appliance.
3. All trenching or other work under the leaf canopy of any and all trees shall be done by hand or by other methods so that no branches are damaged in any way. Buildings, walks, walls, and other property shall be protected from damage. Open ditches left exposed shall be flagged and barricaded by the Contractor by approved means. The Contractor shall restore disturbed areas to their original condition.
4. The Contractor shall be responsible for requesting the proper utility company to stake the exact location of any underground lines including but not limited to electric, gas, telephone service, water, and cable. The Contractor shall take whatever precautions are necessary to protect these underground lines from damage. In the event damage does occur, all damage shall be completely repaired to its original condition, at no additional cost to the Owner.
5. The Contractor shall request the Owner, in writing, to locate any private utilities (i.e., electrical service to outside lighting) before proceeding with any excavation. If, after such requests and necessary staking, private utilities which were not staked are encountered and damaged by the Contractor, they shall be repaired by the Owner at no cost to the Contractor. If the Contractor damages staked or located utilities, they shall be repaired at the Contractor's expense.
F. Codes and Inspections: The entire installation shall comply fully with all local and state laws and ordinances and with all established codes arrange for all necessary inspections and shall pay all fees and expenses in connection with same, as part of the work under this Contract. Upon completion of the work, he shall furnish to the "Owner" all inspection certificates customarily issued in connection with the class of work involved.
G. The Contractor shall keep on his work, during its progress, a competent superintendent and any necessary assistants, all satisfactory to the Owner, or Owner's representative.
H. The superintendent shall represent the Contractor in his absence and all directions given to him shall be as binding as if given to the Contractor.
I. The Owner's Landscape Architect or designated individual shall have full authority to approve or reject work performed by the Contractor. The Owner's Authorized Representative shall also have full authority to make field changes that are deemed necessary.
J. Final Acceptance: Final acceptance of the work may be obtained from the Owner upon the satisfactory completion of all work. Acceptance by the Landscape Architect and/or Owner in no way removes the Contractor of his responsibility to make further repairs, corrections and adjustments to eliminate any deficiencies which may later be discovered.
K. Guarantee: All work shall be guaranteed for one year from date of final acceptance against all defects in material, equipment and workmanship to the satisfaction of the Owner. Repairs, if required, shall be done promptly at no cost to the Owner.
1. The guarantee shall also cover repair of damage to any part of the premises resulting from leaks or workmanship, to the satisfaction of the Owner. The Contractor shall not be responsible for work damaged by others. Repairs, if required, shall be done promptly. The guarantee shall state the name of the Owner, provide full guarantee terms, effective and termination date, name and license number of Contractor providing guarantee, address, and telephone number. It shall be signed by the chief executive of the Contractor of his liability under the guarantee. Such warranties shall only supplement the guarantee.
2. If, within ten (10) days after mailing of written notice by the Owner to the Contractor requesting repairs or replacement resulting from a breach of warranty, the Contractor shall neglect to make or undertake with due diligence to make the same, the Owner may make such repairs at the Contractor's expense; provided, however, that in the case of emergency where, in the judgment of the Owner, delay would cause serious loss or damage, repairs or replacement may be made without notice being sent to the Contractor, and Contractor shall pay the cost thereof.

- L. The Contractor shall provide full, 100% irrigation coverage in all areas designed with proposed plantings, in accordance with the site's governing permitting requirements and as designed.
M. On-site Observation: At any time during the installation of the irrigation system by the Contractor, the Owner or Landscape Architect may visit the site to observe work underway. Upon request, the Contractor shall be required to uncover specified work as directed by the Owner or material, workmanship or method of installation not meet the standards specified herein, the Contractor shall replace the work at his own expense.
N. Workmanship: All work shall be installed by qualified, skilled personnel, proficient in the trades required, in a neat, orderly, and responsible manner with recognized standards of workmanship. The Contractor shall have had considerable experience and demonstrated ability in the installation of sprinkler irrigation systems of this type.

1.04 SUBMITTALS

- All materials shall be those specified and/or approved by the Landscape Architect.
A. Product Data: After the award of the Contract and prior to beginning work, the Contractor shall submit for approval by the Owner and Landscape Architect, two copies of the complete list of materials, manufacturer's technical data, and installation instructions which he proposes to install.
B. Commence no work before approval of material list and descriptive material by the Landscape Architect.
C. Record Drawings: The Contractor shall record on reproducible, all changes that may be made during actual installation of the system. Provide controller sequencing and control valve locations.
1. Immediately upon installation of any piping, valves, wiring, sprinklers, etc., in locations other than shown on the original drawings or of sizes other than indicated, the Contractor shall clearly indicate such changes on a set of blue-line prints. Records shall be made on a daily basis. All records shall be neat and subject to the approval of the Owner.
2. The Contractor shall also indicate on the record prints the location of all wire splices, original or due to repair, that are installed underground in a location other than the controller pedestal, remote control valve box, power source or connection to a valve-in-head sprinkler.
3. These drawings shall also serve as work progress sheets. The Contractor shall make neat and legible notations thereon daily as the work proceeds, showing the work as actually installed. These drawings shall be available at all times for review and shall be kept in a location designated by the Owner's Representative.
4. Progress payment request and record drawing information must be approved by Landscape Architect before payment is made.
5. If in the opinion of the Owner or his representative, the record drawing information is not being properly or promptly recorded, construction payment may be stopped until the proper information has been recorded and submitted.
6. Before the date of the final site observation and approval, the Contractor shall deliver one set (copies) of reproducible record drawing plans and notes to the Landscape Architect. Record drawing information shall be approved by the Landscape Architect prior to submittal to Owner for final payments, including retentions.
D. Operations and Maintenance Manuals: The Contractor shall prepare and deliver to the Owner, or his designated representative within ten (10) calendar days prior to completion of construction, a hard cover binder with three rings containing the following information:
1. Index sheet stating the Contractor's address and business telephone number, list of equipment with name(2) and address(es) of local manufacturer's representative(s).
2. Catalog and parts sheets on every material and equipment installed under this Contract.
3. Complete operating and maintenance instruction on all major equipment. Include initial controller schedule and recommended schedule after establishment period.
4. Demonstrate to and provide the Owner's maintenance personnel with instructions for major equipment and show evidence in writing to the Owner, or his designated representative at the conclusion of the project that this service has been rendered.
1.05 EXPLANATION OF DRAWINGS
A. Due to the scale of the drawings, it is not possible to indicate all offsets, fittings and sleeves which may be required. The Contractor shall carefully investigate the structural and finished conditions affecting all of the work and plan his work accordingly, furnishing such offsets, fittings and sleeves as may be required to meet such conditions.
B. The drawings are generally diagrammatic and indicative of the work to be installed. The work shall be installed in such a manner as to avoid conflicts between irrigation systems, planting and architectural features. Deviations shall be brought to the Landscape Architects attention.
C. All work called for a on the drawings by notes or details shall be furnished and installed whether or not specifically mentioned in the specifications.
D. The Contractor shall not willfully install the irrigation system as shown on the drawings when it is obvious in the field that obstructions, grade differences or discrepancies in area dimensions exist that might not have been known in engineering. Such obstructions or differences should be brought to the attention of the Landscape Architect. In the event that notification is not performed, the Contractor shall assume full responsibility for any revision necessary.
E. If, in the opinion of the Landscape Architect, the labor furnished by the Contractor is incompetent, unskilled, or unreliable, his equipment inadequate, improper or unsafe, or if the Contractor shall fail to continuously and diligently execute the construction, the Landscape Architect or Owner shall, in writing, instruct the Contractor to remove all such causes of noncompliance and the Contractor shall promptly comply.
F. The Contractor shall be responsible for full and complete coverage of all irrigation areas. The Landscape Architect shall be notified of any necessary adjustments at no additional cost to the Owner. Any revisions to the irrigation system must be submitted and answered in written form, along with any change in Contract price. Layout may be modified, if necessary to obtain coverage. Spacing not to exceed 60% of the diameter.

PART II: PRODUCTS

2.01 MATERIALS

Material and equipment shall be supplied by the Contractor. No substitutions shall be allowed without the prior written approval of the Owner/Landscape Architect. The Contractor shall inspect all materials and equipment prior to installation, and defective materials shall be replaced with the proper materials and equipment. Those items used in the installation found to be defective, improperly installed or not as specified, shall be removed and the proper materials and equipment installed in the proper manner, as interpreted by the Owner/Landscape Architect. The Contractor shall remove all damaged and defective pipe and equipment from the site.

2.02 PIPING

- A. General Provisions: All materials throughout the system shall be new and in perfect condition unless otherwise directed by the Landscape Architect.
B. Polyvinyl Chloride Pipe (PVC): (Where indicated on plan, use non-potable purple piping.)
1. Laterals: PVC shall conform to the requirements of ASTM Designation D 2241, Class 1120 or 1220. All lateral piping less than 3" in diameter shall be Class 200 SDR-21.
2. Main Line Under Pressure: PVC shall conform to the requirements of ASTM Designation D 2241, Class 1120 or 1220, Schedule 40 with bell end for solvent weld connection.
3. Pipe Markings: All PVC pipe shall bear the following markings:
o Manufacturer's Name
o Nominal Pipe Size
o Schedule or Class
o Pressure Rating of PSI
o NSF (National Sanitation Foundation) Approval
o Date of Extrusion

2.04 PVC JOINTS

Joints in PVC pipe smaller than 3" shall be solvent welded in accordance with the recommendations of the pipe manufacturer; the solvent cleaner and welding compound furnished with the pipe.

2.05 THREADED CONNECTIONS

A. Threaded PVC connections shall be made up using Teflon tape only.

B. Connection between mainline pipe fittings and automatic or manual control valves shall be made using Schedule 80 threaded fittings and nipples.

2.06 SOLVENT CEMENT

A. General: Provide solvent cement and primer for PVC solvent weld pipe and fittings recommended by the manufacturer. Pipe joints for solvent weld pipe to be belled end. Pipe joints for gasketed pipe to be intrical ring type. Insert gaskets will not be accepted.

B. Thrust Blocks: Main line piping 3" or greater in diameter shall have thrust blocks sized and placed in accordance with the pipe manufacturer's recommendations or, in the absence of specified recommendations by the pipe manufacturer. 3000 PSI concrete thrusts shall be properly installed at tees, elbows, 45's, crosses, reducers, plugs, caps and valves.

2.07 PIPE AND WIRE SLEEVES

- A. Sleeves to be installed:
1. The Contractor shall install irrigation system pipe and wire sleeves conforming to the following:
a. All pipe sleeves shall extend a minimum of 36" beyond the edges of pavement.
b. All pipe sleeves to be installed beneath future/existing road surfaces shall be PVC pipe Schedule 40 or jack and bore steel pipe as per FDOT specifications, and as shown on plans.
c. All irrigation system wires shall be sleeved separately from main or lateral lines.
d. All pipe sleeves shall be installed at the minimum depth specified for main lines, lateral lines, and electric wire.
e. Contractor shall coordinate all pipe sleeve locations and depths prior to initiating installation of the irrigation system.

2.08 SPRINKLER HEADS

A. Spray Sprinklers: The sprinkler shall be a fixed spray type designed for in-ground installation. The nozzle shall elevate 6" (or as designated on plan) when in operation. The body of the sprinkler shall be constructed of non-corrosive heavy duty Gycolac. A filter screen shall be in the nozzle piston. All sprinkler parts shall be removable through the tip of the unit by removal of a threaded cap.

Riser mounted spray shall be as indicated on the plans. The sprinkler shall consist of a nozzle and body. The body of the riser-mount sprinkler shall be constructed of non-corrosive materials. A cone strainer shall be a separate part with the nozzle assembly to allow for easy flushing of the sprinkler. Maximum working pressure at the base of the sprinkler shall be 40 PSI.

(continued...)

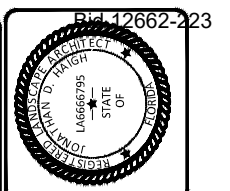

Kimley-Horn
JONATHAN D. HAIGH, PLA
LA #666795

Table with 4 columns: DATE, DESIGNED BY, CHECKED BY, FIELD BOOK. Values: JUNE, 2022; [blank]; [blank]; [blank].

CITY OF FORT LAUDERDALE
PUBLIC WORKS DEPARTMENT
ENGINEERING & ARCHITECTURE
100 North Andrews Avenue, Fort Lauderdale, Florida 33301

Table with 2 columns: NO, DATE, DESCRIPTION. Header: REVISIONS.

PROJECT #11681
AIA STREETSCAPE IMPROVEMENTS
FORT LAUDERDALE, FL
IRRIGATION NOTES

Table with 2 columns: SHEET NO., OF. Values: L608, 1 OF 00.

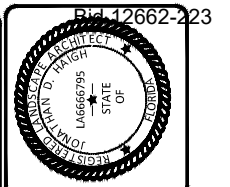

JONATHAN D. HAIGH, PLA
LA #6666795

DATE: JUNE 2022	SCALE:
DRAWN BY:	DESIGNED BY:
CHECKED BY:	FIELD BOOK:

CITY OF FORT LAUDERDALE
PUBLIC WORKS DEPARTMENT
ENGINEERING & ARCHITECTURE
100 North Andrews Avenue, Fort Lauderdale, Florida 33301

NO.	DATE	BY	CHK'D	DESCRIPTION

PROJECT #11681
AIA STREETScape IMPROVEMENTS
FORT LAUDERDALE, FL

IRRIGATION NOTES

SHEET NO. 1 OF 00
L609

PART III: EXECUTION

3.01 INSPECTION

The Contractor shall examine the areas and conditions under which landscape irrigation system is to be installed and notify the Landscape Architect in writing of conditions detrimental to the proper and timely completion of the work. The Contractor shall proceed with the work until unsatisfactory conditions have been corrected in a manner acceptable to the Landscape Architect.

3.02 PREPARATION

The Contractor shall provide sleeves to accommodate piping under walks or paving. The Contractor shall coordinate with other trades and install to accurate levels prior to paving work. Cutting and patching of paving and concrete will not be permitted. The Contractor shall maintain all warning signs, shoring, barricades, flares and red lanterns, as required by any local codes, ordinances or permits.

3.03 TRENCHING AND BACKFILLING

A. Excavation: The Contractor shall stake out the location of each run of pipe, sprinkler heads, sprinkler valves and isolation valves prior to trenching. Excavation shall be open vertical construction sufficiently wide to provide free working space around the work installed and to provide ample space or backfilling and tamping. Trenches for pipe shall be cut to required grade lines, and compacted to provide accurate grade and uniform bearing for the full length of the line. The bottom of the trenches shall be free of rock or other sharp edged objects. Minimum cover shall be as follows:

Pipe and Wire Depth

Pressure Mainline	18" at top of pipe from Finish Grade
Lateral Piping (rotor)	12" at top of pipe from Finish Grade
Lateral Piping (pop-up)	12" at top of pipe from Finish Grade
Control Wiring	Side of main Line

B. Minimum Clearances: All pipelines shall have a minimum clearance of six inches from each other and from lines of other crafts. Parallel lines shall not be installed directly over one another. No lateral line shall be installed in the main-line trench.

3.04 INSTALLATION OF PIPING

A. PVC Pipe and Joints: The Contractor shall not install solvent wild pipe when air temperature is below 40° F. Installation shall be in accordance with the manufacturer's instructions.

- Only the solvent recommended by the pipe manufacturer shall be used. All PVC pipe and fittings shall be installed as outlined and instructed by the pipe manufacturer, and it shall be the Contractor's full responsibility to make arrangements with the pipe manufacturer for any field assistance that may be necessary. The Contractor shall assume full responsibility for the correct installation.

3.05 BACKFILLING PROCEDURES

Initial backfill on PVC lines shall be pulverized native soil, free of foreign matter. Within radius of 4' of the pipe shall be clean soil or sand. Plant locations shall take precedence over sprinkler and pipe locations. The Contractor shall coordinate the location of trees and shrubs with the routing of lines and final head locations.

A. Backfill and Compaction: The Contractor shall leave trenches slightly mounded to allow for settlement after the backfilling is completed. The Contractor shall clean the site of the work continuously of excess waste materials as the backfilling progresses, and leave in a neat condition. No trenches shall be left open for a period of more than 48 hours. Protect open trenches as required.

The Contractor shall carefully backfill excavated materials approved for backfilling, consisting of earth, loam, sand, and other approved materials, free of rock and debris over 1" in size. Backfill shall be compacted to original density of surrounding soil without dips, sunken areas, or irregularities.

The Contractor shall conform to DOT requirements for methods and required compaction percentages, for roads and paving.

The Contractor shall hand place the first 6" of backfill (or to top of pipe) and have it walked on so as to secure the position of the pipe and wire.

No wheel rolling will be allowed. The Contractor shall remove rock or debris extracted from backfill materials and dispose of offsite. The Contractor shall fill any voids left in backfill with approved backfill materials.

B. Existing Lawns: Where trenching is required across existing lawns, uniformly cut strips of sod 6' wider than trench. The Contractor shall remove sod in rolls of suitable size for handling and keep moistened until replanted. The Contractor shall replant sod within 48 hours after removal, roll and water generously. The Contractor shall resod any areas not in healthy condition equal to adjoining lawns 10 days after replanting.

C. Seeded Area: Trenching will be required across existing seeded areas, primarily roadway edging. The Contractor shall conform to the requirements of seeding, Section 02930 for the reseeded of the disturbed trench area.

D. Pavements: Jack and bore or directional bore piping under paving materials as per local regulatory codes. No cutting and patching of pavement will be permitted.

3.06 VALVES

A. Isolation Valves: Shall be sized corresponding to adjacent pipe size. Specified valve boxes shall be installed flush with finish grade in such a manner that surface forces applied to their exposed area will not be transmitted to the piping in which the valve is installed nor any other piping, wiring or other lines in the vicinity of said valves.

B. Gate Valves: Install where shown, in valve boxes.

C. Electric Control Valves: Shall be installed in specified valve boxes. The valve shall have 6" of 3/4" pea gravel installed below the bottom of the valve. If the valve does not extend to the base of the valve, a valve box extension shall be installed. Electric control valves shall be installed where shown and grouped together where practical. The Contractor shall place no closer than 24" to walk edges, bikeway edges, buildings and walls. The Contractor shall adjust the valve to provide flow rate or rated operating pressure required for each sprinkler circuit.

3.07 CONDUIT AND SLEEVES

A. Conduit and Sleeves for Control Wiring and Main/Lateral Pipe: The Contractor shall provide and install where necessary. Contractor shall coordinate locations of previously installed sleeving with the General Site Contractor.

The Contractor shall coordinate installation of sleeves with work of other disciplines.

3.08 CONTROLS

A. The Contractor shall connect electric control valves to controllers in a clockwise sequence to correspond with station settings beginning with Stations 1, 2, 3, etc. Automatic controllers shall be provided and installed by the Contractor as noted on the drawings. All zones will be labeled on the controller.

B. Controllers shall be equipped with lightning protection and grounded to a standard 5/8" copper clad steel ground rod driven a minimum of 8' into the ground and clamped.

C. The electrical service to the controllers shall be performed by an electrical subcontractor in compliance with NEC requirements.

3.09 CONTROL WIRE

A. Control wiring between the controller and electric valves shall be buried in main line trenches or in separate trenches. Electrical connection at valve will allow for pigtail so solenoid can be removed from valve with sufficient slack to allow ends to be pulled 12" above ground for examination and cleaning.

B. An expansion loop shall be provided at every valve at 100' o.c. Expansion loop shall be formed by wrapping wire at least eight times around a 3/4" pipe and withdrawing pipe.

C. The wire shall be bundled and taped every ten feet. The wire shall be laid in the trench prior to installing the pipe being careful to install wire beneath and 6" to the side of the main pipe line.

D. Electrical connections to electric control valves shall be made with Rainbird Pen-Tite or Techdel GT-3-GEL - Tite connectors or equal.

Power Connections: Electrical connections to power and signal wires shall be made using 3M 82-A2 power cable splice kits.

3.10 SPRINKLER HEADS

A. General Provisions:

1. Sprinkler heads shall be installed as designated on the shop drawings. Heads shall be installed on flexible PVC. Top to be flush with finish grade or top of curb.

2. Spacing of heads shall not exceed the maximum indicated on the shop drawings (unless directed by the Landscape Architect). In no case shall the spacing exceed the maximum recommended by the manufacturer.

B. Head Types:

1. Pop-up- Rotary Sprinkler Heads: Shall be installed on flex joint and be set with top of head flush with finish grade. Heads installed at curb shall have 6" to 10" between perimeter of head and concrete. Heads placed at edge of pavement having no curb shall be installed 24" from edge of pavement.

2. Spray Pop-up Sprinkler Heads: Shall be installed on flexible PVC and be set with top of head flush with finished grade. Sprinkler heads placed adjacent to curbs will be installed 9" from concrete. Sprinkler heads placed adjacent to pavement having no curb shall be installed 24" from the edge of pavement.

3.11 COMPLETION

A. Flushing: Before sprinkler heads are set, the Contractor shall flush the lines thoroughly to make sure there is no foreign matter in the lines.

The Contractor shall flush the main lines from dead end fittings for a minimum of five minutes under a full head of pressure.

B. Testing: The Contractor shall notify Landscape Architect and Owner forty-eight (48) hours in advance of testing.

Prior to backfilling of main line fittings, Contractor shall fill the main line piping with water, in the presence of the Owner/Landscape Architect, taking care to purge the air from it by operating all the sprinkler control valves one or more times and/or such other means as may be necessary. A small, high pressure pump or other means of maintaining a continuous water supply shall be connected to the main line and set so as to maintain 100 PSI in the main line system for two (2) hours without interruption. When this has been accomplished and while the pressure in the system is still 100 PSI, leakage testing shall be performed in accordance with AWWA Standard C-600. Pressure readings shall be noted and make up water usage shall be recorded. Should the rate of make up water usage indicate significant leakage, the source of such leakage shall be found and corrected and the system then retested until the Owner/Landscape Architect is satisfied that the system is reasonably sound. Lateral line testing shall be conducted during the operating testing of the system by checking visually the ground surface until no leaks in this portion of the system are evident. Leaks shall be repaired or paid for by the Contractor at any time they appear during the warranty period.

C. Adjustment and Coverage of System: Coordinate pressure testing with adjustments and coverage test of system so both may occur at the same time. The Contractor shall balance and adjust the various components of the system so that the overall operation of the system is most efficient. This includes a synchronization of the controllers, adjustments to pressure regulators, pressure relief valves, part circle sprinkler heads, and individual station adjustments on the controllers.

3.12 WARRANTY

A. The Contractor shall fully warrant the landscape irrigation system for a period of one (1) year after the written final acceptance and will receive a written confirmation from the Landscape Architect that the warranty period is in effect.

B. During the warranty period, the Contractor will enforce all manufacturer's and supplier's warranties as if made by the Contractor himself. Any malfunctions, deficiencies, breaks, damages, disrepair, or other disorder due to materials, workmanship, or installation by the Contractor and his suppliers shall be immediately and properly corrected to the proper order as directed by the Owner and/or Landscape Architect.

C. Any damages caused by system malfunction shall be the responsibility of the Contractor who shall make full and immediate restoration for said damages.

Always call 811 two full business days before you dig to have underground utilities located and marked.

Sunshine811.com

This document, together with the concepts and designs presented herein, as an instrument of service, is intended only for the specific purpose and client for which it was prepared. Reuse of and improper reliance on this document without written authorization and adaptation by Kimley-Horn and Associates, Inc. shall be without liability to Kimley-Horn and Associates, Inc.



City of Fort Lauderdale • Procurement Services Division
100 N. Andrews Avenue, 619 • Fort Lauderdale, Florida 33301
954-828-5933 Fax 954-828-5576
purchase@fortlauderdale.gov

ADDENDUM NO. 2

ITB No. 12662-223
TITLE: SR A1A Streetscape Improvement Project

ISSUED: 7/25/22

This addendum is being issued to make the following change(s):

1. The opening date has been changed to **August 10, 2022**. The Question and Answer duration has also been extended to **August 3, 2022**

All other terms, conditions, and specifications remain unchanged.

Please note that Bldsync generated addendum 1 on July 18, 2022 to extend the opening date to July 25th.

(Insert Buyer's Name)
(Insert Buyer's Title)

Company Name: _____
(please print)

Bidder's Signature: _____

Date: _____



City of Fort Lauderdale • Procurement Services Division
 100 N. Andrews Avenue, 619 • Fort Lauderdale, Florida 33301
 954-828-5933 Fax 954-828-5576
purchase@fortlauderdale.gov

ADDENDUM NO. 3

ITB No. 12662-223
 TITLE: SR A1A Streetscape Improvement Project

ISSUED: 8/3/22

This addendum is being issued to make the following change(s):

1. In the Invitation to Bid Document, **revise the underlined Notice to bidder paragraph** as follows:

Notice to bidder: Funding for this project requires all work to be completed by September of 2023. The bidder is advised of this project need and must plan and coordinate all activity to meet the required completion date of August 31st, 2023.

2. In the Special Conditions section, **Revise 05. Contract Time**, page SC-1 as follows:

5.2 Funding for this project requires all work to be completed by September of 2023. The bidder is advised of this project need and must plan and coordinate all activity to meet the required completion date of August 31st, 2023. The Work shall be Substantially Completed within 243 calendar days after the date when Contract Time commences to run as provided in the Notice to Proceed or by August 1ST, 2023, whichever is sooner.

5.3 The Work shall be finally completed on the Final Completion Date and ready for the final payment in accordance with this Agreement within 274 calendar days or by August 31st, 2023, whichever is sooner after the date when the Contract Time commences to run as provided in the Notice to Proceed.

3. Under 08. *Specific Experience Required* section, **delete the paragraph on page SC-2** stating the following:
 Funding for this project requires all work to be completed by December 31 of 2022. The bidder is advised of this project need and must plan and



City of Fort Lauderdale • Procurement Services Division
100 N. Andrews Avenue, 619 • Fort Lauderdale, Florida 33301
954-828-5933 Fax 954-828-5576
purchase@fortlauderdale.gov

coordinate all activity to meet the required completion date of December 31st, 2022.

- 4. In the Special Conditions section, **Revise 14. Liquidated Damages** as follows:
Funding for this project requires all work to be completed by September of 2023. The bidder is advised of this project need and must plan and coordinate all activity to meet the required completion date of August 31st, 2023.
- 5. The opening date has been changed to **August 18, 2022**. The Question and Answer duration has also been extended to **August 11, 2022**.

All other terms, conditions, and specifications remain unchanged.

James Hemphill
Asst. Manager Procurement and Contracts

Company Name: _____
(please print)

Bidder's Signature: _____

Date: _____

ADDENDUM NO. 4

RFQ 12662-223

SR A1A Streetscape Improvement Project

ISSUED: 08/18/2022

This addendum is being issued to make the following change(s):

1. Opening Bid will extend to Thursday September 8,2022

All other terms, conditions, and specifications remain unchanged.

Fausto Vargas
Senior Procurement Specialist

Company Name: _____
(please print)

Bidder's Signature: _____

Date: _____

Question and Answers for Bid #12662-223 - SR A1A Streetscape Improvement Project

Overall Bid Questions

Question 1

We can supply Quality Cobra Head Led Parking lights, Post Top Halo Lights, various other designs and or ALL IN ONE LED SOLAR PARKING/AREA LIGHTS. The advantage of the all in one Led Solar lights is that there is no electrical connections and is guaranteed for 10 years battery life. Please advise We are sole Manufacturer representative. (Submitted: Jun 15, 2022 2:56:50 PM EDT)

Answer

- The proposed lights are intended to match the aesthetics of existing lighting on the east side of SR A1A and have been approved for this project by the FDOT. The lighting for this project must be in accordance with the specifications provided in the bid. The FDOT requires lighting within the FDOT right of way to be listed on the Departments approved product list (or approved through a technical specification). (Answered: Jun 16, 2022 11:57:00 AM EDT)

Question 2

What is the estimated budget for this project? (Submitted: Jun 16, 2022 12:07:04 PM EDT)

Answer

- Estimated construction cost is around \$7 - 8 million (Answered: Jun 16, 2022 1:39:43 PM EDT)

Question 3

Is this a LAP project? (Submitted: Jun 16, 2022 12:07:20 PM EDT)

Answer

- This is not a LAP project (Answered: Jun 20, 2022 1:37:09 PM EDT)

Question 4

Are there any DBE requirements? (Submitted: Jun 16, 2022 12:07:45 PM EDT)

Answer

- No - There are no DBE requirements in the JPA agreement between the City and FDOT (Answered: Jun 20, 2022 1:37:09 PM EDT)

Question 5

Will you accept bids for supply only on the lighting for this project? (Submitted: Jun 17, 2022 1:01:20 AM EDT)

Answer

- The bidders shall provide cost for all bid items as specified. (Answered: Jun 20, 2022 10:47:59 AM EDT)

